

Service Manual

Air Conditioner



Indoor Unit
 CS-Z25UB4EAW
 CS-Z35UB4EAW
 CS-Z50UB4EAW
 CS-Z60UB4EAW

Outdoor Unit
 CU-Z25UBEA
 CU-Z35UBEA
 CU-Z50UBEA
 CU-Z60UBEA

Destination
 Europe
 Turkey

Please file and use this manual together with the service manual for Model No. CU-2E12SBE, CU-2E15SBE, CU-2E18SBE, CU-3E23SBE, CU-3E18PBE, CU-4E23PBE, CU-4E27PBE, CU-5E34PBE, CU-2Z35TBE, CU-2Z41TBE, CU-2Z50TBE, CU-3Z52TBE, CU-3Z68TBE, CU-4Z68TBE, CU-4Z80TBE, CU-5Z90TBE, Order No. PAPAMY1601015CE, PAPAMY1301048CE, PAPAMY1303046CE, PAPAMY1702035CE, PAPAMY1703049CE, PAPAMY1710082CE.

⚠ WARNING

This service information is designed for experienced repair technicians only and is not designed for use by the general public. It does not contain warnings or cautions to advise non-technical individuals of potential dangers in attempting to service a product. Products powered by electricity should be serviced or repaired only by experienced professional technicians. Any attempt to service or repair the products dealt with in this service information by anyone else could result in serious injury or death.

IMPORTANT SAFETY NOTICE

There are special components used in this equipment which are important for safety. These parts are marked by ⚠ in the Schematic Diagrams, Circuit Board Diagrams, Exploded Views and Replacement Parts List. It is essential that these critical parts should be replaced with manufacturer's specified parts to prevent shock, fire or other hazards. Do not modify the original design without permission of manufacturer.

⚠ PRECAUTION OF LOW TEMPERATURE

In order to avoid frostbite, be assured of no refrigerant leakage during the installation or repairing of refrigerant circuit.

⚠ CAUTION

R32 REFRIGERANT – This Air Conditioner contains and operates with refrigerant R32.

THIS PRODUCT MUST ONLY BE INSTALLED OR SERVICED BY QUALIFIED PERSONNEL.



Refer to Commonwealth, State, Territory and local legislation, regulations, codes, installation & operation manuals, before the installation, maintenance and/or service of this product.

TABLE OF CONTENTS

	PAGE		PAGE
1. Safety Precautions	3	14.4 Airflow Direction.....	73
2. Precaution for Using R32 Refrigerant	6	14.5 Quiet Operation (Cooling Mode/Cooling Area of Dry Mode)	73
3. Specifications	10	14.6 Quiet Operation (Heating)	74
4. Features	20	14.7 Powerful Mode Operation.....	74
5. Location of Controls and Components	21	14.8 Timer Control.....	74
5.1 Indoor Unit.....	21	14.9 Auto Restart Control.....	75
5.2 Outdoor Unit	21	14.10 Indication Panel.....	75
5.3 Remote Control	21	14.11 Drain Pump Control Operation	75
6. Dimensions	22	14.12 HA Terminal (HAJEM-A)	75
6.1 Indoor Unit.....	22	15. Operation Control	
6.2 Outdoor Unit	23	(For Multi Split Connection)	77
7. Refrigeration Cycle Diagram	25	15.1 Cooling operation	77
7.1 CS-Z25UB4EAW CU-Z25UBEA		15.2 Soft Dry Operation.....	77
CS-Z35UB4EAW CU-Z35UBEA	25	15.3 Heating Operation	77
7.2 CS-Z50UB4EAW CU-Z50UBEA		15.4 Automatic Operation.....	78
CS-Z60UB4EAW CU-Z60UBEA	26	15.5 Indoor Fan Motor Operation	78
8. Block Diagram	27	15.6 Powerful Mode Operation.....	78
8.1 CS-Z25UB4EAW CU-Z25UBEA		15.7 Auto Restart Control	78
CS-Z35UB4EAW CU-Z35UBEA	27	15.8 Indication Panel.....	78
8.2 CS-Z50UB4EAW CU-Z50UBEA		16. Protection Control	79
CS-Z60UB4EAW CU-Z60UBEA	28	16.1 Protection Control for All Operations.....	79
9. Wiring Connection Diagram	29	16.2 Protection Control for Cooling & Soft Dry Operation	81
9.1 Indoor Unit.....	29	16.3 Protection Control for Heating Operation	82
9.2 Outdoor Unit	30	17. Servicing Mode	84
10. Electronic Circuit Diagram	32	17.1 Auto OFF/ON Button	84
10.1 Indoor Unit.....	32	17.2 Heat Only Operation.....	85
10.2 Outdoor Unit	33	17.3 Remote Control Button.....	86
11. Printed Circuit Board	35	18. Troubleshooting Guide	90
11.1 Indoor Unit.....	35	18.1 Refrigeration Cycle System	90
11.2 Outdoor Unit	36	18.2 Breakdown Self Diagnosis Function.....	92
12. Installation Instruction	38	18.3 Error Codes Table	93
12.1 Indoor Unit.....	38	18.4 Self-diagnosis Method.....	95
12.2 Outdoor Unit	46	19. Disassembly and Assembly Instructions ...	123
13. Installation and Servicing Air Conditioner using R32	50	19.1 Disassembly of Parts.....	123
13.1 About R32 Refrigerant.....	50	19.2 Outdoor Electronic Controller Removal Procedure	126
13.2 Characteristics of R32 Refrigerant	50	20. Technical Data	129
13.3 Refrigerant piping installation • Tools used in services.....	52	20.1 Cool Mode Performance Data.....	129
13.4 New installation, Relocation, Repairing of Refrigerant Cycle System The Procedures	56	20.2 Heat Mode Performance Data.....	131
13.5 Piping installation of R32.....	57	21. Service Data	132
13.6 Installation, Relocation, and Service	58	21.1 Cool Mode Outdoor Air Temperature Characteristic.....	132
13.7 Repairing of refrigerant cycle / Brazing point.....	62	21.2 Heat Mode Outdoor Air Temperature Characteristic.....	136
13.8 <Reference> Analysis method for no error code, no cooling / no warming.....	68	21.3 Piping Length Correction Factor.....	140
14. Operation Control	70	22. Exploded View and Replacement Parts List	142
14.1 Basic Function	70	22.1 Indoor Unit	142
14.2 Indoor Fan Motor Operation	71	22.2 CZ-BT20EW (Front Grille Complete)	148
14.3 Outdoor Fan Motor Operation	72	22.3 Outdoor Unit	150

1. Safety Precautions





- Read the following “SAFETY PRECAUTIONS” carefully before perform any servicing.
- Electrical work must be installed or serviced by a licensed electrician. Be sure to use the correct rating of the power plug and main circuit for the model installed.
- The caution items stated here must be followed because these important contents are related to safety. The meaning of each indication used is as below. Incorrect installation or servicing due to ignoring of the instruction will cause harm or damage, and the seriousness is classified by the following indications.

 WARNING	This indication shows the possibility of causing death or serious injury.
 CAUTION	This indication shows the possibility of causing injury or damage to properties.













- The items to be followed are classified by the symbols:

	This symbol denotes item that is PROHIBITED from doing.
---	---

- Explanation of symbols displayed on the indoor unit or outdoor unit.

 WARNING	This symbol shows that this equipment uses a flammable refrigerant. If the refrigerant is leaked, together with an external ignition source, there is a possibility of ignition.
 CAUTION	This symbol shows that the Operation Manual should be read carefully.
 CAUTION	This symbol shows that a service personnel should be handling this equipment with reference to the Installation Manual.
 CAUTION	This symbol shows that there is information included in the Operation Manual and/or Installation Manual.





- Carry out test run to confirm that no abnormality occurs after the servicing. Then, explain to user the operation, care and maintenance as stated in instructions. Please remind the customer to keep the operating instructions for future reference.

 WARNING		
1.	Do not use means to accelerate the defrosting process or to clean, other than those recommended by the manufacturer. Any unfit method or using incompatible material may cause product damage, burst and serious injury.	
2.	Do not install outdoor unit near handrail of veranda. When installing air-conditioner unit on veranda of a high rise building, child may climb up to outdoor unit and cross over the handrail causing an accident.	
3.	Do not use unspecified cord, modified cord, joint cord or extension cord for power supply cord. Do not share the single outlet with other electrical appliances. Poor contact, poor insulation or over current will cause electrical shock or fire.	
4.	The appliance shall be stored in a well ventilated room with floor area larger than A min (m ²) [refer Table A] and without any continuously operating ignition sources. Keep away from open flames, any operating gas appliances or any operating electric heater. Else, it may explode and cause injury or death.	
5.	Do not tie up the power supply cord into a bundle by band. Abnormal temperature rise on power supply cord may happen.	
6.	Do not insert your fingers or other objects into the unit, high speed rotating fan may cause injury.	
7.	Do not sit or step on the unit, you may fall down accidentally.	
8.	The appliance shall be installed, and/or operated in a room with floor area larger than A min (m ²) [refer Table A] and keep away from ignition sources, such as heat/sparks/open flame, or, hazardous areas, such as gas appliances, gas cooking, reticulated gas supply systems, or electric cooking appliances, etc.	
9.	Keep plastic bag (packaging material) away from small children, it may cling to nose and mouth and prevent breathing.	
10.	When installing or relocating air conditioner, do not let any substance other than the specified refrigerant, eg. air etc mix into refrigeration cycle (piping). Mixing of air etc. will cause abnormal high pressure in refrigeration cycle and result in explosion, injury etc.	
11.	Do not pierce or burn as the appliance is pressurized. Do not expose the appliance to heat, flame, sparks, or other sources of ignition. Else, it may explode and cause injury or death.	
12.	Do not add or replace refrigerant other than specified type. It may cause product damage, burst and injury etc.	



 **WARNING**

13.	Do not perform flare connection inside a building or dwelling or room, when joining the heat exchanger of indoor unit with interconnecting piping. Refrigerant connection inside a building or dwelling or room must be made by brazing or welding. Joint connection of indoor unit by flaring method can only be made at outdoor or at outside of a building or dwelling or room. Flare connection may cause gas leak and flammable atmosphere.	
14.	<ul style="list-style-type: none"> • For R32 model, use piping, flare nut and tools which is specified for R32 refrigerant. Using of existing (R22) piping, flare nut and tools may cause abnormally high pressure in the refrigerant cycle (piping), and possibly result in explosion and injury. • Thickness or copper pipes used with R32 must be more than 0.8 mm. Never use copper pipes thinner than 0.8 mm. • It is desirable that the amount of residual oil less than 40 mg/10 m. 	
15.	Engage authorized dealer or specialist for installation and servicing. If installation or servicing done by the user is defective, it will cause water leakage, electrical shock or fire.	
16.	For refrigeration system work, Install according to this installation instructions strictly. If installation is defective, it will cause water leakage, electrical shock or fire.	
17.	Use the attached accessories parts and specified parts for installation and servicing. Otherwise, it will cause the set to fall, water leakage, fire or electrical shock.	
18.	Install at a strong and firm location which is able to withstand weight of the set. If the strength is not enough or installation is not properly done, the set will drop and cause injury.	
19.	For electrical work, follow the national regulation, legislation and this installation instructions. An independent circuit and single outlet must be used. If electrical circuit capacity is not enough or defect found in the electrical work, it will cause electrical shock or fire.	
20.	Do not use joint cable for indoor/outdoor connection cable. Use the specified indoor/outdoor connection cable, refer to instruction CONNECT THE CABLE TO THE INDOOR UNIT and connect tightly for indoor/outdoor connection. Clamp the cable so that no external force will have impact on the terminal. If connection or fixing is not perfect, it will cause heat up or fire at the connection.	
21.	Wire routing must be properly arranged so that control board cover is fixed properly. If control board cover is not fixed perfectly, it will cause heat-up or fire at connection point of terminal, fire or electrical shock.	
22.	This equipment is strongly recommended to be installed with Earth Leakage Circuit Breaker (ELCB) or Residual Current Device (RCD), with sensitivity of 30mA at 0.1 sec or less. Otherwise, it may cause electrical shock and fire in case of equipment breakdown or insulation breakdown.	
23.	During installation, install the refrigerant piping properly before running the compressor. Operation of compressor without fixing refrigeration piping and valves at opened position will cause suck-in of air, abnormal high pressure in refrigeration cycle and result in explosion, injury etc.	
24.	During pump down operation, stop the compressor before removing the refrigeration piping. Removal of refrigeration piping while compressor is operating and valves are opened will cause suck-in of air, abnormal high pressure in refrigeration cycle and result in explosion, injury etc.	
25.	Tighten the flare nut with torque wrench according to specified method. If the flare nut is over-tightened, after a long period, the flare may break and cause refrigerant gas leakage.	
26.	After completion of installation or service, confirm there is no leakage of refrigerant gas. It may generate toxic gas when the refrigerant contacts with fire.	
27.	Ventilate if there is refrigerant gas leakage during operation. It may cause toxic gas when the refrigerant contacts with fire.	
28.	Be aware that refrigerants may not contain an odour.	
29.	This equipment must be properly earthed. Earth line must not be connected to gas pipe, water pipe, earth of lightning rod and telephone. Otherwise, it may cause electrical shock in case of equipment breakdown or insulation breakdown.	
30.	Do not modify the machine, part, material during repairing service.	
31.	If wiring unit is supplied as repairing part, do not repair or connect the wire even only partial wire break. Exchange the whole wiring unit.	
32.	Do not wrench the fasten terminal. Pull it out or insert it straightly.	
33.	Must not use other parts except original parts describe in catalog and manual.	

 **CAUTION**

1.	Do not install the unit in a place where leakage of flammable gas may occur. In case gas leaks and accumulates at surrounding of the unit, it may cause fire.	
2.	Prevent liquid or vapor from entering sumps or sewers since vapor is heavier than air and may form suffocating atmospheres.	
3.	Do not release refrigerant during piping work for installation, servicing, reinstallation and during repairing a refrigerant parts. Take care of the liquid refrigerant, it may cause frostbite.	
4.	Do not install this appliance in a laundry room or other location where water may drip from the ceiling, etc.	

 **CAUTION**

5.	Do not touch the sharp aluminium fin, sharp parts may cause injury.	
6.	Carry out drainage piping as mentioned in installation instructions. If drainage is not perfect, water may enter the room and damage the furniture.	
7.	Select an installation location which is easy for maintenance. Incorrect installation, service or repair of this air conditioner may increase the risk of rupture and this may result in loss damage or injury and/or property.	
8.	Power supply connection to the room air conditioner. Use power supply cord $3 \times 1.5 \text{ mm}^2$ (1.0 ~ 1.5HP), $3 \times 2.5 \text{ mm}^2$ (2.0 ~ 2.25HP) type designation 60245 IEC 57 or heavier cord. Connect the power supply cord of the air conditioner to the mains using one of the following method. Power supply point should be in easily accessible place for power disconnection in case of emergency. In some countries, permanent connection of this air conditioner to the power supply is prohibited. 1) Power supply connection to the receptacle using power plug. Use an approved 15/16A (1.0 ~ 1.5HP), 16A (2.0 ~ 2.25HP) power plug with earth pin for the connection to the socket. 2) Power supply connection to a circuit breaker for the permanent connection. Use an approved 16A (1.0 ~ 2.25HP) circuit breaker for the permanent connection. It must be a double pole switch with a minimum 3.0 mm contact gap.	
9.	Installation or servicing work: It may need two people to carry out the installation or servicing work.	
10.	Pb free solder has a higher melting point than standard solder; typically the melting point is 50°F – 70°F (30°C – 40°C) higher. Please use a high temperature solder iron. In case of the soldering iron with temperature control, please set it to $700 \pm 20^\circ\text{F}$ ($370 \pm 10^\circ\text{C}$). Pb free solder will tend to splash when heated too high (about 1100°F / 600°C).	
11.	Do not touch the sharp aluminum fins or edges of metal parts. If you are required to handle sharp parts during installation or servicing, please wear hand glove. Sharp parts may cause injury.	
12.	Tighten the flare nut with torque wrench according to specified method. If the flare nut is over-tightened, after a long period, the flare may break and cause refrigerant gas leakage.	
13.	Do not touch outdoor unit air inlet and aluminium fin. It may cause injury.	

2. Precaution for Using R32 Refrigerant

- The basic installation work procedures are the same as conventional refrigerant (R410A, R22) models. However, pay careful attention to the following points:

 WARNING	
1.	<p>Since the working pressure is higher than that of refrigerant R22 models, some of the piping and installation and service tools are special. (See "2.1. Special tools for R32 (R410A)".)</p> <p>Especially, when replacing a refrigerant R22 model with a new refrigerant R32 model, always replace the conventional piping and flare nuts with the R32 and R410A piping and flare nuts on the outdoor unit side. For R32 and R410A, the same flare nut on the outdoor unit side and pipe can be used.</p>
2.	<p>Models that use refrigerant R32 and R410A have a different charging port thread diameter to prevent erroneous charging with refrigerant R22 and for safety. Therefore, check beforehand. [The charging port thread diameter for R32 and R410A is 12.7 mm (1/2 inch).]</p>
3.	<p>Be more careful than R22 so that foreign matter (oil, water, etc.) does not enter the piping. Also, when storing the piping, securely seal the opening by pinching, taping, etc. (Handling of R32 is similar to R410A.)</p>

 CAUTION	
1.	<p>Installation (Space)</p> <ul style="list-style-type: none"> Must ensure the installation of pipe-work shall be kept to a minimum. Avoid use dented pipe and do not allow acute bending. Must ensure that pipe-work shall be protected from physical damage. Must comply with national gas regulations, state municipal rules and legislation. Notify relevant authorities in accordance with all applicable regulations. <ul style="list-style-type: none"> Must ensure mechanical connections be accessible for maintenance purposes. In cases that require mechanical ventilation, ventilation openings shall be kept clear of obstruction. When disposal of the product, do follow to the precautions in #12 and comply with national regulations. Always contact to local municipal offices for proper handling. Interconnecting refrigerant pipework, i.e. pipework external to the unitary components, should be marked with a Class label (see Figure 9.1 of Code of Practice) every two metres where the pipework is visible. This includes pipework located in a ceiling space or any void which a person may access for maintenance or repair work within that space.
2.	<p>Servicing</p> <p>2-1. Service personnel</p> <ul style="list-style-type: none"> Any qualified person who is involved with working on or breaking into a refrigerant circuit should hold a current valid certificate from an industry-accredited assessment authority, which authorizes their competence to handle refrigerants safely in accordance with an industry recognised assessment specification. Servicing shall only be performed as recommended by the equipment manufacturer. Maintenance and repair requiring the assistance of other skilled personnel shall be carried out under the supervision of the person competent in the use of flammable refrigerants. Servicing shall be performed only as recommended by the manufacturer. <p>2-2. Work</p> <ul style="list-style-type: none"> Prior to beginning work on systems containing flammable refrigerants, safety checks are necessary to ensure that the risk of ignition is minimised. For repair to the refrigerating system, the precautions in #2-2 to #2-8 must be followed before conducting work on the system. Work shall be undertaken under a controlled procedure so as to minimize the risk of a flammable gas or vapor being present while the work is being performed. All maintenance staff and others working in the local area shall be instructed and supervised on the nature of work being carried out. Avoid working in confined spaces. Wear appropriate protective equipment, including respiratory protection, as conditions warrant. Ensure that the conditions within the area have been made safe by limit of use of any flammable material. Keep all sources of ignition and hot metal surfaces away. <p>2-3. Checking for presence of refrigerant</p> <ul style="list-style-type: none"> The area shall be checked with an appropriate refrigerant detector prior to and during work, to ensure the technician is aware of potentially flammable atmospheres. Ensure that the leak detection equipment being used is suitable for use with flammable refrigerants, i.e. non sparking, adequately sealed or intrinsically safe. In case of leakage/spillage happened, immediately ventilate area and stay upwind and away from spill/release. In case of leakage/spillage happened, do notify persons downwind of the leaking/spill, isolate immediate hazard area and keep unauthorized personnel out. <p>2-4. Presence of fire extinguisher</p> <ul style="list-style-type: none"> If any hot work is to be conducted on the refrigeration equipment or any associated parts, appropriate fire extinguishing equipment shall be available at hand. Have a dry powder or CO₂ fire extinguisher adjacent to the charging area.

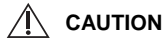
**CAUTION****2-5. No ignition sources**

- No person carrying out work in relation to a refrigeration system which involves exposing any pipe work that contains or has contained flammable refrigerant shall use any sources of ignition in such a manner that it may lead to the risk of fire or explosion. He/She must not be smoking when carrying out such work.
- All possible ignition sources, including cigarette smoking, should be kept sufficiently far away from the site of installation, repairing, removing and disposal, during which flammable refrigerant can possibly be released to the surrounding space.
- Prior to work taking place, the area around the equipment is to be surveyed to make sure that there are no flammable hazards or ignition risks.
- "No Smoking" signs shall be displayed.

2-6. Ventilated area

- Ensure that the area is in the open or that it is adequately ventilated before breaking into the system or conducting any hot work.
- A degree of ventilation shall continue during the period that the work is carried out.
- The ventilation should safely disperse any released refrigerant and preferably expel it externally into the atmosphere.

2-7. Checks to the refrigeration equipment

- Where electrical components are being changed, they shall be fit for the purpose and to the correct specification.
- At all times the manufacturer's maintenance and service guidelines shall be followed.
- If in doubt consult the manufacturer's technical department for assistance.
- The following checks shall be applied to installations using flammable refrigerants.
 - The charge size is in accordance with the room size within which the refrigerant containing parts are installed.
 - The ventilation machinery and outlets are operating adequately and are not obstructed.
 - If an indirect refrigerating circuit is being used, the secondary circuit shall be checked for the presence of refrigerant.
 - Marking to the equipment continues to be visible and legible. Markings and signs that are illegible shall be corrected.
 - Refrigeration pipe or components are installed in a position where they are unlikely to be exposed to any substance which may corrode refrigerant containing components, unless the components are constructed of materials which are inherently resistant to being corroded or are properly protected against being so corroded.

2-8. Checks to electrical devices

- Repair and maintenance to electrical components shall include initial safety checks and component inspection procedures.
- Initial safety checks shall include but not limit to:-
 - That capacitors are discharged: this shall be done in a safe manner to avoid possibility of sparking.
 - That there is no live electrical components and wiring are exposed while charging, recovering or purging the system.
 - That there is continuity of earth bonding.
- At all times the manufacturer's maintenance and service guidelines shall be followed.
- If in doubt consult the manufacturer's technical department for assistance.
- If a fault exists that could compromise safety, then no electrical supply shall be connected to the circuit until it is satisfactorily dealt with.
- If the fault cannot be corrected immediately but it is necessary to continue operation, an adequate temporary solution shall be used.
- The owner of the equipment must be informed or reported so all parties are advised thereafter.

Repairs to sealed components

- During repairs to sealed components, all electrical supplies shall be disconnected from the equipment being worked upon prior to any removal of sealed covers, etc.
 - If it is absolutely necessary to have an electrical supply to equipment during servicing, then a permanently operating form of leak detection shall be located at the most critical point to warn of a potentially hazardous situation.
 - Particular attention shall be paid to the following to ensure that by working on electrical components, the casing is not altered in such a way that the level of protection is affected. This shall include damage to cables, excessive number of connections, terminals not made to original specification, damage to seals, incorrect fitting of glands, etc.
- 3.
- Ensure that apparatus is mounted securely.
 - Ensure that seals or sealing materials have not degraded such that they no longer serve the purpose of preventing the ingress of flammable atmospheres.
 - Replacement parts shall be in accordance with the manufacturer's specifications.

NOTE: The use of silicon sealant may inhibit the effectiveness of some types of leak detection equipment. Intrinsically safe components do not have to be isolated prior to working on them.

Repair to intrinsically safe components

- Do not apply any permanent inductive or capacitance loads to the circuit without ensuring that this will not exceed the permissible voltage and current permitted for the equipment in use.
- 4.
- Intrinsically safe components are the only types that can be worked on while live in the presence of a flammable atmosphere.
 - The test apparatus shall be at the correct rating.
 - Replace components only with parts specified by the manufacturer. Unspecified parts by manufacturer may result ignition of refrigerant in the atmosphere from a leak.

Cabling

- 5.
- Check that cabling will not be subject to wear, corrosion, excessive pressure, vibration, sharp edges or any other adverse environmental effects.
 - The check shall also take into account the effects of aging or continual vibration from sources such as compressors or fans.

Detection of flammable refrigerants

- 6.
- Under no circumstances shall potential sources of ignition be used in the searching or detection of refrigerant leaks.
 - A halide torch (or any other detector using a naked flame) shall not be used.

 **CAUTION**

Leak detection methods

- Electronic leak detectors shall be used to detect flammable refrigerants, but the sensitivity may not be adequate, or may need re-calibration.
(Detection equipment shall be calibrated in a refrigerant-free area.)
 - Ensure that the detector is not a potential source of ignition and is suitable for the refrigerant used.
 - Leak detection equipment shall be set at a percentage of the LFL of the refrigerant and shall be calibrated to the refrigerant employed and the appropriate percentage of gas (25 % maximum) is confirmed.
- 7.
- Leak detection fluids are suitable for use with most refrigerants but the use of detergents containing chlorine shall be avoided as the chlorine may react with the refrigerant and corrode the copper pipe-work.
 - If a leak is suspected, all naked flames shall be removed/extinguished.
 - If a leakage of refrigerant is found which requires brazing, all of the refrigerant shall be recovered from the system, or isolated (by means of shut off valves) in a part of the system remote from the leak. Oxygen free nitrogen (OFN) shall then be purged through the system both before and during the brazing process.

Removal and evacuation

- When breaking into the refrigerant circuit to make repairs – or for any other purpose – conventional procedures shall be used. However, it is important that best practice is followed since flammability is a consideration. The following procedure shall be adhered to:

- remove refrigerant -> • purge the circuit with inert gas -> • evacuate -> • purge again with inert gas ->
- open the circuit by cutting or brazing

- 8.
- The refrigerant charge shall be recovered into the correct recovery cylinders.
 - The system shall be “flushed” with OFN to render the unit safe.
 - This process may need to be repeated several times.
 - Compressed air or oxygen shall not be used for this task.
 - Flushing shall be achieved by breaking the vacuum in the system with OFN and continuing to fill until the working pressure is achieved, then venting to atmosphere, and finally pulling down to a vacuum.
 - This process shall be repeated until no refrigerant is within the system.
 - When the final OFN charge is used, the system shall be vented down to atmospheric pressure to enable work to take place.
 - This operation is absolutely vital if brazing operations on the pipe work are to take place.
 - Ensure that the outlet for the vacuum pump is not close to any ignition sources and there is ventilation available.

Charging procedures

- In addition to conventional charging procedures, the following requirements shall be followed.
 - Ensure that contamination of different refrigerants does not occur when using charging equipment.
 - Hoses or lines shall be as short as possible to minimize the amount of refrigerant contained in them.
 - Cylinders shall be kept upright.
 - Ensure that the refrigeration system is earthed prior to charging the system with refrigerant.
 - Label the system when charging is complete (if not already).
 - Extreme care shall be taken not to over fill the refrigeration system.
- 9.
- Prior to recharging the system it shall be pressure tested with OFN (refer to #7).
 - The system shall be leak tested on completion of charging but prior to commissioning.
 - A follow up leak test shall be carried out prior to leaving the site.
 - Electrostatic charge may accumulate and create a hazardous condition when charging and discharging the refrigerant. To avoid fire or explosion, dissipate static electricity during transfer by grounding and bonding containers and equipment before charging/discharging.

Decommissioning

- Before carrying out this procedure, it is essential that the technician is completely familiar with the equipment and all its details.
- It is recommended good practice that all refrigerants are recovered safely.
- Prior to the task being carried out, an oil and refrigerant sample shall be taken in case analysis is required prior to re-use of reclaimed refrigerant.
- It is essential that electrical power is available before the task is commenced.
 - a) Become familiar with the equipment and its operation.
 - b) Isolate system electrically.
 - c) Before attempting the procedure ensure that:

- mechanical handling equipment is available, if required, for handling refrigerant cylinders;
- all personal protective equipment is available and being used correctly;
- the recovery process is supervised at all times by a competent person;
- recovery equipment and cylinders conform to the appropriate standards.

- 10.
- d) Pump down refrigerant system, if possible.
 - e) If a vacuum is not possible, make a manifold so that refrigerant can be removed from various parts of the system.
 - f) Make sure that cylinder is situated on the scales before recovery takes place.
 - g) Start the recovery machine and operate in accordance with manufacturer’s instructions.
 - h) Do not over fill cylinders. (No more than 80 % volume liquid charge).
 - i) Do not exceed the maximum working pressure of the cylinder, even temporarily.
 - j) When the cylinders have been filled correctly and the process completed, make sure that the cylinders and the equipment are removed from site promptly and all isolation valves on the equipment are closed off.
 - k) Recovered refrigerant shall not be charged into another refrigeration system unless it has been cleaned and checked.
- Electrostatic charge may accumulate and create a hazardous condition when charging or discharging the refrigerant. To avoid fire or explosion, dissipate static electricity during transfer by grounding and bonding containers and equipment before charging/discharging.

 CAUTION

Labelling

- 11.
- Equipment shall be labelled stating that it has been de-commissioned and emptied of refrigerant.
 - The label shall be dated and signed.
 - Ensure that there are labels on the equipment stating the equipment contains flammable refrigerant.

Recovery

- 12.
- When removing refrigerant from a system, either for servicing or decommissioning, it is recommended good practice that all refrigerants are removed safely.
 - When transferring refrigerant into cylinders, ensure that only appropriate refrigerant recovery cylinders are employed.
 - Ensure that the correct number of cylinders for holding the total system charge are available.
 - All cylinders to be used are designated for the recovered refrigerant and labelled for that refrigerant (i.e. special cylinders for the recovery of refrigerant).
 - Cylinders shall be complete with pressure relief valve and associated shut-off valves in good working order.
 - Recovery cylinders are evacuated and, if possible, cooled before recovery occurs.
 - The recovery equipment shall be in good working order with a set of instructions concerning the equipment that is at hand and shall be suitable for the recovery of flammable refrigerants.
 - In addition, a set of calibrated weighing scales shall be available and in good working order.
 - Hoses shall be complete with leak-free disconnect couplings and in good condition.
 - Before using the recovery machine, check that it is in satisfactory working order, has been properly maintained and that any associated electrical components are sealed to prevent ignition in the event of a refrigerant release. Consult manufacturer if in doubt.
 - The recovered refrigerant shall be returned to the refrigerant supplier in the correct recovery cylinder, and the relevant Waste Transfer Note arranged.
 - Do not mix refrigerants in recovery units and especially not in cylinders.
 - If compressors or compressor oils are to be removed, ensure that they have been evacuated to an acceptable level to make certain that flammable refrigerant does not remain within the lubricant.
 - The evacuation process shall be carried out prior to returning the compressor to the suppliers.
 - Only electric heating to the compressor body shall be employed to accelerate this process.
 - When oil is drained from a system, it shall be carried out safely.

3. Specifications

Model		Indoor	CS-Z25UB4EAW			CS-Z35UB4EAW				
		Outdoor	CU-Z25UBEA			CU-Z35UBEA				
Performance Test Condition			EUROVENT			EUROVENT				
Power Supply		Phase, Hz	Single, 50			Single, 50				
		V	230			230				
			Min.	Mid.	Max.	Min.	Mid.	Max.		
Cooling	Capacity		kW	0.85	2.50	3.20	0.85	3.50	4.00	
			BTU/h	2900	8530	10900	2900	11900	13600	
			Kcal/h	730	2150	2750	730	3010	3440	
	Running Current		A	–	2.50	–	–	4.10	–	
	Input Power		W	240	550	820	240	900	1.18k	
	Annual Consumption		kWh	–	275	–	–	450	–	
	EER		W/W	3.54	4.55	3.90	3.54	3.89	3.39	
			BTU/hW	12.08	15.51	13.29	12.08	13.22	11.53	
			Kcal/hW	3.04	3.91	3.35	3.04	3.34	2.92	
	ErP	Pdesign		kW	2.5			3.5		
		SEER		(W/W)	6.3			6.5		
		Annual Consumption		kWh	139			188		
		Class			A++			A++		
	Power Factor		%	–	96	–	–	95	–	
	Indoor Noise (H / L / QLo)		dB-A	34 / 25 / 22			34 / 26 / 23			
			Power Level dB	50 / –			50 / –			
	Outdoor Noise (H / L)		dB-A	46 / –			48 / –			
			Power Level dB	61 / –			63 / –			
Heating	Capacity		kW	0.85	3.20	4.80	0.85	4.50	5.60	
			BTU/h	2900	10900	16400	2900	15300	19100	
			Kcal/h	730	2750	4130	730	3870	4820	
	Running Current		A	–	3.60	–	–	6.00	–	
	Input Power		W	230	790	1.32k	230	1.36k	1.75k	
	COP		W/W	3.70	4.05	3.64	3.70	3.31	3.20	
			BTU/hW	12.61	13.80	12.42	12.61	11.25	10.91	
			Kcal/hW	3.17	3.48	3.13	3.17	2.85	2.75	
	ErP	Pdesign		kW	2.7			3.0		
		Tbivalent		°C	-10			-10		
		SCOP		(W/W)	4.3			4.2		
		Annual Consumption		kWh	879			1000		
		Class			A+			A+		
	Power Factor		%	–	95	–	–	99	–	
	Indoor Noise (H / L / QLo)		dB-A	35 / 28 / 25			35 / 28 / 25			
			Power Level dB	51 / –			51 / –			
	Outdoor Noise (H / L)		dB-A	47 / –			48 / –			
			Power Level dB	62 / –			63 / –			
Low Temp. : Capacity (kW) / I.Power (W) / COP			3.48 / 1.17k / 2.97			4.06 / 1.55k / 2.62				
Extr Low Temp. : Capacity (kW) / I.Power (W) / COP			2.88 / 1.19k / 2.42			3.37 / 1.60k / 2.11				
Max Current (A) / Max Input Power (W)			6.2 / 1.32k			8.0 / 1.75k				
Starting Current (A)			3.60			6.00				

Model		Indoor		CS-Z25UB4EAW		CS-Z35UB4EAW		
		Outdoor		CU-Z25UBEA		CU-Z35UBEA		
Compressor	Type			Hermetic Motor (Rotary)		Hermetic Motor (Rotary)		
	Motor Type			Brushless (6 poles)		Brushless (6 poles)		
	Output Power		W	700		700		
Indoor Fan	Type			BACKWARD FAN		BACKWARD FAN		
	Material			ABS		ABS		
	Motor Type			DC / Transistor (8-poles)		DC / Transistor (8-poles)		
	Input Power		W	-		-		
	Output Power		W	40		40		
	Speed	QLo	Cool	rpm	310		330	
			Heat	rpm	410		410	
		Lo	Cool	rpm	350		370	
			Heat	rpm	440		440	
		Me	Cool	rpm	450		460	
			Heat	rpm	510		510	
		Hi	Cool	rpm	560		560	
			Heat	rpm	580		580	
	SHi	Cool	rpm	600		600		
		Heat	rpm	630		630		
Outdoor Fan	Type			Propeller Fan		Propeller Fan		
	Material			PP		PP		
	Motor Type			DC (8-poles)		DC (8-poles)		
	Input Power		W	-		-		
	Output Power		W	40		40		
	Speed	Hi	Cool	rpm	820		850	
			Heat	rpm	780		830	
Moisture Removal			L/h (Pt/h)	1.5 (3.2)		2.0 (4.2)		
Indoor Airflow	QLo	Cool	m ³ /min (ft ³ /min.)	6.30 (222)		6.70 (237)		
		Heat	m ³ /min (ft ³ /min.)	8.00 (283)		8.00 (283)		
	Lo	Cool	m ³ /min (ft ³ /min.)	7.00 (247)		7.30 (258)		
		Heat	m ³ /min (ft ³ /min.)	8.50 (300)		8.50 (300)		
	Me	Cool	m ³ /min (ft ³ /min.)	8.70 (307)		8.80 (311)		
		Heat	m ³ /min (ft ³ /min.)	9.70 (343)		9.70 (343)		
	Hi	Cool	m ³ /min (ft ³ /min.)	10.50 (370)		10.50 (370)		
		Heat	m ³ /min (ft ³ /min.)	10.80 (380)		10.80 (380)		
	SHi	Cool	m ³ /min (ft ³ /min.)	11.20 (396)		11.20 (396)		
		Heat	m ³ /min (ft ³ /min.)	11.70 (413)		11.70 (413)		
Outdoor Airflow	Hi	Cool	m ³ /min (ft ³ /min.)	28.7 (1015)		34.3 (1210)		
		Heat	m ³ /min (ft ³ /min.)	27.2 (960)		33.5 (1185)		
Refrigeration Cycle	Control Device			Expansion Valve		Expansion Valve		
	Refrigerant Oil		cm ³	FW50S (320)		FW50S (320)		
	Refrigerant Type		g (oz)	R32, 880 (31.1)		R32, 930 (32.8)		
F-Gas	GWP			675		675		
	CO ₂ eq (ton) (Precharged Amount / Maximum Charged Amount)			0.594 / 0.678		0.628 / 0.712		
Dimension	Height (I/D / O/D / PANEL)		mm (inch)	260 (10-1/4) / 542 (21-11/32) / 51 (2-1/32)		260 (10-1/4) / 619 (24-3/8) / 51 (2-1/32)		
	Width (I/D / O/D / PANEL)		mm (inch)	575 (22-21/32) / 780 (30-23/32) / 700 (27-9/16)		575 (22-21/32) / 824 (32-15/32) / 700 (27-9/16)		
	Depth (I/D / O/D / PANEL)		mm (inch)	575 (22-21/32) / 289 (11-13/32) / 700 (27-9/16)		575 (22-21/32) / 299 (11-25/32) / 700 (27-9/16)		

Model		Indoor	CS-Z25UB4EAW		CS-Z35UB4EAW	
		Outdoor	CU-Z25UBEA		CU-Z35UBEA	
Weight	Net (I/D / O/D / PANEL)	kg (lb)	18 (40) / 33 (73) / 2.5 (6)		18 (40) / 35 (77) / 2.5 (6)	
Piping	Pipe Diameter (Liquid / Gas)	mm (inch)	6.35 (1/4) / 9.52 (3/8)		6.35 (1/4) / 9.52 (3/8)	
	Standard length	m (ft)	5.0 (16.4)		5.0 (16.4)	
	Length range (min – max)	m (ft)	3 (9.8) ~ 20 (65.6)		3 (9.8) ~ 20 (65.6)	
	I/D & O/D Height different	m (ft)	15.0 (49.2)		15.0 (49.2)	
	Additional Gas Amount	g/m (oz/ft)	10 (0.1)		10 (0.1)	
	Length for Additional Gas	m (ft)	7.5 (24.6)		7.5 (24.6)	
Drain Hose	Inner Diameter	mm	30		30	
	Length	mm	193		193	
Indoor Heat Exchanger	Fin Material		Aluminium (Pre Coat)		Aluminium (Pre Coat)	
	Fin Type		Slit Fin		Slit Fin	
	Row x Stage x FPI		2 x 10 x 18		2 x 10 x 18	
	Size (W x H x L)	mm	1330:1270 x 210 x 25.4		1330:1270 x 210 x 25.4	
Outdoor Heat Exchanger	Fin Material		Aluminium		Aluminium	
	Fin Type		Corrugated Fin		Corrugated Fin	
	Row x Stage x FPI		2 x 24 x 19		2 x 28 x 17	
	Size (W x H x L)	mm	36.4 x 504 x 824.2:793.7		36.38 x 588 x 856.3:827.7	
Air Filter	Material		-		-	
	Type		-		-	
Power Supply			Outdoor		Outdoor	
Power Supply Cord		A	Nil		Nil	
Thermostat			Electronic Contol		Electronic Contol	
Protection Device			Electronic Contol		Electronic Contol	
			Dry Bulb	Wet Bulb	Dry Bulb	Wet Bulb
Indoor Operation Range	Cooling	Maximum °C	32	23	32	23
		Minimum °C	16	11	16	11
	Heating	Maximum °C	30	-	30	-
		Minimum °C	16	-	16	-
Outdoor Operation Range	Cooling	Maximum °C	43	26	43	26
		Minimum °C	-10	-	-10	-
	Heating	Maximum °C	24	18	24	18
		Minimum °C	-15	-16	-15	-16

- Cooling capacities are based on indoor temperature of 27°C Dry Bulb (80.6°F Dry Bulb), 19.0°C Wet Bulb (66.2°F Wet Bulb) and outdoor air temperature of 35°C DRY BULB (95°F Dry Bulb), 24°C Wet Bulb (75.2°F Wet Bulb).
- Heating capacities are based on indoor temperature of 20°C Dry Bulb (68°F Dry Bulb) and outdoor air temperature of 7°C Dry Bulb (44.6°F Dry Bulb), 6°C Wet Bulb (42.8°F Wet Bulb).
- Heating low temperature capacity, Input Power and COP measured at 230 V, indoor temperature 20°C, outdoor 2/1°C.
- Heating extreme low temperature capacity, Input Power and COP measured at 230 V, indoor temperature 20°C, outdoor -7/-8°C.
- Standby power consumption ≤10.0w (when switched OFF by remote control, except under self protection control).
- Specifications are subjected to change without prior notice for further improvement.

Model		Indoor	CS-Z50UB4EAW			CS-Z60UB4EAW				
		Outdoor	CU-Z50UBEA			CU-Z60UBEA				
Performance Test Condition			EUROVENT			EUROVENT				
Power Supply		Phase, Hz	Single, 50			Single, 50				
		V	230			230				
			Min.	Mid.	Max.	Min.	Mid.	Max.		
Cooling	Capacity		kW	0.90	5.00	5.80	0.90	6.00	6.35	
			BTU/h	3070	17100	19800	3070	20500	21700	
			Kcal/h	770	4300	4990	770	5160	5460	
	Running Current		A	–	6.80	–	–	9.00	–	
	Input Power		W	255	1.54k	1.88k	255	2.05k	2.20k	
	Annual Consumption		kWh	–	770	–	–	1025	–	
	EER		W/W	3.53	3.25	3.09	3.53	2.93	2.89	
			BTU/hW	12.04	11.10	10.53	12.04	10.00	9.86	
			Kcal/hW	3.02	2.79	2.65	3.02	2.52	2.48	
	ErP	Pdesign		kW	5.0			6.0		
		SEER		(W/W)	6.4			6.2		
		Annual Consumption		kWh	273			339		
		Class			A++			A++		
	Power Factor		%	–	98	–	–	99	–	
	Indoor Noise (H / L / QLo)		dB-A	37 / 28 / 25			42 / 32 / 29			
			Power Level dB	53 / –			58 / –			
	Outdoor Noise (H / L)		dB-A	48 / –			49 / –			
			Power Level dB	63 / –			64 / –			
	Heating	Capacity		kW	0.90	5.60	7.10	0.90	7.00	8.00
				BTU/h	3070	19100	24200	3070	23900	27300
Kcal/h				770	4820	6110	770	6020	6880	
Running Current		A	–	8.20	–	–	10.50	–		
Input Power		W	260	1.85k	2.41k	260	2.40k	2.75k		
COP		W/W	3.46	3.03	2.95	3.46	2.92	2.91		
		BTU/hW	11.81	10.32	10.04	11.81	9.96	9.93		
		Kcal/hW	2.96	2.61	2.54	2.96	2.51	2.50		
ErP		Pdesign		kW	3.8			4.0		
		Tbivalent		°C	-10			-10		
		SCOP		(W/W)	4.3			4.2		
		Annual Consumption		kWh	1237			1333		
		Class			A+			A+		
Power Factor		%	–	98	–	–	99	–		
Indoor Noise (H / L / QLo)		dB-A	38 / 29 / 26			43 / 32 / 29				
		Power Level dB	54 / –			59 / –				
Outdoor Noise (H / L)		dB-A	48 / –			50 / –				
		Power Level dB	63 / –			65 / –				
Low Temp. : Capacity (kW) / I.Power (W) / COP			5.14 / 2.13k / 2.41			5.80 / 2.43k / 2.39				
Extr Low Temp. : Capacity (kW) / I.Power (W) / COP			4.40 / 2.25k / 1.96			5.10 / 2.45k / 2.08				
Max Current (A) / Max Input Power (W)			10.8 / 2.41k			12.4 / 2.75k				
Starting Current (A)			8.20			10.50				

Model			Indoor	CS-Z50UB4EAW	CS-Z60UB4EAW	
			Outdoor	CU-Z50UBEA	CU-Z60UBEA	
Compressor	Type			Hermetic Motor (Rotary)	Hermetic Motor (Rotary)	
	Motor Type			Brushless (4 poles)	Brushless (4 poles)	
	Output Power		W	900	900	
Indoor Fan	Type			BACKWARD FAN	BACKWARD FAN	
	Material			ABS	ABS	
	Motor Type			DC / Transistor (8-poles)	DC / Transistor (8-poles)	
	Input Power		W	–	–	
	Output Power		W	40	40	
	Speed	QLo	Cool	rpm	360	450
			Heat	rpm	430	450
		Lo	Cool	rpm	390	480
			Heat	rpm	450	510
		Me	Cool	rpm	500	590
			Heat	rpm	540	660
		Hi	Cool	rpm	620	700
			Heat	rpm	640	750
SHi	Cool	rpm	670	750		
	Heat	rpm	690	820		
Outdoor Fan	Type			Propeller Fan	Propeller Fan	
	Material			PP	PP	
	Motor Type			DC (8-poles)	DC (8-poles)	
	Input Power		W	–	–	
	Output Power		W	40	40	
	Speed	Hi	Cool	rpm	720	770
Heat			rpm	700	750	
Moisture Removal			L/h (Pt/h)	2.8 (5.9)	3.3 (7.0)	
Indoor Airflow	QLo	Cool	m ³ /min (ft ³ /min.)	7.20 (254)	7.50 (265)	
		Heat	m ³ /min (ft ³ /min.)	8.30 (293)	7.50 (265)	
	Lo	Cool	m ³ /min (ft ³ /min.)	7.70 (272)	8.10 (286)	
		Heat	m ³ /min (ft ³ /min.)	8.70 (307)	8.70 (307)	
	Me	Cool	m ³ /min (ft ³ /min.)	9.50 (335)	10.30 (364)	
		Heat	m ³ /min (ft ³ /min.)	10.20 (360)	11.70 (413)	
	Hi	Cool	m ³ /min (ft ³ /min.)	11.5 (405)	12.4 (440)	
		Heat	m ³ /min (ft ³ /min.)	11.8 (415)	13.5 (475)	
SHi	Cool	m ³ /min (ft ³ /min.)	12.30 (434)	13.40 (473)		
	Heat	m ³ /min (ft ³ /min.)	12.70 (448)	14.80 (523)		
Outdoor Airflow	Hi	Cool	m ³ /min (ft ³ /min.)	39.7 (1400)	42.6 (1505)	
		Heat	m ³ /min (ft ³ /min.)	38.6 (1365)	41.5 (1465)	
Refrigeration Cycle	Control Device			Expansion Valve	Expansion Valve	
	Refrigerant Oil		cm ³	FW50S (450)	FW50S (450)	
	Refrigerant Type		g (oz)	R32, 1.13k (39.9)	R32, 1.13k (39.9)	
F-Gas	GWP			675	675	
	CO2eq (ton) (Precharged Amount / Maximum Charged Amount)			0.763 / 0.991	0.763 / 0.991	
Dimension	Height (I/D / O/D / PANEL)		mm (inch)	260 (10-1/4) / 695 (27-3/8) / 51 (2-1/32)	260 (10-1/4) / 695 (27-3/8) / 51 (2-1/32)	
	Width (I/D / O/D / PANEL)		mm (inch)	575 (22-21/32) / 875 (34-15/32) / 700 (27-9/16)	575 (22-21/32) / 875 (34-15/32) / 700 (27-9/16)	
	Depth (I/D / O/D / PANEL)		mm (inch)	575 (22-21/32) / 320 (12-5/8) / 700 (27-9/16)	575 (22-21/32) / 320 (12-5/8) / 700 (27-9/16)	

Model		Indoor	CS-Z50UB4EAW		CS-Z60UB4EAW	
		Outdoor	CU-Z50UBEA		CU-Z60UBEA	
Weight	Net (I/D / O/D / PANEL)	kg (lb)	18 (40) / 43 (95) / 2.5 (6)		18 (40) / 43 (95) / 2.5 (6)	
Piping	Pipe Diameter (Liquid / Gas)	mm (inch)	6.35 (1/4) / 12.70 (1/2)		6.35 (1/4) / 12.70 (1/2)	
	Standard length	m (ft)	5.0 (16.4)		5.0 (16.4)	
	Length range (min – max)	m (ft)	3 (9.8) ~ 30 (98.4)		3 (9.8) ~ 30 (98.4)	
	I/D & O/D Height different	m (ft)	20.0 (65.6)		20.0 (65.6)	
	Additional Gas Amount	g/m (oz/ft)	15 (0.2)		15 (0.2)	
	Length for Additional Gas	m (ft)	7.5 (24.6)		7.5 (24.6)	
Drain Hose	Inner Diameter	mm	30		30	
	Length	mm	193		193	
Indoor Heat Exchanger	Fin Material		Aluminium (Pre Coat)		Aluminium (Pre Coat)	
	Fin Type		Slit Fin		Slit Fin	
	Row x Stage x FPI		2 x 10 x 18		2 x 10 x 20	
	Size (W x H x L)	mm	1330:1270 x 210 x 25.4		1330:1270 x 210 x 25.4	
Outdoor Heat Exchanger	Fin Material		Aluminium		Aluminium	
	Fin Type		Corrugated Fin (Pre Coat)		Corrugated Fin (Pre Coat)	
	Row x Stage x FPI		2 x 31 x 19		2 x 31 x 19	
	Size (W x H x L)	mm	36.4 x 651 x 854.5:824.5		36.4 x 651 x 854.5:824.5	
Air Filter	Material		-		-	
	Type		-		-	
Power Supply			Outdoor		Outdoor	
Power Supply Cord		A	Nil		Nil	
Thermostat			Electronic Control		Electronic Control	
Protection Device			Electronic Control		Electronic Control	
			Dry Bulb	Wet Bulb	Dry Bulb	Wet Bulb
Indoor Operation Range	Cooling	Maximum °C	32	23	32	23
		Minimum °C	16	11	16	11
	Heating	Maximum °C	30	-	30	-
		Minimum °C	16	-	16	-
Outdoor Operation Range	Cooling	Maximum °C	43	26	43	26
		Minimum °C	-10	-	-10	-
	Heating	Maximum °C	24	18	24	18
		Minimum °C	-15	-16	-15	-16

- Cooling capacities are based on indoor temperature of 27°C Dry Bulb (80.6°F Dry Bulb), 19.0°C Wet Bulb (66.2°F Wet Bulb) and outdoor air temperature of 35°C DRY BULB (95°F Dry Bulb), 24°C Wet Bulb (75.2°F Wet Bulb).
- Heating capacities are based on indoor temperature of 20°C Dry Bulb (68°F Dry Bulb) and outdoor air temperature of 7°C Dry Bulb (44.6°F Dry Bulb), 6°C Wet Bulb (42.8°F Wet Bulb).
- Heating low temperature capacity, Input Power and COP measured at 230 V, indoor temperature 20°C, outdoor 2/1°C.
- Heating extreme low temperature capacity, Input Power and COP measured at 230 V, indoor temperature 20°C, outdoor -7/-8°C.
- Standby power consumption ≤10.0w (when switched OFF by remote control, except under self protection control).
- Specifications are subjected to change without prior notice for further improvement.

- **Multi Split Combination Possibility:**

- A single outdoor unit enables air conditioning of up to two separate rooms for CU-2Z35TBE, CU-2Z41TBE, CU-2Z50TBE.
- A single outdoor unit enables air conditioning of up to three separate rooms for CU-3Z68TBE, CU-3Z52TBE.

CONNECTABLE INDOOR UNIT			CU-2Z35TBE		CU-2Z41TBE		CU-2Z50TBE		CU-3Z68TBE			CU-3Z52TBE		
ROOM			A	B	A	B	A	B	A	B	C	A	B	C
Wall	2.0kW	CS-MZ20UB4EA	●	●	●	●	●	●	●	●	●	●	●	●
	2.5kW	CS-Z25UB4EAW	●	●	●	●	●	●	●	●	●	●	●	●
	3.5kW	CS-Z35UB4EAW	●	–	●	–	●	●	●	●	●	●	●	–
	5.0kW	CS-Z50UB4EAW	–	–	–	–	●	–	●	●	–	●	–	–
	6.0kW	CS-Z60UB4EAW	–	–	–	–	–	–	●	–	–	–	–	–
Capacity range of connectable units			From 3.2kW to 6.0kW		From 3.2kW to 6.0kW		From 3.2kW to 7.7kW		From 4.5kW to 11.2kW			From 4.5kW to 9.5kW		
Pipe length	1 room maximum pipe length (m)		20		20		20		25			25		
	Allowable elevation (m)		10		10		10		15			15		
	Total allowable pipe length (m)		30		30		30		60			50		
	Total pipe length for maximum chargeless length (m)		20		20		20		30			30		
	Additional gas amount over chargeless length (g/m)		15		15		15		20			20		
Note: “●” : Available														
Remarks for CU-2Z35TBE / CU-2Z41TBE / CU-2Z50TBE														
1. The total nominal cooling capacity of indoor unit that will be connected to outdoor unit must be within connectable capacity range of indoor unit. (as shown in the table above) Example: The indoor units' combination below is possible to connect to CU-2Z41TBE. (Total nominal capacity of indoor units is between 3.2kW to 6.0kW) 1) Two CS-MZ20UB4EA only. (Total nominal cooling capacity is 4.0kW)														
Remarks for CU-3Z68TBE / CU-3Z52TBE														
1. The total nominal cooling capacity of indoor unit that will be connected to outdoor unit must be within connectable capacity range of indoor unit. (as shown in the table above) Example: The indoor units' combination below is possible to connect to CU-3Z68TBE. (Total nominal capacity of indoor units is between 4.5kW to 11.2kW) 1) Two CS-Z25UB4EAW only. (Total nominal cooling capacity is 5.0kW)														

- **Multi Split Combination Possibility:**

- A single outdoor unit enables air conditioning of up to four separate rooms for CU-4Z68TBE, CU-4Z80TBE.
- A single outdoor unit enables air conditioning of up to five separate rooms for CU-5Z90TBE.

CONNECTABLE INDOOR UNIT			CU-4Z68TBE				CU-4Z80TBE				CU-5Z90TBE				
ROOM			A	B	C	D	A	B	C	D	A	B	C	D	E
Wall	2.0kW	CS-MZ20UB4EA	•	•	•	•	•	•	•	•	•	•	•	•	•
	2.5kW	CS-Z25UB4EAW	•	•	•	•	•	•	•	•	•	•	•	•	•
	3.5kW	CS-Z35UB4EAW	•	•	•	–	•	•	•	•	•	•	•	•	•
	5.0kW	CS-Z50UB4EAW	•	•	–	–	•	•	–	–	•	•	•	–	–
	6.0kW	CS-Z60UB4EAW	•	–	–	–	•	•	–	–	•	•	–	–	–
Capacity range of connectable units			From 4.5kW to 11.5kW				From 4.5kW to 14.7kW				From 4.5kW to 18.3kW				
Pipe length	1 room maximum pipe length (m)		25				25				25				
	Allowable elevation (m)		15				15				15				
	Total allowable pipe length (m)		60				70				80				
	Total pipe length for maximum chargeless length (m)		30				45				45				
	Additional gas amount over chargeless length (g/m)		20				20				20				
Note: "•" : Available															
Remarks for CU-4Z68TBE / CU-4Z80TBE / CU-5Z90TBE															
1. The total nominal cooling capacity of indoor unit that will be connected to outdoor unit must be within connectable capacity range of indoor unit. (as shown in the table above) Example: The indoor units' combination below is possible to connect to CU-4Z80TBE. (Total nominal capacity of indoor units is between 4.5kW to 14.7kW) 1) Two CS-Z25UB4EAW only. (Total nominal cooling capacity is 5.0kW)															

• **Multi Split Combination Possibility:**

- A single outdoor unit enables air conditioning of up to two separate rooms for CU-2E12SBE, CU-2E15SBE, CU-2E18SBE.
- A single outdoor unit enables air conditioning of up to three separate rooms for CU-3E23SBE, CU-3E18PBE.

CONNECTABLE INDOOR UNIT			CU-2E12SBE*		CU-2E15SBE*		CU-2E18SBE*		CU-3E23SBE*			CU-3E18PBE*		
ROOM			A	B	A	B	A	B	A	B	C	A	B	C
Wall	2.0kW	CS-MZ20UB4EA	●	●	●	●	●	●	●	●	●	●	●	●
	2.5kW	CS-Z25UB4EAW	●	●	●	●	●	●	●	●	●	●	●	●
	3.2kW	CS-Z35UB4EAW	●	–	●	–	●	●	●	●	●	●	●	–
	5.0kW	CS-Z50UB4EAW	–	–	–	–	●	–	●	●	–	●	–	–
	6.0kW	CS-Z60UB4EAW	–	–	–	–	–	–	●	–	–	–	–	–
Capacity range of connectable units			From 3.2kW to 5.7kW		From 3.2kW to 5.7kW		From 3.2kW to 7.5kW		From 4.5kW to 11.0kW			From 4.5kW to 9.0kW		
Pipe length	1 room maximum pipe length (m)		20		20		20		25			25		
	Allowable elevation (m)		10		10		10		15			15		
	Total allowable pipe length (m)		30		30		30		60			50		
	Total pipe length for maximum chargeless length (m)		20		20		20		30			30		
	Additional gas amount over chargeless length (g/m)		15		15		15		20			20		
Note: “●” : Available														
Remarks for CU-2E12SBE / CU-2E15SBE / CU-2E18SBE														
1. The total nominal cooling capacity of indoor unit that will be connected to outdoor unit must be within connectable capacity range of indoor unit. (as shown in the table above) Example: The indoor units' combination below is possible to connect to CU-2E15SBE. (Total nominal capacity of indoor units is between 3.2kW to 5.7kW) 1) Two CS-MZ20UB4EA only. (Total nominal cooling capacity is 4.0kW)														
Remarks for CU-3E23SBE / CU-3E18PBE														
1. The total nominal cooling capacity of indoor unit that will be connected to outdoor unit must be within connectable capacity range of indoor unit. (as shown in the table above) Example: The indoor units' combination below is possible to connect to CU-3E23SBE. (Total nominal capacity of indoor units is between 4.5kW to 11.0kW) 1) Two CS-Z25UB4EAW only. (Total nominal cooling capacity is 5.0kW)														

Note*: Above outdoor unit is contains and operates with refrigerant R410A gas.

- **Multi Split Combination Possibility:**

- A single outdoor unit enables air conditioning of up to four separate rooms for CU-4E23PBE, CU-4E27PBE.
- A single outdoor unit enables air conditioning of up to five separate rooms for CU-5E34PBE.

CONNECTABLE INDOOR UNIT			CU-4E23PBE*				CU-4E27PBE*				CU-5E34PBE*				
ROOM			A	B	C	D	A	B	C	D	A	B	C	D	E
	2.0kW	CS-MZ20UB4EA	•	•	•	•	•	•	•	•	•	•	•	•	•
	2.5kW	CS-Z25UB4EAW	•	•	•	•	•	•	•	•	•	•	•	•	•
	3.2kW	CS-Z35UB4EAW	•	•	•	–	•	•	•	•	•	•	•	•	•
	5.0kW	CS-Z50UB4EAW	•	•	–	–	•	•	–	–	•	•	•	–	–
	6.0kW	CS-Z60UB4EAW	•	–	–	–	•	•	–	–	•	•	–	–	–
Capacity range of connectable units			From 4.5kW to 11.0kW				From 4.5kW to 13.6kW				From 4.5kW to 17.5kW				
Pipe length	1 room maximum pipe length (m)		25				25				25				
	Allowable elevation (m)		15				15				15				
	Total allowable pipe length (m)		60				70				80				
	Total pipe length for maximum chargeless length (m)		30				45				45				
	Additional gas amount over chargeless length (g/m)		20				20				20				
Note: "•" : Available															
Remarks for CU-4E23PBE / CU-4E27PBE / CU-5E34PBE															
1. The total nominal cooling capacity of indoor unit that will be connected to outdoor unit must be within connectable capacity range of indoor unit. (as shown in the table above) Example: The indoor units' combination below is possible to connect to CU-4E27PBE. (Total nominal capacity of indoor units is between 4.5kW to 13.6kW) 1) Two CS-Z25UB4EAW only. (Total nominal cooling capacity is 5.0kW)															

Note*: Above outdoor unit is contains and operates with refrigerant R410A gas.

4. Features

- **Inverter Technology**
 - Wider output power range
 - Energy saving
 - Quick Cooling
 - Quick Heating
 - More precise temperature control
- **Environment Protection**
 - Non-ozone depletion substances refrigerant (R32)
- **Long Installation Piping**
 - Long piping up to 20 meters (1.0 ~ 1.5HP) and 30 meters (2.0 ~ 2.25HP) during single split connection only
- **Easy to use remote control**
- **Quality Improvement**
 - Random auto restart after power failure for safety restart operation
 - Gas leakage protection
 - Prevent compressor reverse cycle
 - Inner protector to protect compressor
 - Noise prevention during soft dry operation
- **Operation Improvement**
 - Quiet mode to reduce the indoor unit operating sound
 - Powerful mode to reach the desired room temperature quickly
 - 24-hour timer setting
- **Serviceability Feature**
 - Breakdown Self Diagnosis function
 - Activation and Deactivation Method for Heating Only Mode

5. Location of Controls and Components

5.1 Indoor Unit

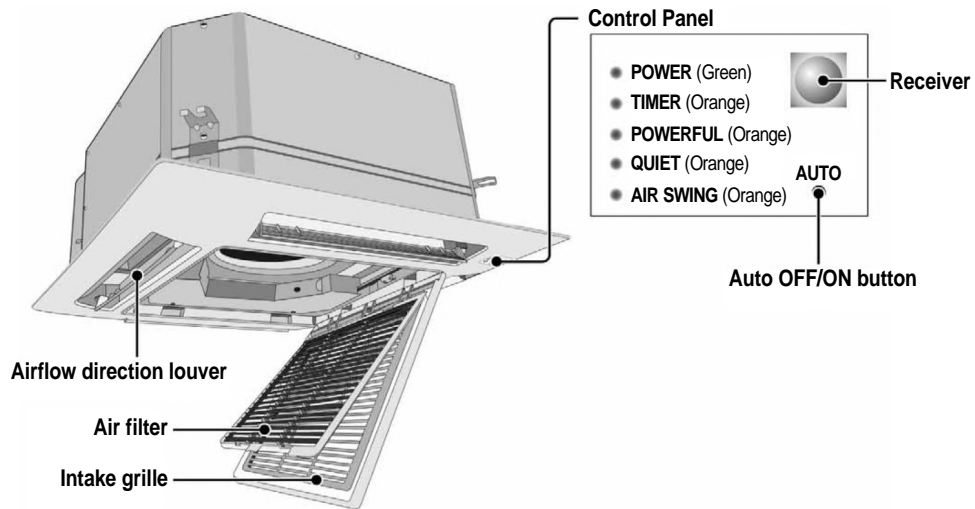

5.2 Outdoor Unit

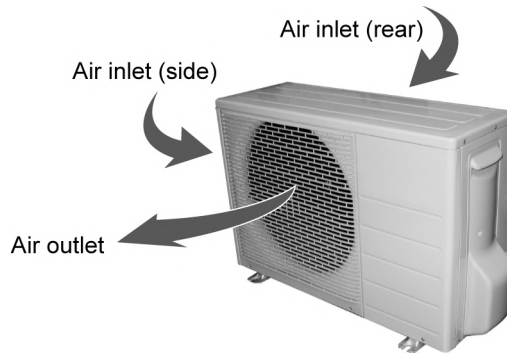

5.3 Remote Control



6. Dimensions

6.1 Indoor Unit

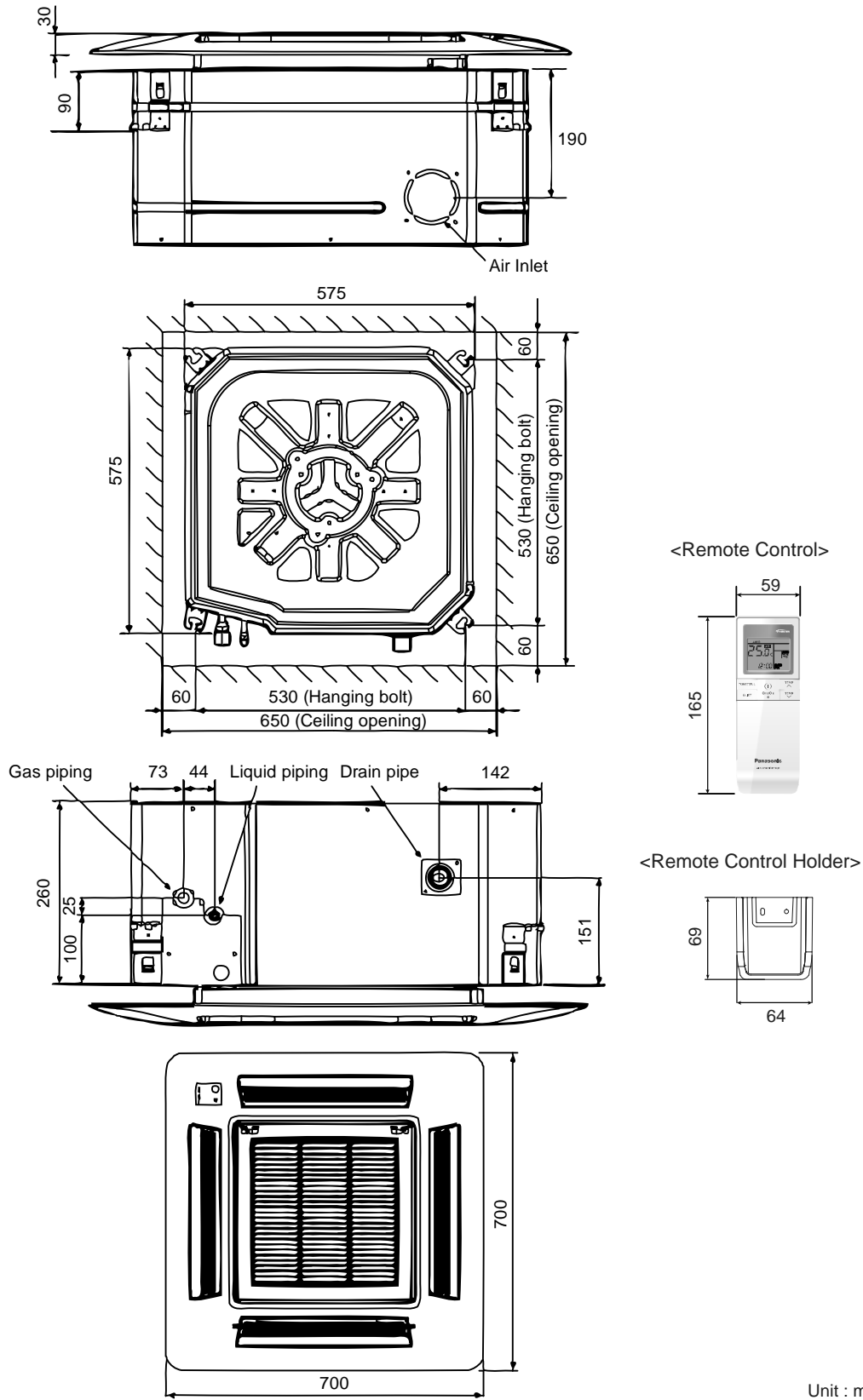

Unit : mm

6.2 Outdoor Unit

6.2.1 CU-Z25UBEA

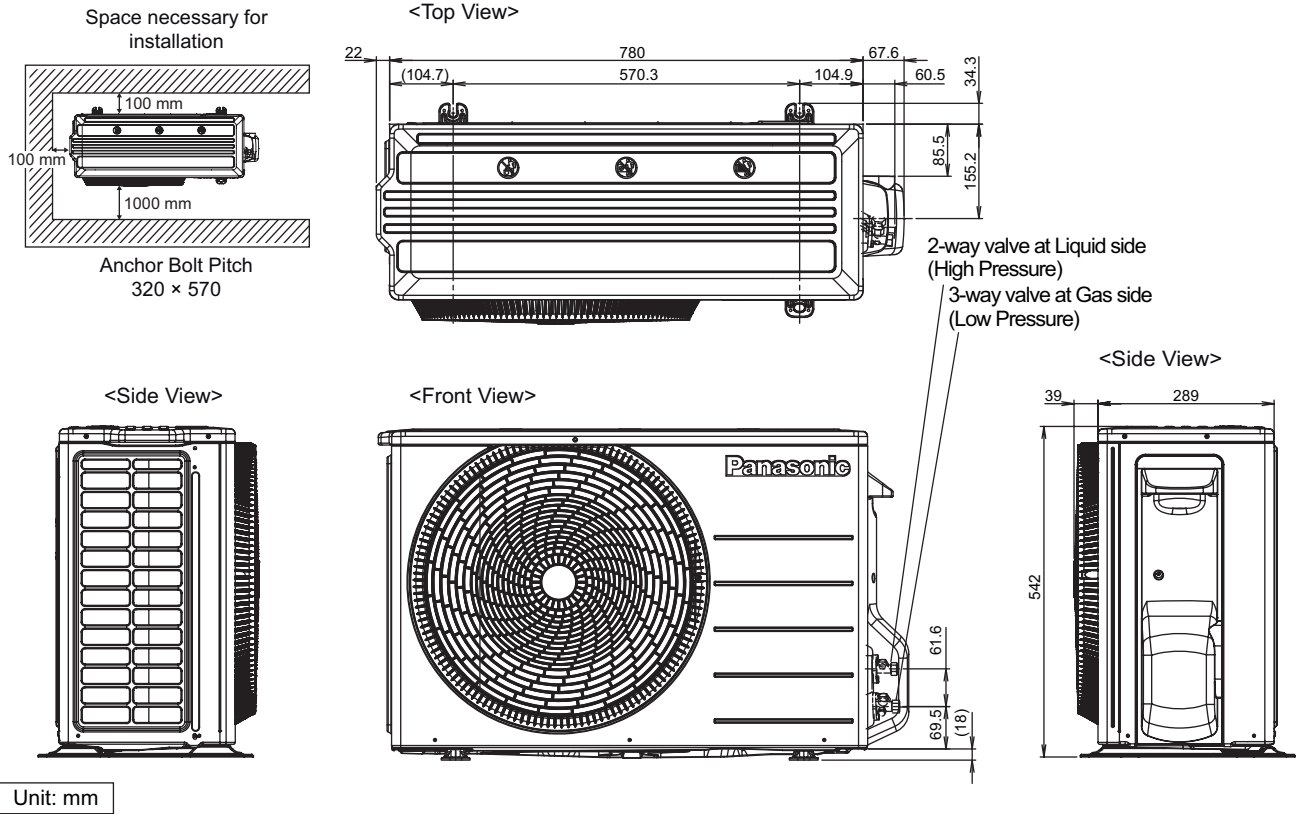

6.2.2 CU-Z35UBEA

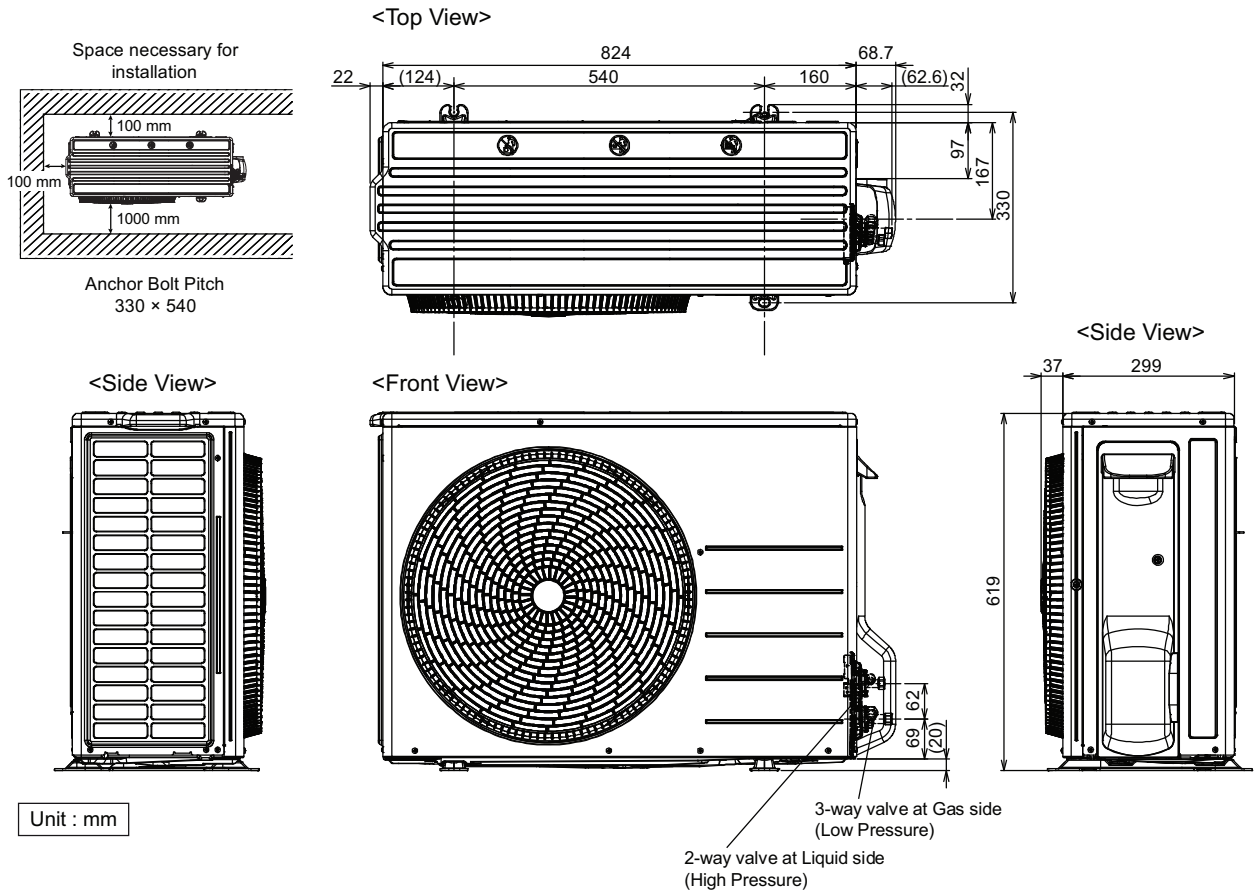

6.2.3 CU-Z50UBEA CU-Z60UBEA

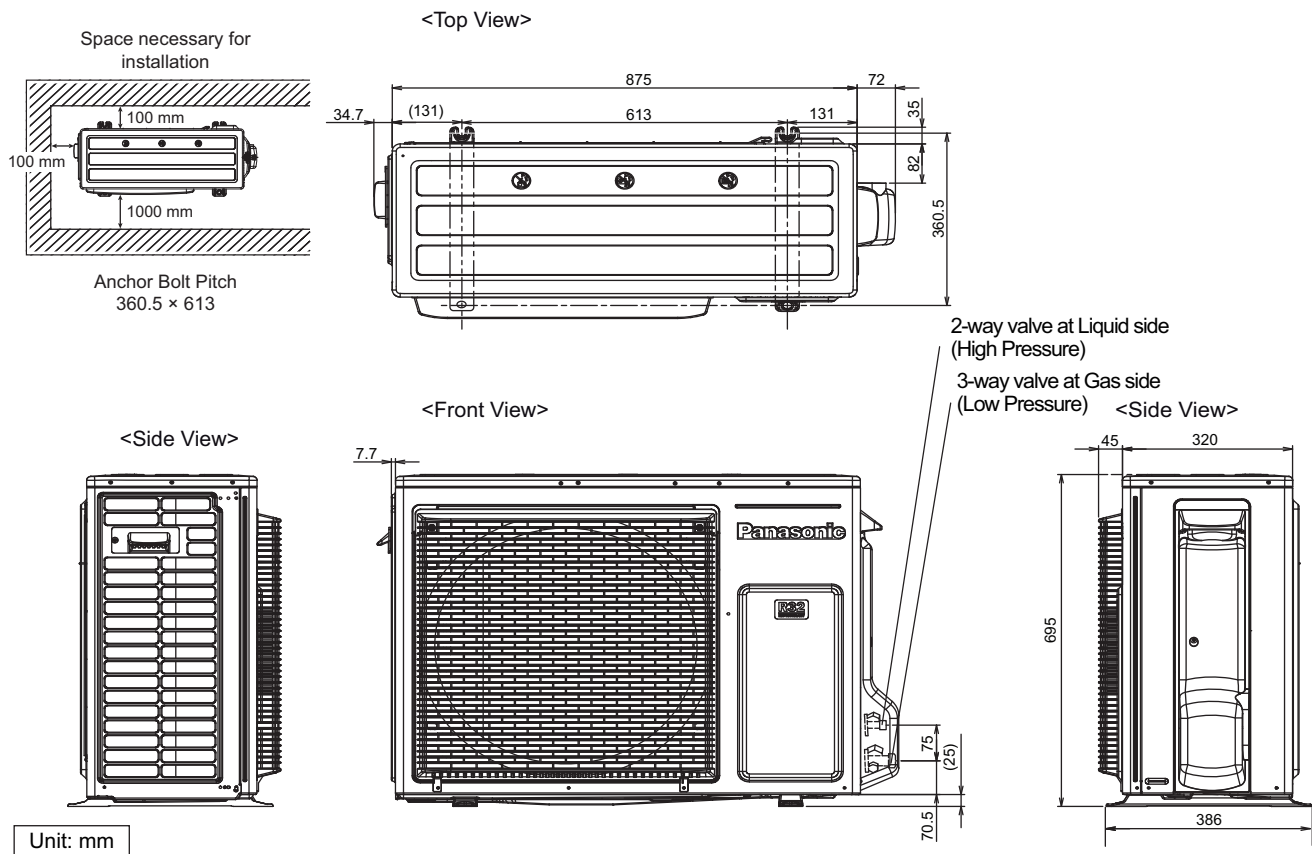

7. Refrigeration Cycle Diagram

7.1 CS-Z25UB4EAW CU-Z25UBEA CS-Z35UB4EAW CU-Z35UBEA

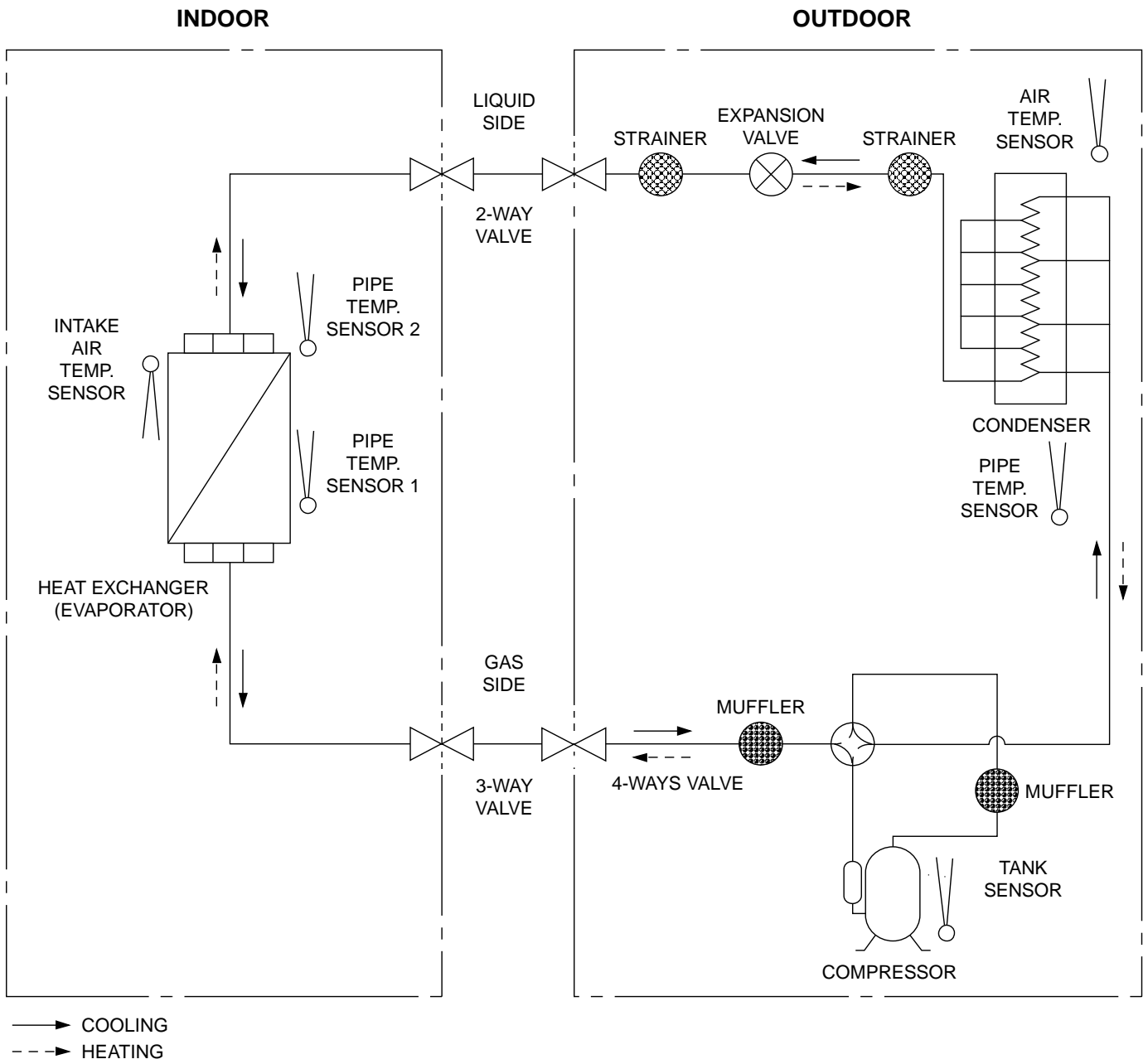

7.2 CS-Z50UB4EAW CU-Z50UBEA CS-Z60UB4EAW CU-Z60UBEA

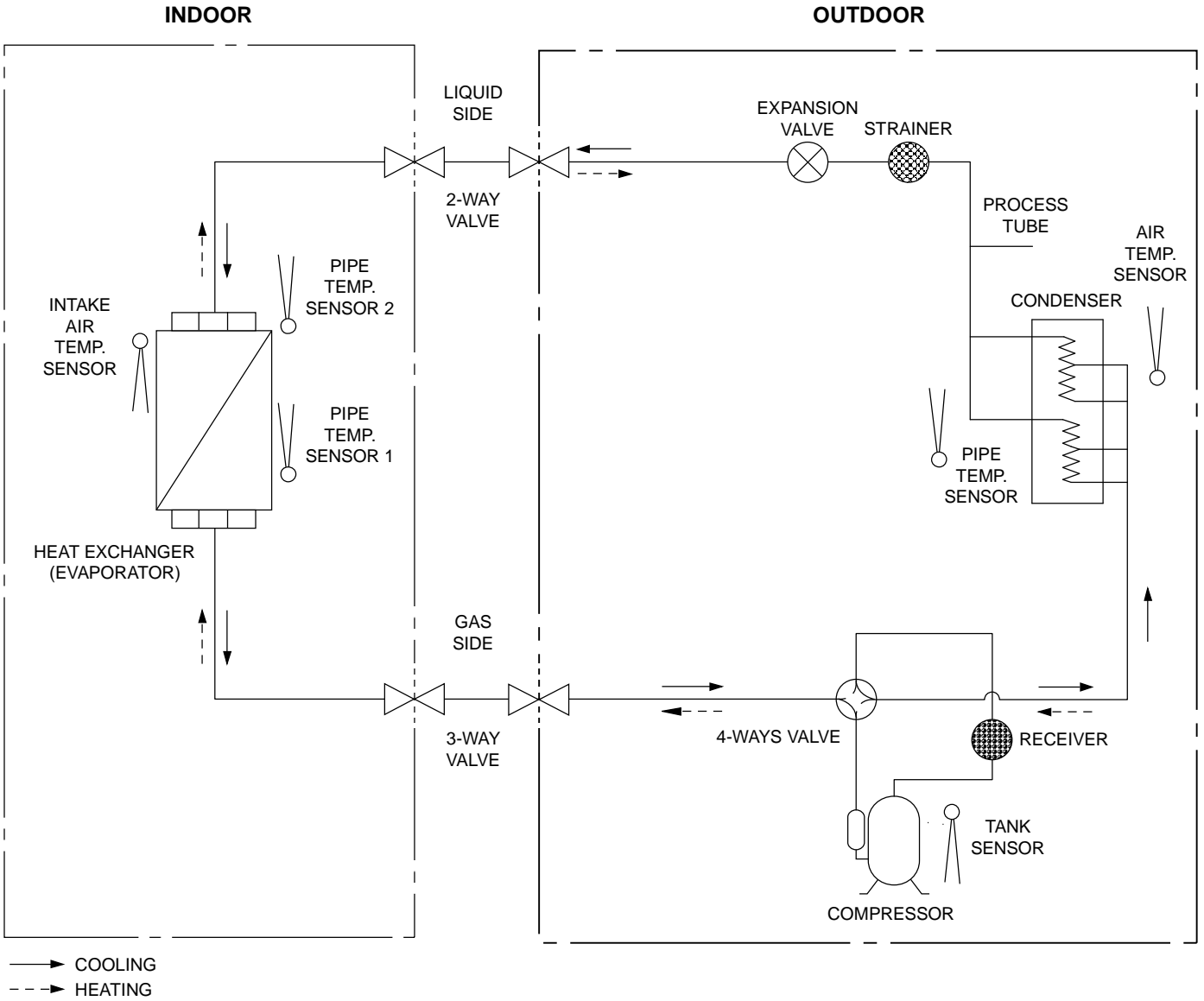

8. Block Diagram

8.1 CS-Z25UB4EAW CU-Z25UBEA CS-Z35UB4EAW CU-Z35UBEA

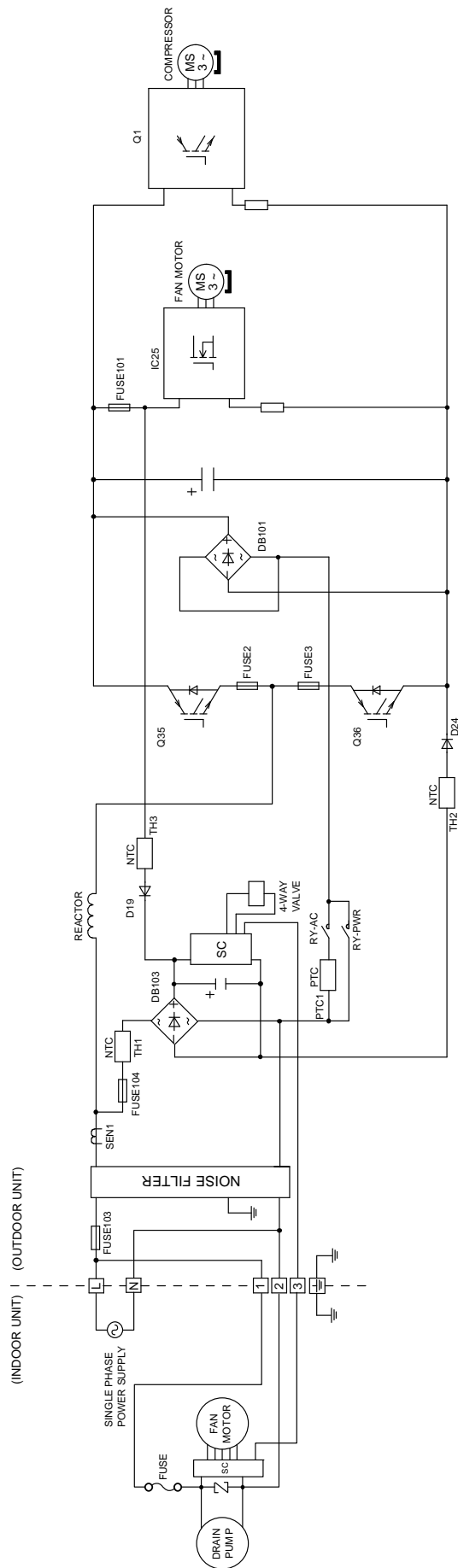

8.2 CS-Z50UB4EAW CU-Z50UBEA CS-Z60UB4EAW CU-Z60UBEA

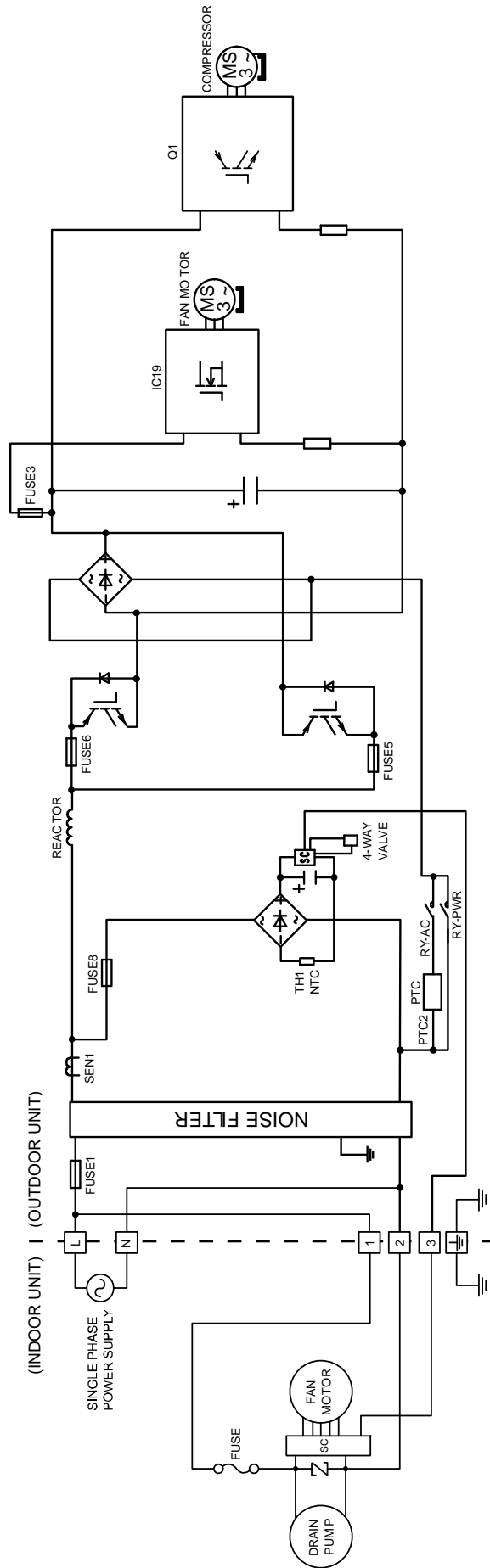

9. Wiring Connection Diagram

9.1 Indoor Unit

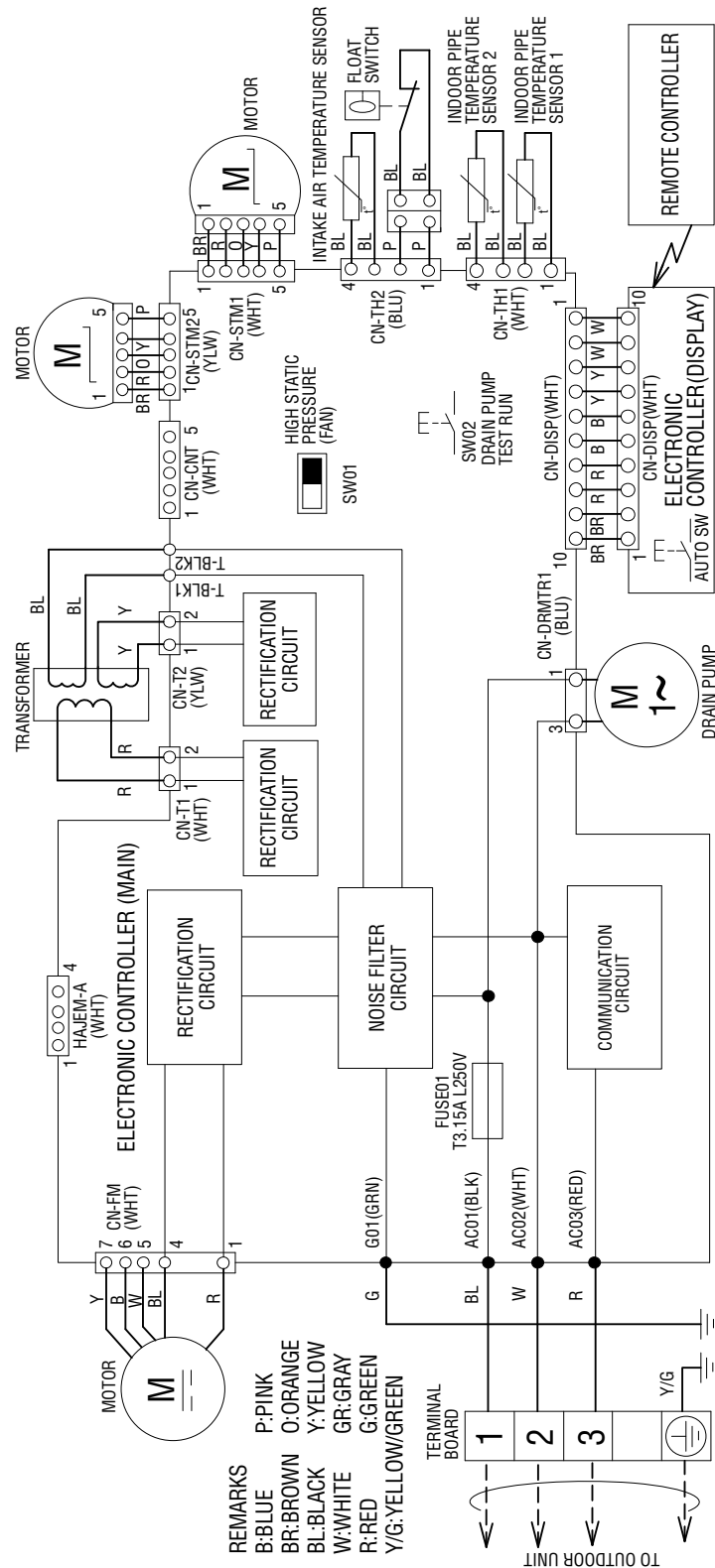

9.2 Outdoor Unit

9.2.1 CU-Z25UBEA CU-Z35UBEA

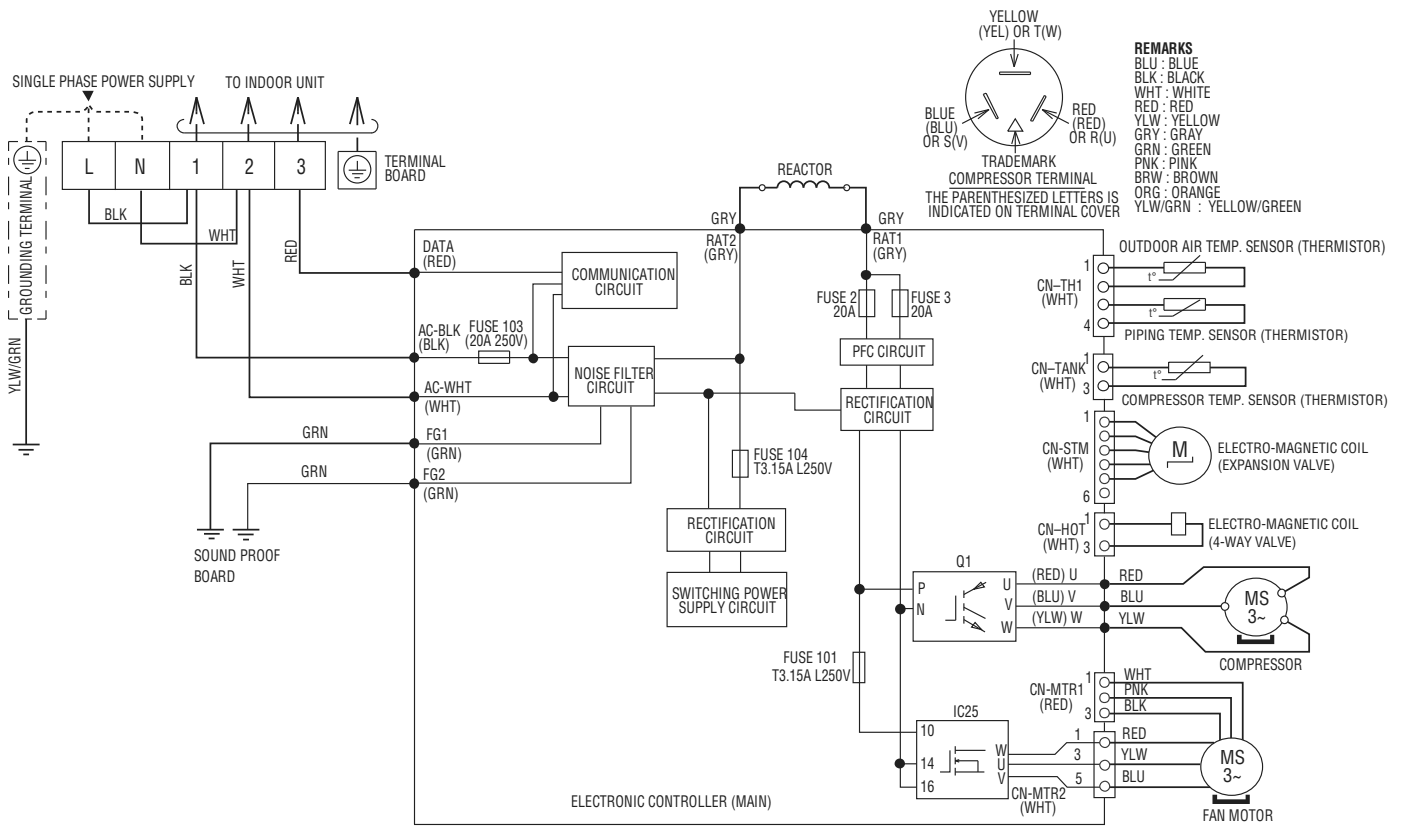

Resistance of Compressor Windings

MODEL	CU-Z25UBEA / CU-Z35UBEA
CONNECTION	9RS102XFA21 (Ω)
U-V	1.211
U-W	1.211
V-W	1.211

Note: Resistance at 20°C of ambient temperature.

9.2.2 CU-Z50UBEA CU-Z60UBEA

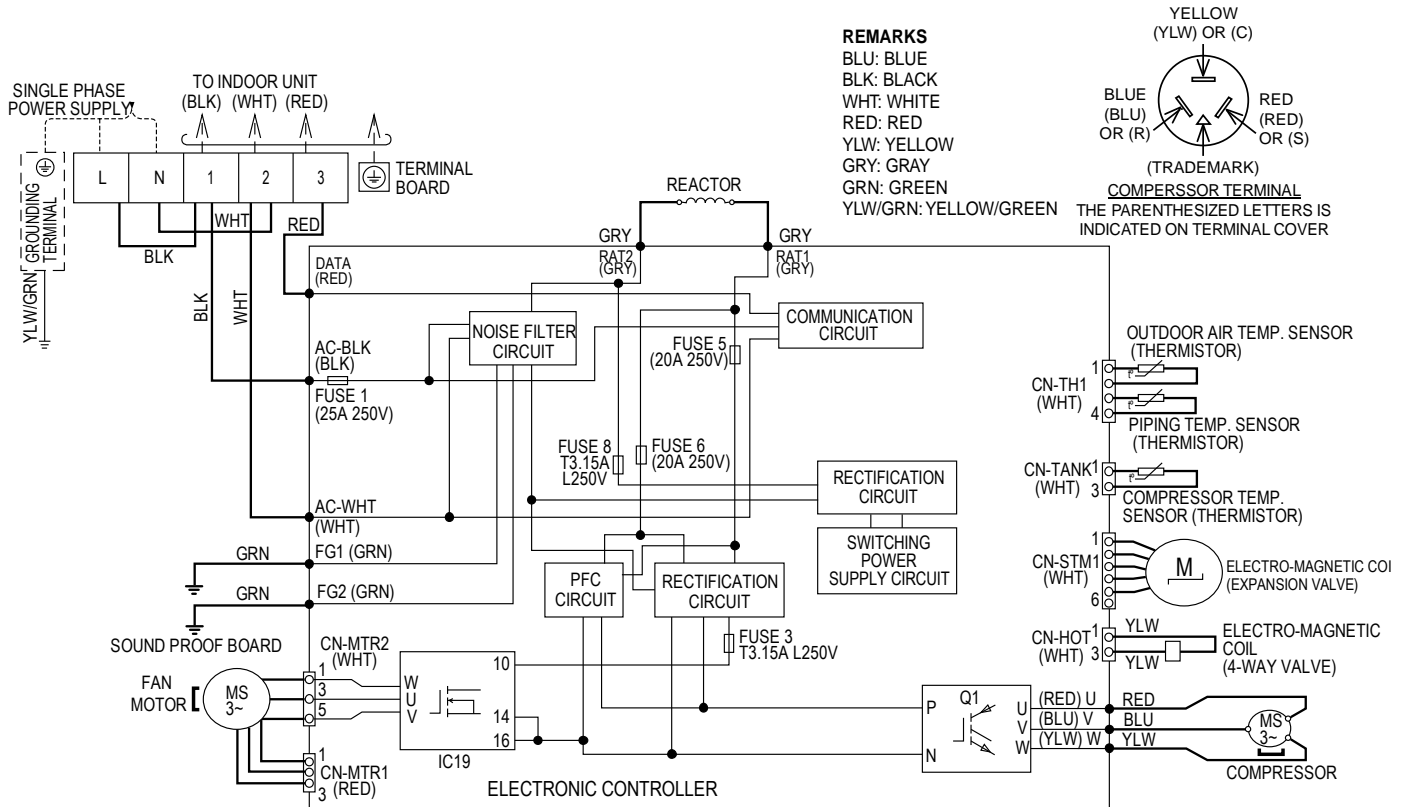

Resistance of Compressor Windings

MODEL	CU-Z50UBEA / CU-Z60UBEA
CONNECTION	9RD132XAA21 (Ω)
U-V	1.897
U-W	1.907
V-W	1.882

Note: Resistance at 20°C of ambient temperature.

10. Electronic Circuit Diagram

10.1 Indoor Unit

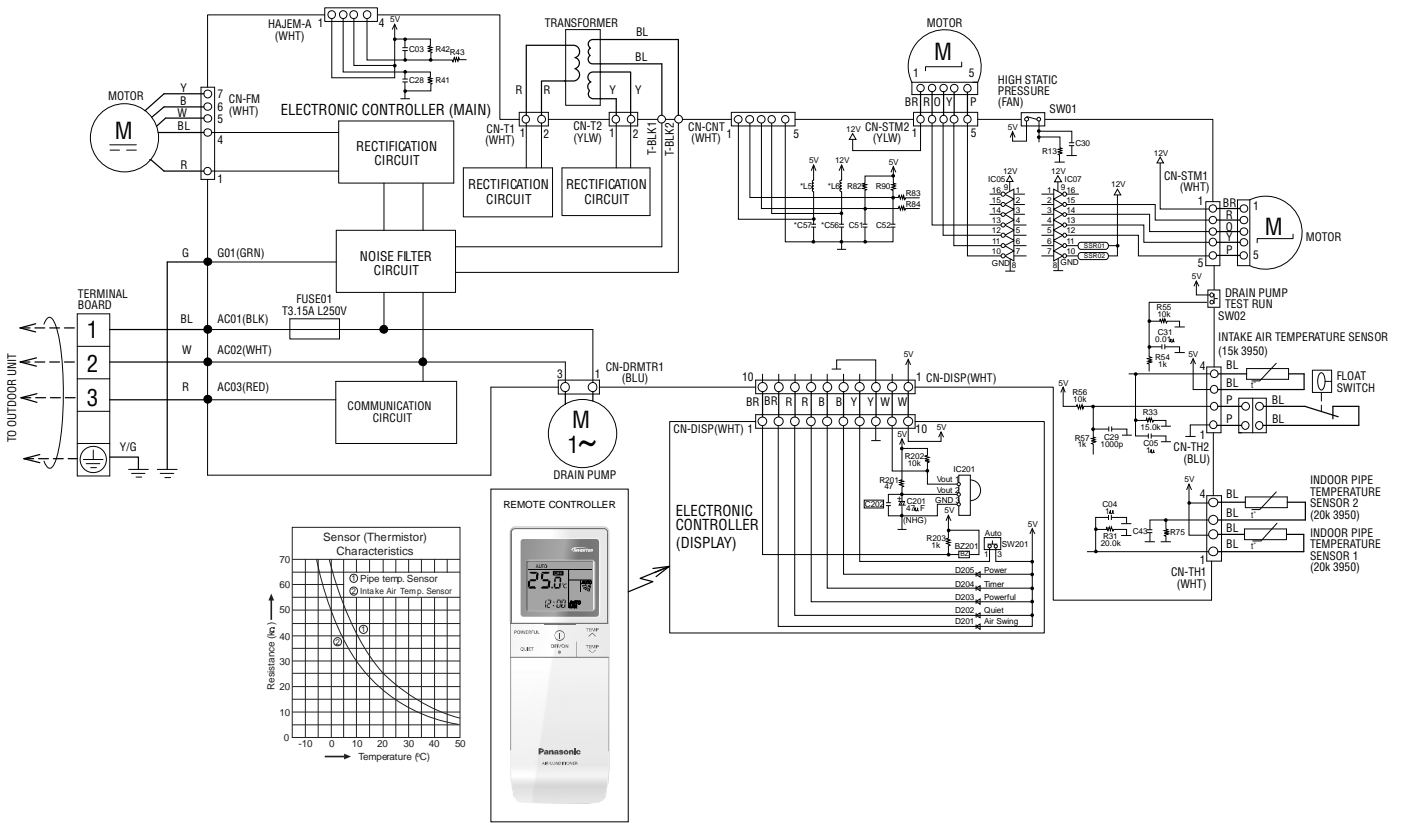

10.2 Outdoor Unit

10.2.1 CU-Z25UBEA CU-Z35UBEA

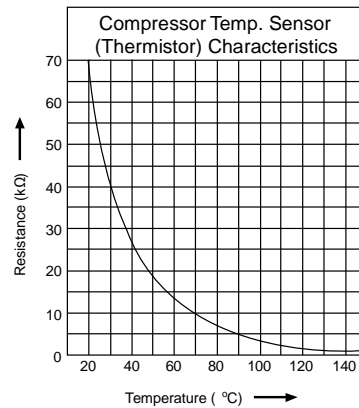
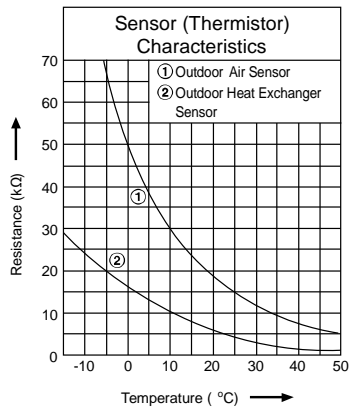
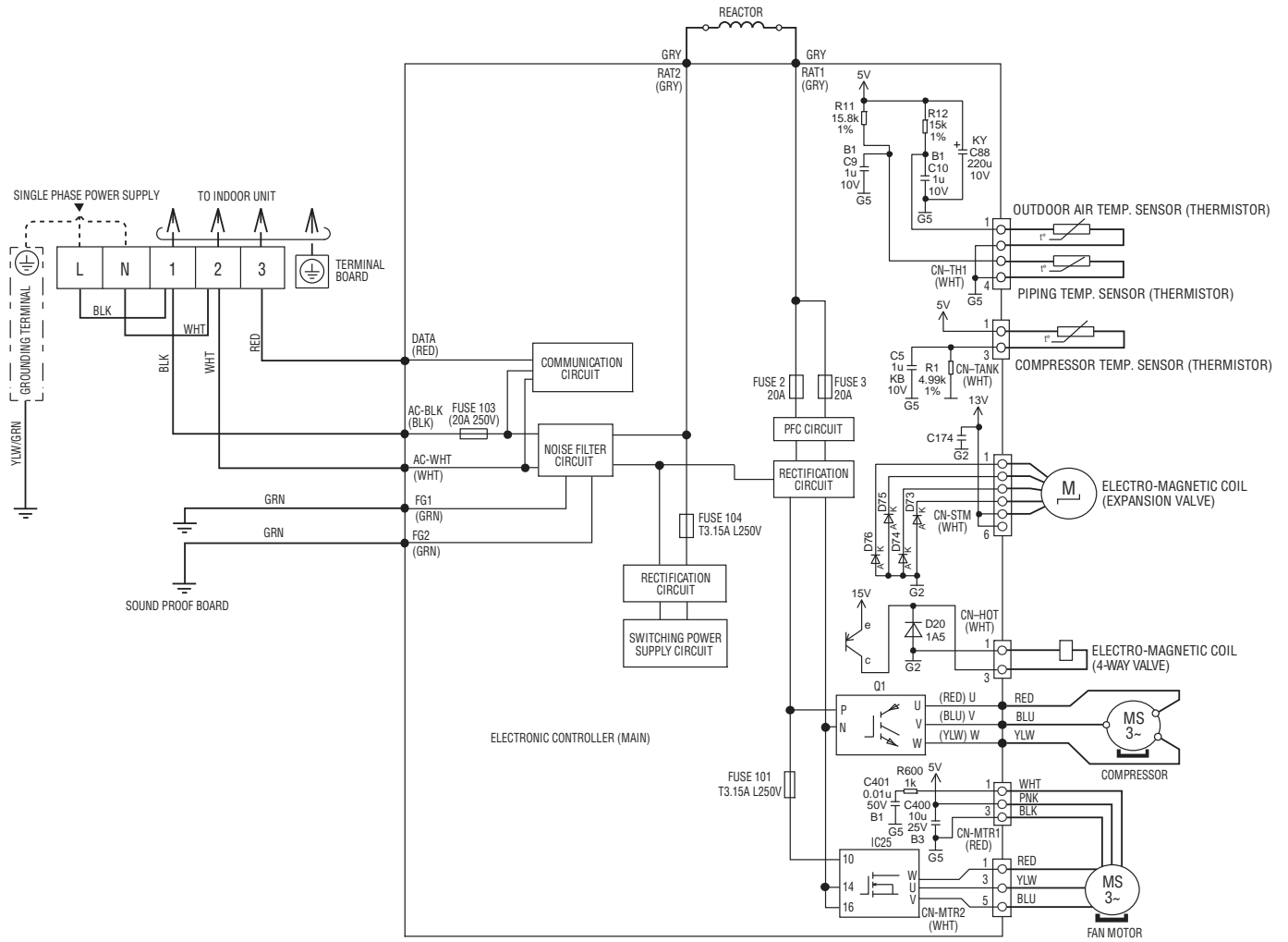

10.2.2 CU-Z50UBEA CU-Z60UBEA

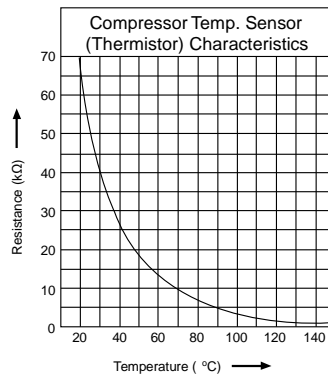
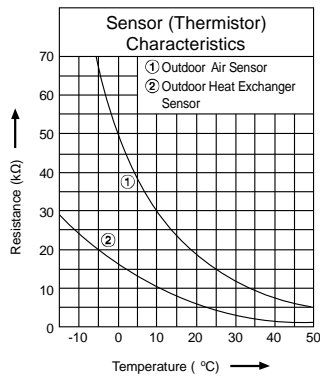
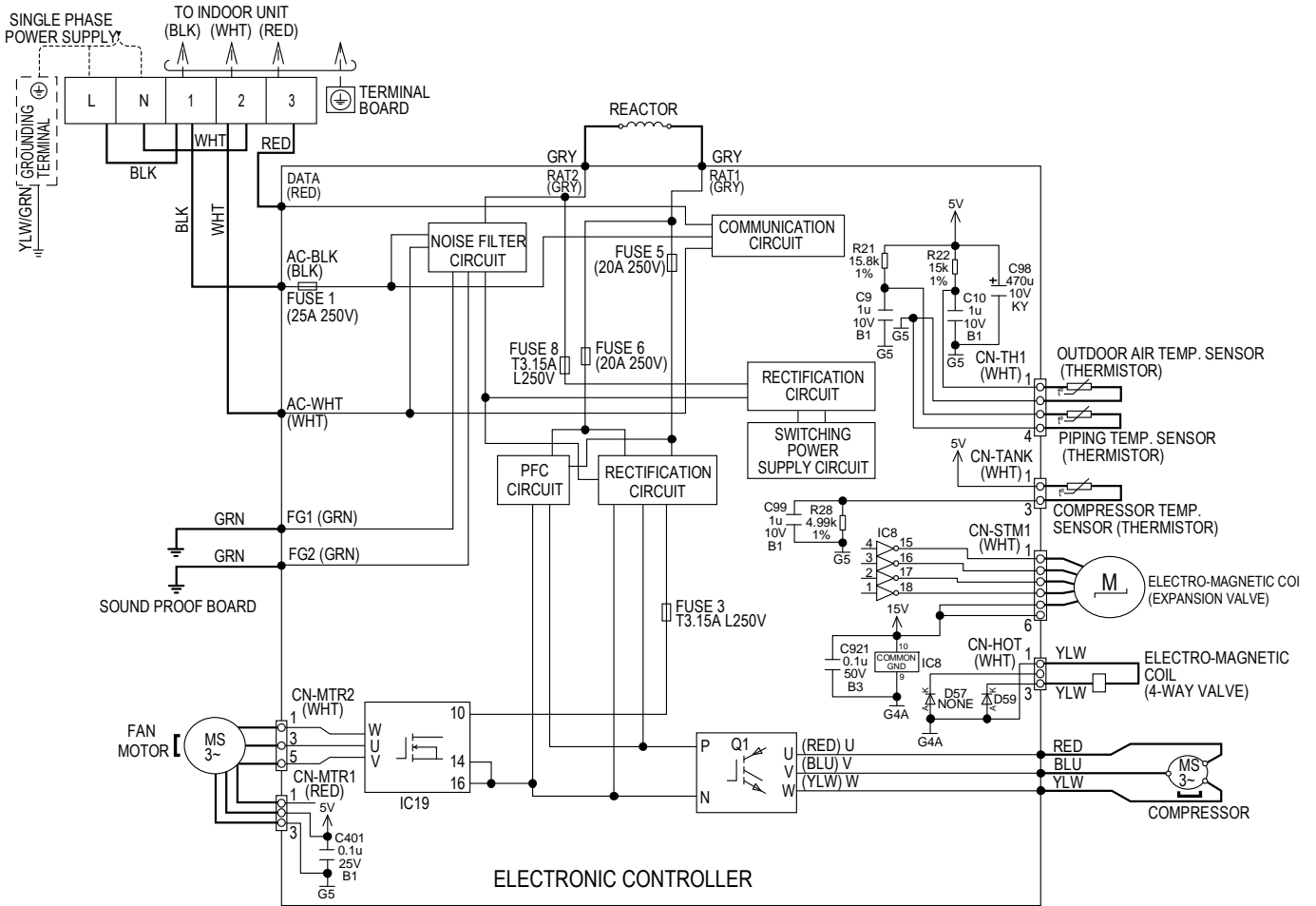

11. Printed Circuit Board

11.1 Indoor Unit

11.1.1 Main Printed Circuit Board

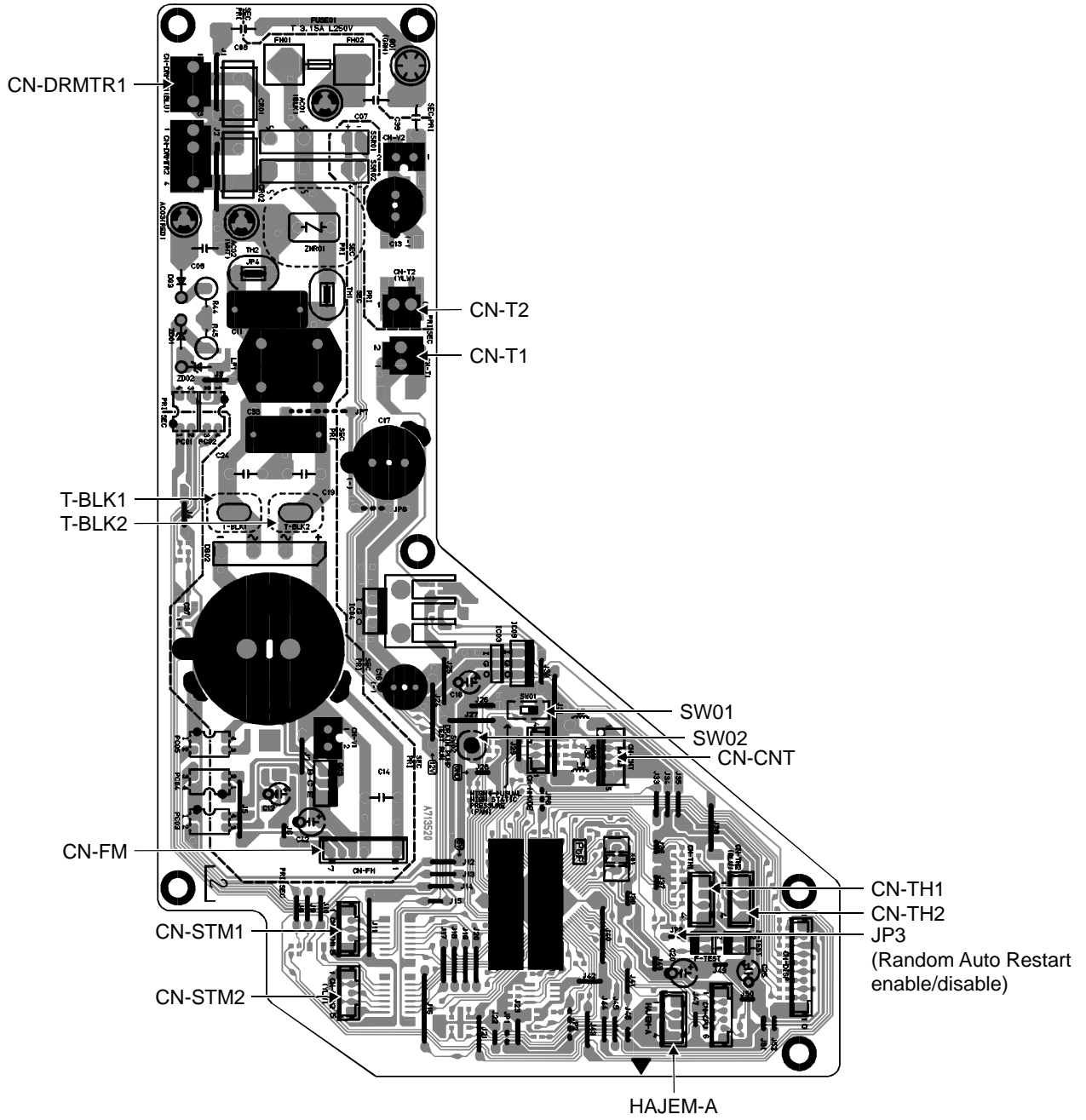

11.1.2 Display Printed Circuit Board

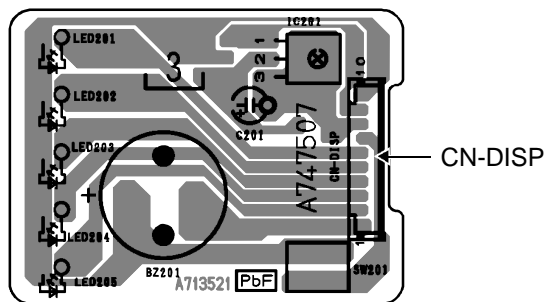

11.2 Outdoor Unit

11.2.1 Main Printed Circuit Board

11.2.1.1 CU-Z25UBEA CU-Z35UBEA

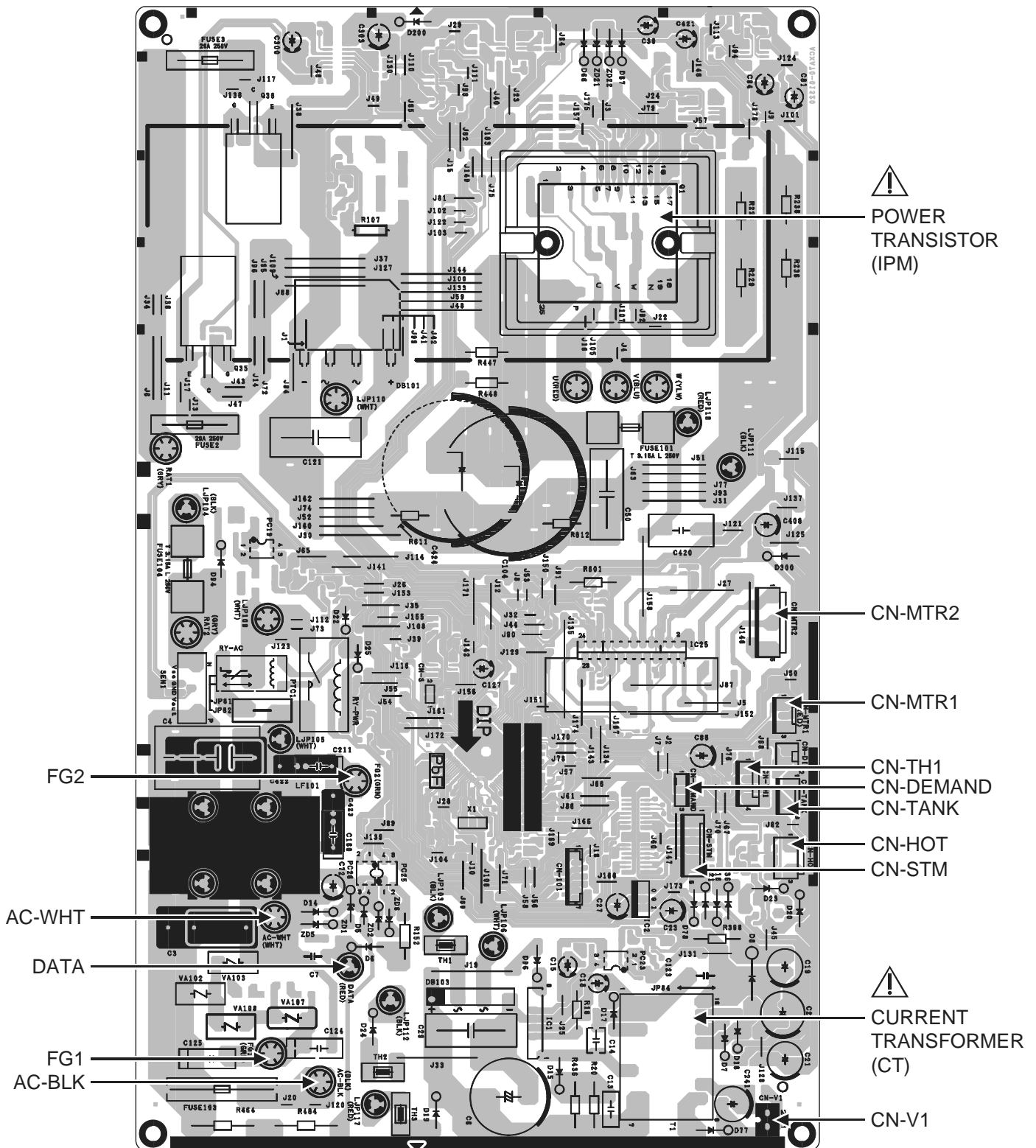

11.2.1.2 CU-Z50UBEA CU-Z60UBEA

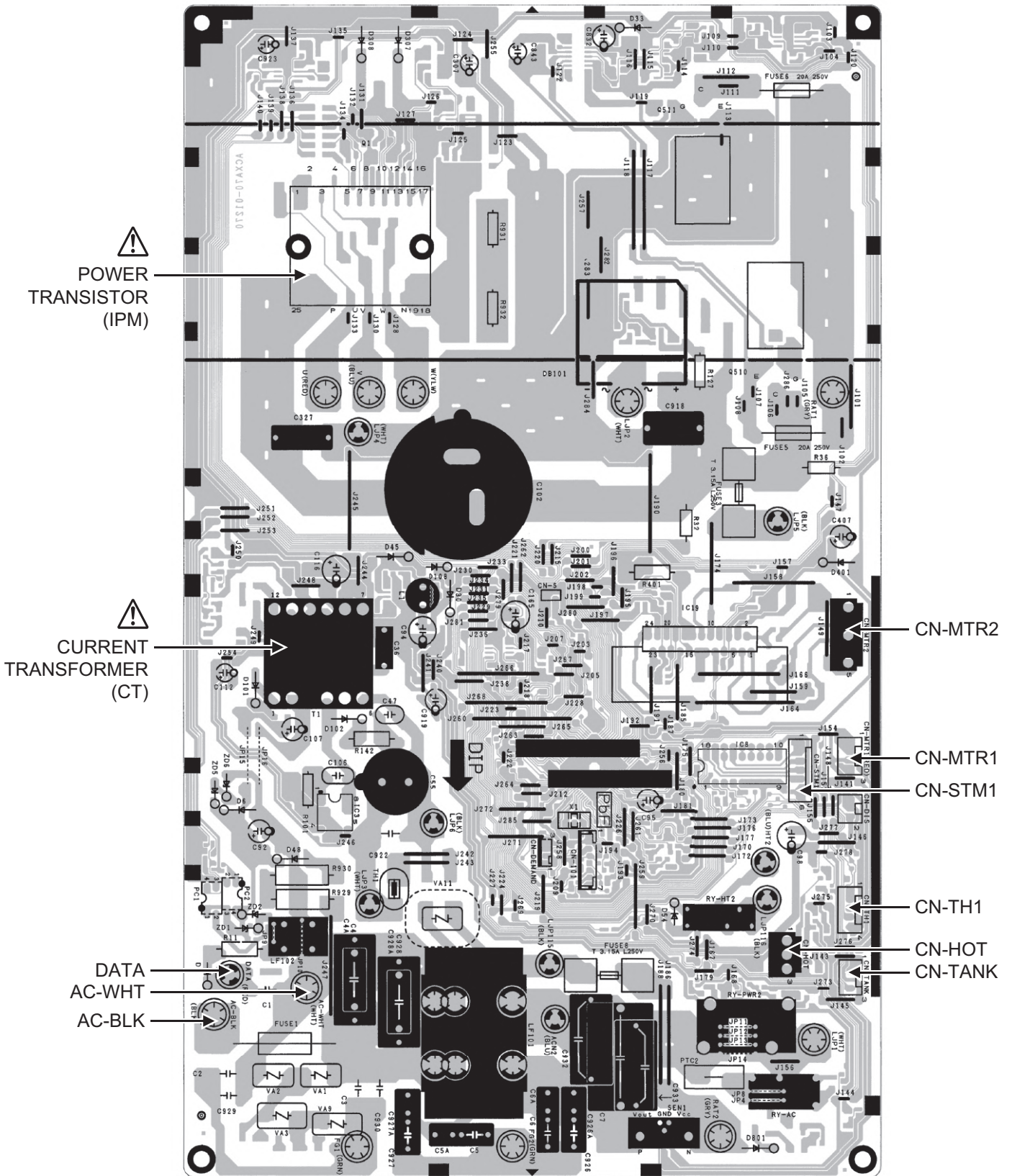

12. Installation Instruction

12.1 Indoor Unit

Required Materials

- Read the catalog and other technical materials and prepare the required materials.
- Applicable piping kit

Applicable piping kit	Piping size	
	Gas	Liquid
CZ-3F5, 7BP	9.52 mm (3/8")	6.35 mm (1/4")
CZ-4F5, 7, 10BP	12.7 mm (1/2")	6.35 mm (1/4")
CZ-52F5, 7, 10BP	15.88 mm (5/8")	6.35 mm (1/4")

- Pipe Size Reducer (CZ-MA1P) and Expander (CZ-MA2P) for Outdoor Multi Connection CS-Z50*****, CS-Z60*****
- Please refer to "Connect the piping".

Table A

Model	Capacity	Indoor A _{min} (m ²)	
		2.2m for mini cassette	2.5m for mini cassette
Z25*****	1.0HP	0.64	0.50
Z35*****	1.5HP	0.71	0.55
Z50*****	2.0HP	1.37	1.06
Z60*****	2.25HP	1.37 </td <td>1.06</td>	1.06

* Table "A" only applicable for single split connection.

* In case of connection to outdoor multi inverter, refer to installation manual at outdoor unit.

$$A_{min} = (M / (2.5 \times (LFL)^{(5/4)} \times h_0))^2$$

A_{min} = Required minimum room area, in m²

M = Refrigerant charge amount in appliance, in kg

LFL = Lower flammable limit (0.306 kg/m³)

h_0 = Installation height of the appliance :

(2.2m for mini cassette is standard reference installed height)

(2.5m for mini cassette is minimum installed height given by manufacturer)

12.1.1 Indoor Installation Diagram

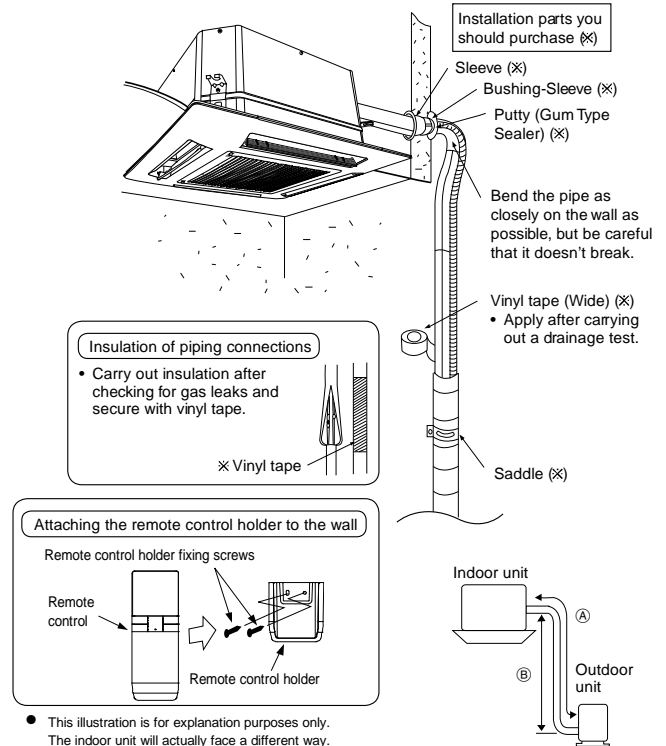

12.1.2 Selecting the Location for the Indoor Unit

Provide a check port on the piping side ceiling for repair and maintenance.

- Install the indoor unit once the following conditions are satisfied and after receiving the customer approval.
 - 1 The indoor unit must be within a maintenance space.
 - 2 The indoor unit must be free from any obstacles in path of the air inlet and outlet, and must allow spreading of air throughout the room.
 - 3 Recommended installation height for indoor unit shall be at least 2.5 m.

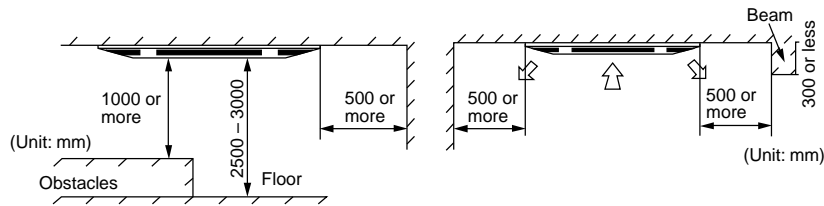

* If the height from the floor to ceiling exceeds three meters, air flow distribution deteriorates and the effect is decreased.

Warning

- 4 The installation position must be able to support a load four times the indoor unit weight.
- 5 The indoor unit must be away from heat and steam sources, but avoid installing it near an entrance.
- 6 The indoor unit must allow easy draining.
- 7 The indoor unit must allow easy connection to the outdoor unit.
- 8 Place the indoor unit according to the height from the ceiling shown in the illustration below.
- 9 The indoor unit must be from at least 3m away from any noise-generating equipment. The electrical wiring must be shielded with a steel conduit.
- 10 If the power supply is subject to noise generation, add a suppressor.
- 11 Do not install the indoor unit in a laundry. Electric shocks may result.

Note

- Thoroughly study the following installation locations

- 1 In such places as restaurants and kitchens, considerable amount of oil steam and flour adhere to the turbo fan, the fin of the heat exchanger and the drain pump, resulting in heat exchange reduction, spraying, dispersing of water drops, drain pump malfunction, etc.
In these cases, take the following actions:
 - Make sure that the ventilation fan for smoke-collecting hood on a cooking table has sufficient capacity so that it draws oily steam which should not flow into the suction of the air conditioner.
 - Make enough distance from the cooking room to install the air conditioner in such place where it may not suck in oily steam.

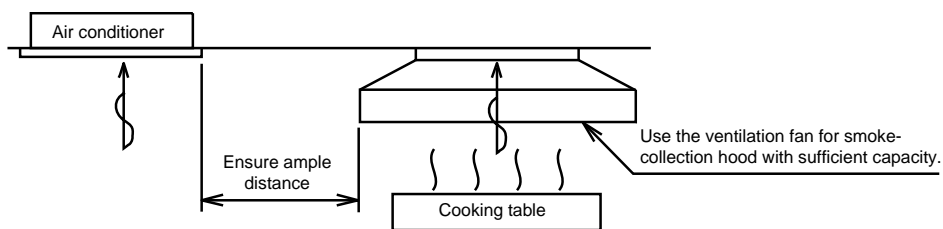

- 2 Avoid installing the air conditioner in such circumstances where cutting oil mist or iron powder exist especially in factories, etc.
- 3 Avoid places where inflammable gas is generated, flows-in, contaminated, or leaked.
- 4 Avoid places where sulphurous acid gas or corrosive gas can be generated.
- 5 Avoid places near high frequency generators.

Model Name	Height in the ceiling
MZ20***** Z25***** Z35***** Z50***** Z60*****	280 mm or more

12.1.3 Installation of Indoor Unit

This air conditioner uses a drain up motor.
Horizontally install the unit using a level gauge.

CEILING OPENING DIMENSIONS AND HANGING BOLT LOCATION

The paper model for installation expand or shrink according to temperature and humidity.
Check on dimensions before using it.

Caution During the installation, care must be taken not to damage electric wires.

- The dimensions of the paper model for installation are the same as those of the ceiling opening dimensions.
- Be sure to discuss the ceiling drilling work with the workers concerned.

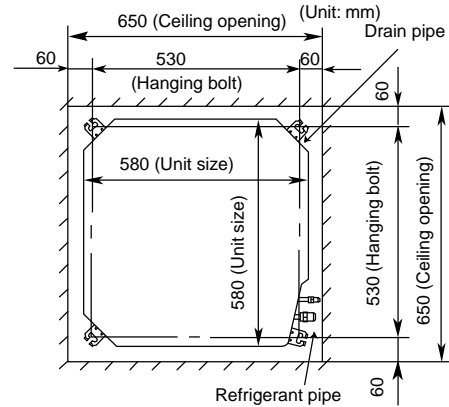

POSITIONS OF AIR CONDITIONER BODY AND CEILING SURFACE

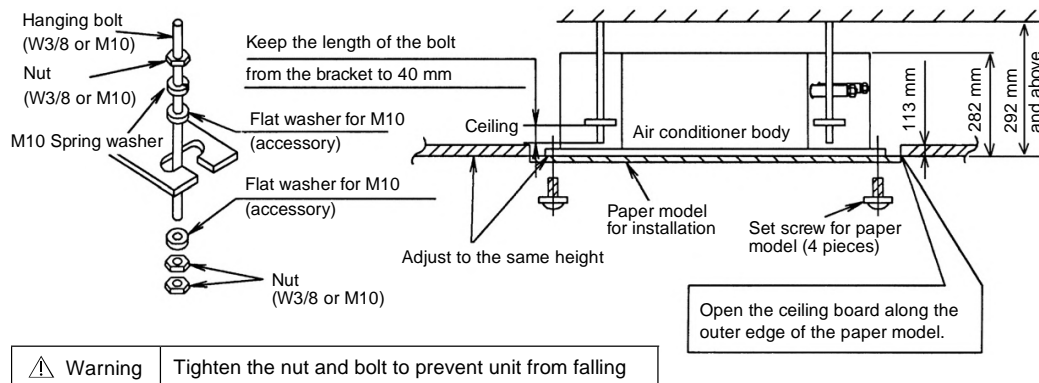

Warning Tighten the nut and bolt to prevent unit from falling

12.1.4 Refrigerant Piping

Refrigerant is charged to the outdoor unit. For details, see the manual for installation work of outdoor unit. (Additional charging, etc.)

- 1 Brazing for piping.
 - a. Execute brazing before tightening the flare nut.
 - b. Brazing must be executed while blowing nitrogen gas. (This prevents generation of oxidized scale in copper pipe.)
- 2 When there is a lot of brazings for long piping, install a strainer midway of the piping. (The strainer is locally supplied.)
- 3 Use clean copper pipe with inner wall surface free from mist and dust. Blow nitrogen gas or air to blow off dust in the pipe before connection.
- 4 Form the piping according to its routing. Avoid bending and bending back the same piping point more than three times. (This will result in hardening of the pipe).
- 5 After deforming the pipe, align centers of the union fitting of the indoor unit and the piping, and tighten them firmly with wrenches.
- 6 Connect pipe to the service valve or ball valve which is located below the outdoor unit.
- 7 After completed the piping connection, be sure to check if there is gas leakage in indoor and outdoor connection.

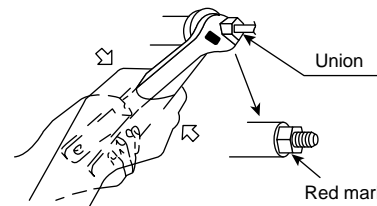

- Confirm the red mark of the union (thin side) is always at lower direction after connecting piping.

Vacuum drying

After completing the piping connection, execute vacuum drying for the connecting piping and the indoor unit.

The vacuum drying must be carried out by using the service ports of both the liquid and gas side valves.

CAUTION Use two wrenches and tighten with regular torque.

Do not overtighten, overtightening may cause gas leakage.

Piping size	Torque
6.35 mm (1/4")	[18 N•m (1.8 kgf•cm)]
9.52 mm (3/8")	[42 N•m (4.3 kgf•cm)]
12.7 mm (1/2")	[55 N•m (5.6 kgf•cm)]
15.88 mm (5/8")	[65 N•m (6.6 kgf•cm)]
19.05 mm (3/4")	[100 N•m (10.2 kgf•cm)]

12.1.5 Indoor Unit Drain Piping

- During drain piping connection, be careful not to exert extra force on the drain port at the indoor unit.
- The outside diameter of the drain connection at the indoor unit is 32 mm.

Piping material: Polyvinyl chloride pipe VP-25 and pipe fittings.

- Be sure to perform heat insulation on the drain piping.

Heat insulation material: Polyethylene foam with thickness more than 8 mm (local supply).

- Drain piping must have down-slope (1/50 to 1/100); be sure not to provide up-and-down slope to prevent reversal flow.
- Be sure to check no air trap on drain hose and to ensure smooth water flow and no abnormal sound.

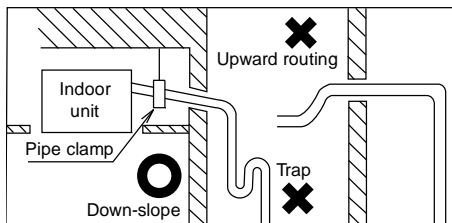

- When drain set piping, install as shown in the figure below.

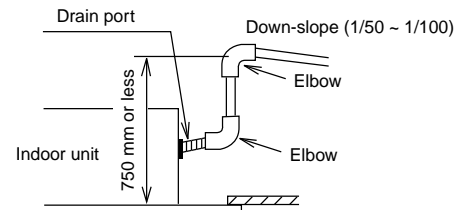

- The height of drain may be possible up to 750 mm.

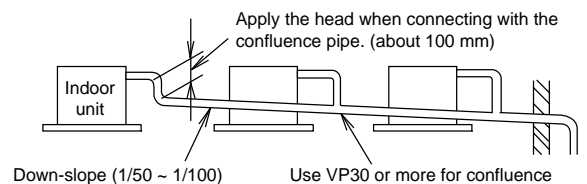
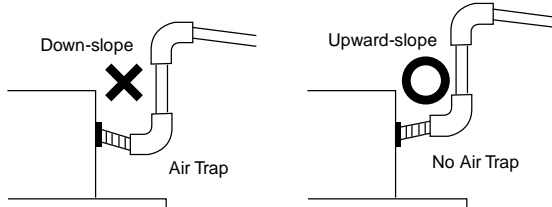

Drain Test

The air conditioner uses a drain up motor to drain water. Use the following procedure to test the drain up motor operation.

- Connect the main drain pipe to exterior and leave it provisionally until the test comes to an end.
- Feed water to the flexible drain hose and check the piping for leakage.
- Be sure to check the drain up motor for normal operating and noise when electric wiring is complete.
- When the test is complete, connect the flexible drain hose to the drain port.
- Pour about 600-700cc of water in the drain pan of the indoor unit. (Pour from the position specified in the drawing by using a water supply bottle or other suitable tool.)
- Press the drain pump test run on pcb to start the drain motor, and verify water drainage. (The drain motor will automatically stop after operating for about five minutes.)

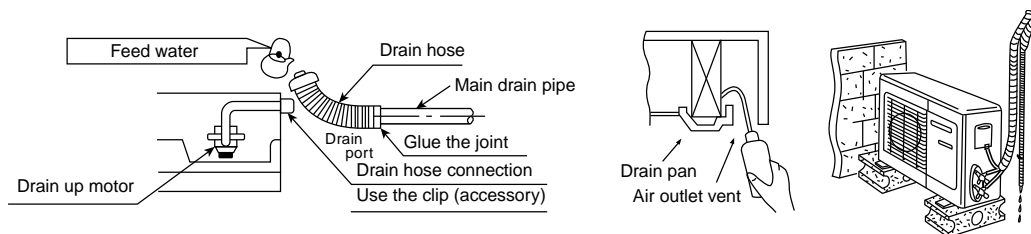

12.1.6 Heat Insulation

Caution Be sure to perform heat insulation on the drain, liquid and gas piping. Imperfection in heat insulation work leads to water leakage.

- Use the heat insulation material for the refrigerant piping which has an excellent heat-resistance (over 120°C).

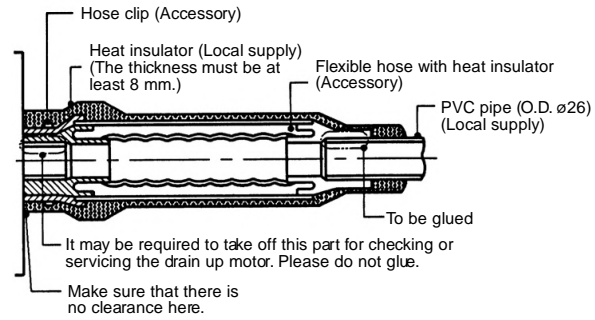
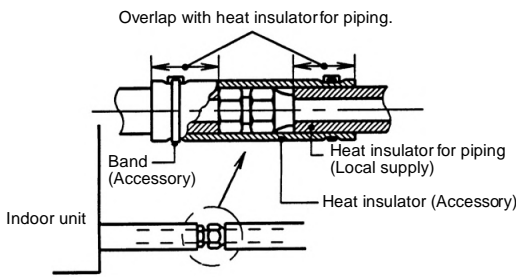

- Precautions in high humidity circumstance.

This air conditioner has been tested according to the "JIS Standard Conditions with Mist" and have been confirmed that there are no faults. However, if it is operated for a long time in high humid atmosphere (dew point temperature: more than 23°C), water drops are liable to fall. In this case, add heat insulation material according to the following procedure:

- Heat insulation material to be prepared... Adiabatic glass wool with thickness 10 to 20 mm.
- Stick glass wool on all air conditioners that are located in ceiling atmosphere.
- In addition to the normal heat insulation (thickness: more than 8 mm) for refrigerant piping (gas piping: thick piping) and drain piping, add a further of 10 mm to 30 mm thickness material.

Wall seal

- When the outdoor unit is installed on a higher position than the indoor unit, install the trap so as not to instill rain water into the wall by transmitting in piping.
- Stuff the space among piping, the electric wire, and- the drain hose with "Putty" and seal the penetration wall hole. Make sure that rain water do not instill into the wall.

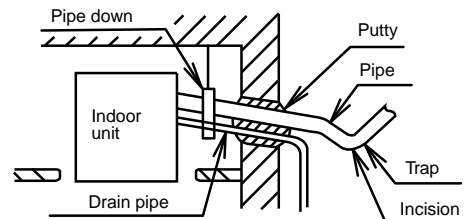

* Put the incision at the trap part of the heat insulator (for water drain)

12.1.7 Connecting the Cable to the Indoor

- Remove the mounting screw, remove the control box cover, and then connect the wires by following the procedure given in the illustration.
- Connection cable between indoor unit and outdoor unit shall be approved polychloroprene sheathed 4 x 1.5 mm² flexible cord, type designation 60245 IEC 57 or heavier cord. Allowable connection cable length of each indoor unit shall be 30 m or less.
- Secure the connection cable onto the control board with the holder (clammer).
- Ensure the colour of wires of outdoor unit and the terminal Nos. are the same to the indoor's respectively.
- Earth wire shall be Yellow/Green (Y/G) in colour and longer than other AC wires for safety reason.

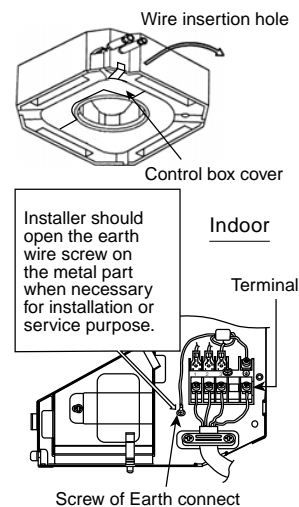

Terminals on the indoor unit	1	2	3	
Colour of wires				
Terminals on the outdoor unit	1	2	3	

WARNING
 This equipment must be properly earthed.

12.1.7.1 Wire Stripping and Connection Requirement

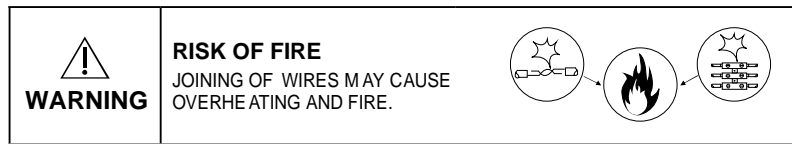
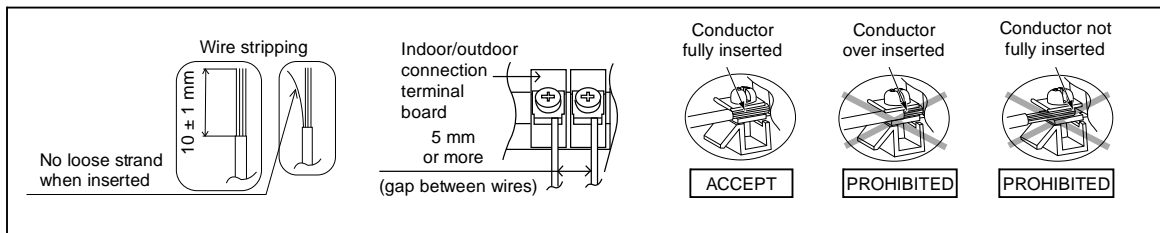

Do not joint wires

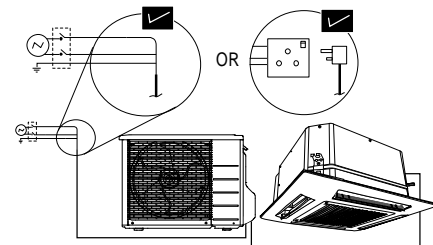
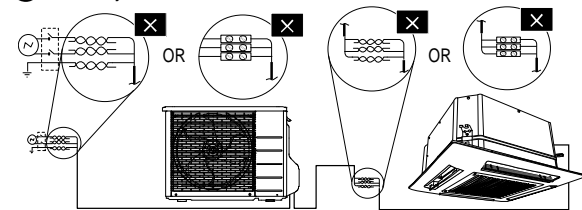

- ❗ Use complete wire without joining.
- ❗ Use approved socket and plug with earth pin.
- ❗ Wire connection in this area must follow to national wiring rules.

12.1.8 Installation of Decorative Panel

The decorative panel has its installation direction. Confirm the direction by displaying the piping side.

- 1 Remove the air inlet grille by moving the catchers to center.

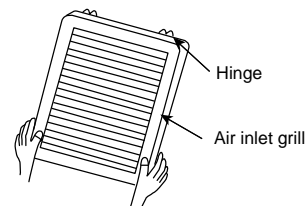
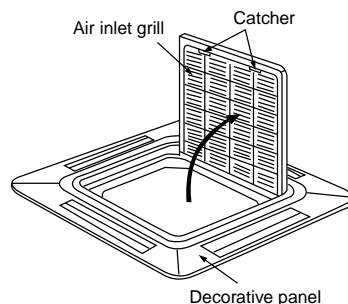

* Hang the hinge on the hole of decorative panel. (The direction of the installation is free.)

- 2 Fitting the decorative panel
 - Temporarily secure the fixing screws (3 pcs.) before fitting the decorative panel. (For temporarily securing the front grille.)
 - Place decorative panel on the screws (3 pcs.) before fitting, move decorative panel as illustrated and tighten all the screws (4 pcs.).

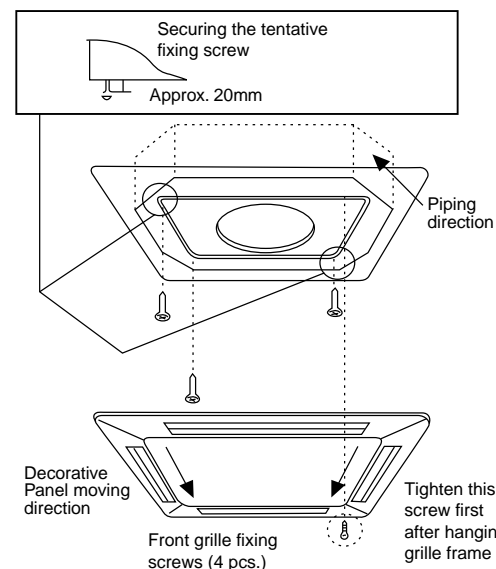

⚠ CAUTION

- Check before hand the height from the ceiling to the unit.
- The front grille fitting direction is determined by the unit direction.
- Only use the screws with the length of 35mm which is provided, to fix the decorative panel.
- Do not use other screw which is longer it may cause damage to the drain-pan and other components.

- 3 Fit the decorative panel and ceiling wall together and confirm no gap in between. Readjust indoor unit height, if there is a gap between ceiling wall and decorative panel.

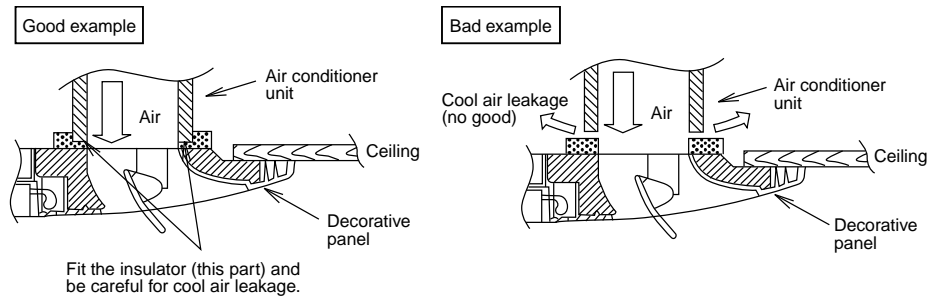

- 4 Open the indoor control box cover. (2 pcs)
 5 Insert firmly the connector of cosmetic louver to indoor pcb CN-STM1, CN-STM2 and CN-DISP.
 Be caution not to clamp the cord in between control board and control board cover.
 6 After complete, install back removed part follow opposite procedure.

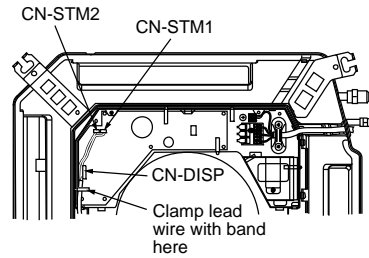

Warning Be sure to hook the air inlet grill string, to prevent grill from falling and causing injury from it.

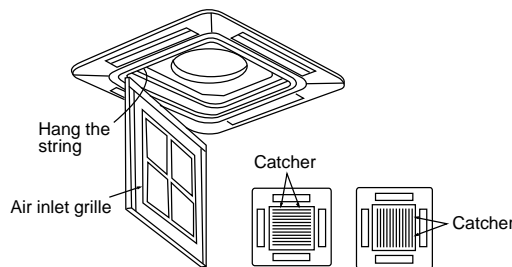

12.1.9 Connect the Piping

12.1.9.1 Connecting The Piping to Indoor

For connection joint of all model (except R32 model)	For connection joint of R32 models
<p>Please make flare after inserting flare nut (locate at joint portion of tube assembly) onto the copper pipe. (In case of using long piping)</p> <p>Connect the piping</p> <ul style="list-style-type: none"> Align the center of piping and sufficiently tighten the flare nut with fingers. Further tighten the flare nut with torque wrench in specified torque as stated in the table. <p>Spanner or Wrench Torque wrench</p>	<ul style="list-style-type: none"> Decide the length. Cut and remove the tube connectors at indoor copper pipings (both gas and liquid piping) by using pipe cutter. Remove burrs from cut edge. Use pipe expander to expand the end of long piping. Align the center of piping and braze the piping joints. <p>1. Cut and Remove 2. Expand long pipe 3. Braze both pipe</p> <ul style="list-style-type: none"> Braze the piping joints carefully so that the indoor unit is not damaged by brazing flame. If necessary, cover with wet clothes to prevent parts unintentionally overburnt.

12.1.9.2 Connecting The Piping to Outdoor

Decide piping length and then cut by using pipe cutter. Remove burrs from cut edge. Make flare after inserting the flare nut (locate at valve) onto the copper pipe. Align center of piping to valve and then tighten with torque wrench to the specified torque as stated in the table.

12.1.9.3 Connecting The Piping to Outdoor Multi

Decide piping length and then cut by using pipe cutter. Remove burrs from cut edge. Make flare after inserting the flare nut (locate at valve) onto the copper pipe. Align center of piping to valve and then tighten with torque wrench to the specified torque as stated in the table.

* For Gas side piping please refer table and diagram below

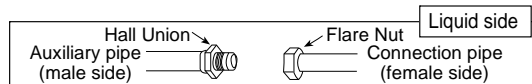

Outdoor Multi Combination Model				
	R410A Model	Pipe size (refer to diagram)	R32 Model	Pipe size (refer to diagram)
CS-MZ20* CS-Z25* CS-Z35*	CU-2E12* CU-2E15* CU-2E18* CU-3E18* CU-3E23* CU-4E23* CU-4E27* CU-5E34*	①	CU-2Z35* CU-2Z41* CU-2Z50* CU-3Z52* CU-3Z68* CU-4Z68* CU-4Z80* CU-5Z90*	④
CS-Z50*	CU-2E18* CU-3E18* CU-3E23* CU-4E23* CU-4E27* CU-5E34*	② (CZ-MA1P)	CU-2Z50* CU-3Z52* CU-3Z68* CU-4Z68* CU-4Z80* CU-5Z90*	④
CS-Z60*	CU-3E23* CU-4E23* CU-4E27* CU-5E34*	③ (CZ-MA2P)	CU-3Z68* CU-4Z68* CU-4Z80* CU-5Z90*	⑤ (CZ-MA2P)

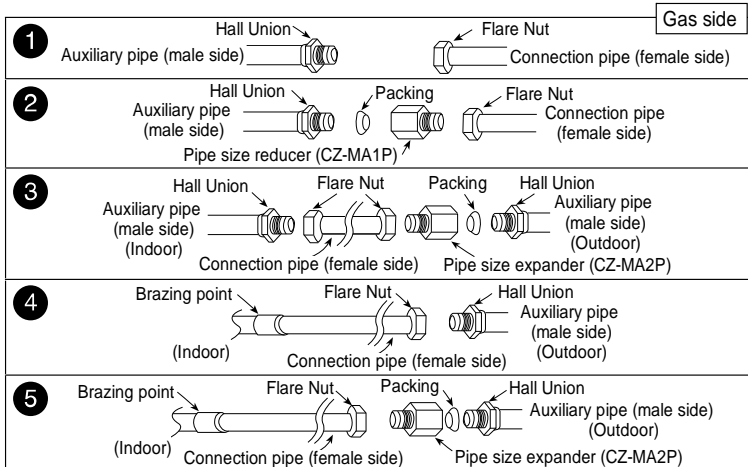

12.2 Outdoor Unit

12.2.1 Select the Best Location

- If an awning is built over the unit to prevent direct sunlight or rain, be careful that heat radiation from the condenser is not obstructed.
- There should not be any animal or plant which could be affected by hot air discharged.
- Keep the spaces indicated by arrows from wall, ceiling, fence or other obstacles.
- Do not place any obstacles which may cause a short circuit of the discharged air.
- If piping length is over the [piping length for additional gas], additional refrigerant should be added as shown in the table.

Model	Horse Power (HP)	Piping size		Std. Length Ø (m)	Max. Elevation Ø (m)	Min. Piping Length (m)	Max. Piping Length (m)	Additional Refrigerant (g/m)	Piping Length for add. gas (m)	Indoor A_{min} (m ²)		Indoor A_{min} (m ²)		Indoor A_{min} (m ²)
		Gas	Liquid							2.2m for mini cassette	2.5m for mini cassette	2.2m for ducted	2.5m for ducted	0.6m for floor console
Z25****	1.0HP	9.52mm	6.35mm (1/4")	5	15	3	20	10	7.5	0.64	0.50	0.64	0.50	8.67
Z35****	1.5HP	(3/8")			15	3	20	10	7.5	0.71	0.55	0.71	0.55	9.55
Z50****	2.0HP	(1/2")			20	3	30	15	7.5	1.37	1.06	1.37	1.06	18.46
Z60****	2.25HP	(1/2")			20	3	30	15	7.5	1.37	1.06	1.37	1.06	N/A

Example: For Z25****

If the unit is installed at 10 m distance, the quantity of additional refrigerant should be 25 g (10-7.5) m x 10 g/m = 25 g.

$$A_{min} = (M / (2.5 \times (LFL)^{(5/4)} \times h_0))^2$$

A_{min} = Required minimum room area, in m²

M = Refrigerant charge amount in appliance, in kg

LFL = Lower flammable limit (0.306 kg/m³)

h_0 = Installation height of the appliance : (2.2m for mini cassette & ducted is standard reference installed height)
(2.5m for mini cassette & ducted is minimum installed height given by manufacturer)
(0.6m for floor console)

12.2.2 Install the Outdoor Unit

- After selecting the best location, start installation according to Indoor/Outdoor Unit Installation Diagram.
 - 1 Fix the unit on concrete or rigid frame firmly and horizontally by bolt nut (Ø10 mm).
 - 2 When installing at roof, please consider strong wind and earthquake. Please fasten the installation stand firmly with bolt or nails.

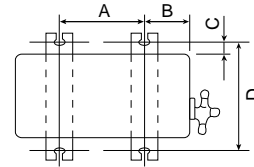

Model	A	B	C	D
Z25****	570 mm	105 mm	18.5 mm	320 mm
Z35****	540 mm	160 mm	18.5 mm	330 mm
Z50****	613 mm	131 mm	24 mm	360.5 mm
Z60****				

12.2.1.1 Outdoor Installation Diagram

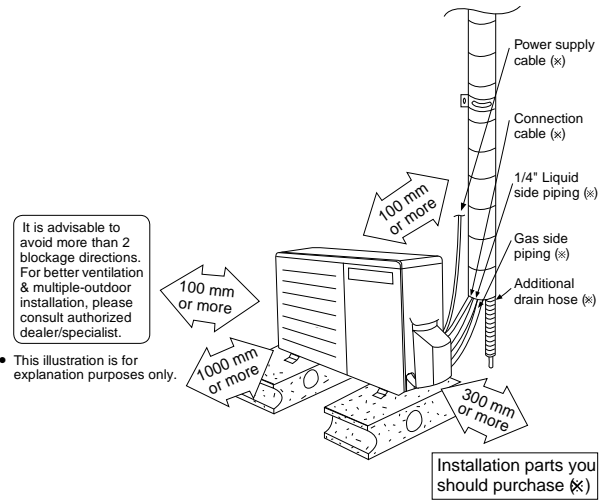

12.2.3 Connect the Piping

12.2.3.1 Connecting the Piping to Indoor

For connection joint location at outside building
Please make flare after inserting flare nut (locate at joint portion of tube assembly) onto the copper pipe.
(In case of using long piping)

Connect the piping

- Align the center of piping and sufficiently tighten the flare nut with fingers.
- Further tighten the flare nut with torque wrench in specified torque as stated in the table.

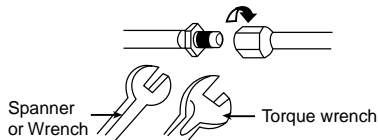

For connection joint location at inside building

- Refer to indoor installation instruction.

12.2.3.2 Connecting the Piping to Outdoor

Decide piping length and then cut by using pipe cutter. Remove burrs from cut edge. Make flare after inserting the flare nut (locate at valve) onto the copper pipe. Align center of piping to valve and then tighten with torque wrench to the specified torque as stated in the table.

Do not overtighten, overtightening may cause gas leakage	
Piping size	Torque
6.35 mm (1/4")	[18 N•m (1.8 kgf•m)]
9.52 mm (3/8")	[42 N•m (4.3 kgf•m)]
12.7 mm (1/2")	[55 N•m (5.6 kgf•m)]
15.88 mm (5/8")	[65 N•m (6.6 kgf•m)]
19.05 mm (3/4")	[100 N•m (10.2 kgf•m)]

12.2.4 Evacuation of the Equipment

WHEN INSTALLING AN AIR CONDITIONER, BE SURE TO EVACUATE THE AIR INSIDE THE INDOOR UNIT AND PIPES in the following procedure.

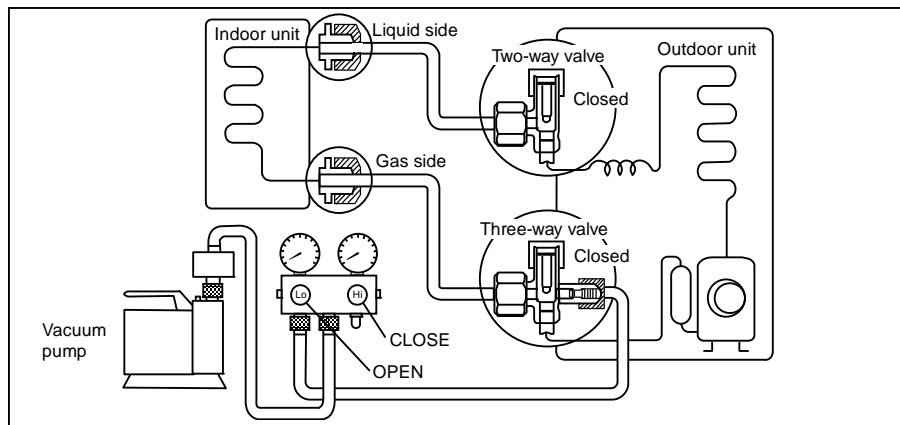

- 1 Connect a charging hose with a push pin to the Low side of a charging set and the service port of the 3-way valve.
 - Be sure to connect the end of the charging hose with the push pin to the service port.
- 2 Connect the center hose of the charging set to a vacuum pump.
- 3 Turn on the power switch of the vacuum pump and make sure that the needle in the gauge moves from 0 cmHg (0 MPa) to -76 cmHg (-0.1 MPa). Then evacuate the air approximately ten minutes.
- 4 Close the Low side valve of the charging set and turn off the vacuum pump. Make sure that the needle in the gauge does not move after approximately five minutes.
Note : BE SURE TO TAKE THIS PROCEDURE IN ORDER TO AVOID REFRIGERANT GAS LEAKAGE.
- 5 Disconnect the charging hose from the vacuum pump and from the service port of the 3-way valve.
- 6 Tighten the service port caps of the 3-way valve at a torque of 18 N•m with a torque wrench.

- 7 Remove the valve caps of both of the 2-way valve and 3-way valve. Position both of the valves to "OPEN" using a hexagonal wrench (4 mm).
- 8 Mount valve caps onto the 2-way valve and the 3-way valve.
 - o Be sure to check for gas leakage.

- If gauge needle does not move from 0 cmHg (0 MPa) to -76 cmHg (-0.1 MPa), in step ③ above take the following measure:
 - If the leak stops when the piping connections are tightened further, continue working from step ③.
 - If the leak does not stop when the connections are retightened, repair location of leak.
 - Do not release refrigerant during piping work for installation and reinstallation.
 - Take care of the liquid refrigerant, it may cause frostbite.

12.2.5 Connect the Cable to the Outdoor Unit

(FOR DETAIL REFER TO WIRING DIAGRAM AT UNIT)

- 1 Remove the control board cover from the unit by loosening the screw.
- 2 Cable connection to the power supply through Isolating Devices (Disconnecting means).
 - o Connect approved type polychloroprene sheathed **power supply cord** 3 x 1.5 mm² (1.0 ~ 1.5HP) or 3 x 2.5 mm² (2.0 ~ 2.25HP) type designation 60245 IEC 57 or heavier cord to the terminal board, and connect the others end of the cord to Isolating Devices (Disconnecting means).
- 3 **Connection cable** between indoor unit and outdoor unit shall be approved polychloroprene sheathed 4 x 1.5 mm² flexible cord, type designation 60245 IEC 57 or heavier cord. Allowable connection cable length of each indoor unit shall be 30 m or less.
- 4 Connect the power supply cord and connection cable between indoor unit and outdoor unit according to the diagram below.

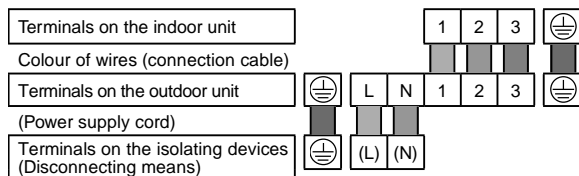

- 5 Secure the power supply cord and connection cable onto the control board with the holder.
- 6 Attach the control board cover back to the original position with screw.
- 7 For wire stripping and connection requirement, refer to instruction 12.1.6.1 of indoor unit.

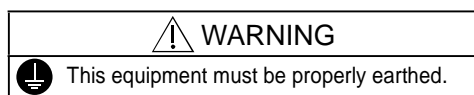

- Note: Isolating Devices (Disconnecting means) should have minimum 3.0 mm contact gap.
- Earth wire shall be Yellow/Green (Y/G) in colour and longer than other AC wires for safety reason.

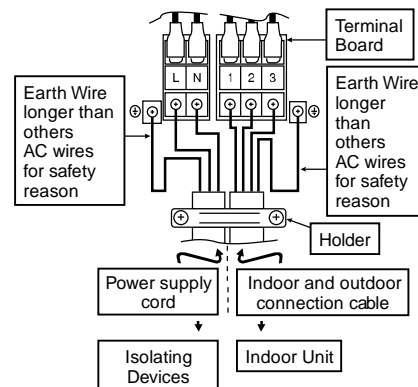

12.2.6 Pipe Insulation

- 1 Please carry out insulation at pipe connection portion as mentioned in Indoor/Outdoor Unit Installation Diagram. Please wrap the insulated piping end to prevent water from going inside the piping.
- 2 If drain hose or connecting piping is in the room (where dew may form), please increase the insulation by using POLY-E FOAM with thickness 6 mm or above.

12.2.6.1 Cutting and Flaring the Piping

- 1 Please cut using pipe cutter and then remove the burrs.
- 2 Remove the burrs by using reamer. If burrs is not removed, gas leakage may be caused. Turn the piping end down to avoid the metal powder entering the pipe.
- 3 Please make flare after inserting the flare nut onto the copper pipes.

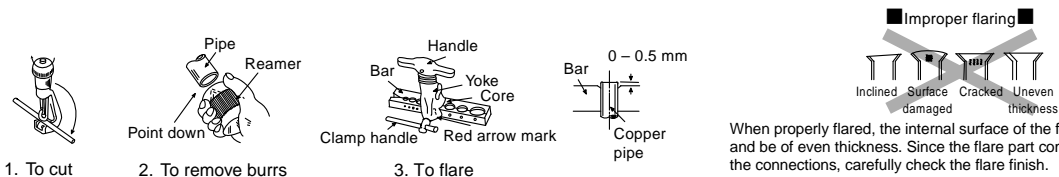

12.2.7 Disposal of Outdoor Unit Drain Water

- If a drain elbow is used, the unit should be placed on a stand which is taller than 3 cm.
- If the unit is used in an area where temperature falls below 0°C for 2 or 3 days in succession, it is recommended not to use a drain elbow, for the drain water freezes and the fan will not rotate.

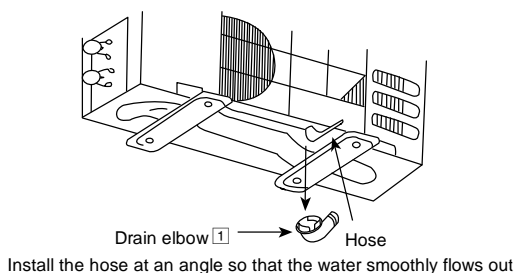

13. Installation and Servicing Air Conditioner using R32

13.1 About R32 Refrigerant

For air conditioning refrigerants such as R410A, the refrigerants were collected back in order to prevent their air dissipation, to curbe the global warming impact, in case they were released into the atmosphere. In the “4th Environmental Basic Plan”, 80% reduction of greenhouse gas emissions by 2050 is required, and due to this requirement, further reduction in the emission of high greenhouse effect gas, such as CFCs, is required. Therefore, the conversion of air conditioning refrigerant into the ones who has smaller greenhouse effect, even if it is dissipated into the atmosphere, became our responsibility.

Nevertheless, in case of air conditioning refrigerant, it would be the best if there is a refrigerant which has smaller impact on global warming, but ensures good energy efficiency and performance, and is safe; however, there is no such refrigerant which satisfies all these conditions. As a result, we have been considering the practical usage, within the safety frame-work, of R32 refrigerant which has short lifetime in the atmosphere, and has smaller effect of global warming, but is slightly flammable.

In 2004, due to the revision of air conditioner safety standards by the International Electro-safety Commission (IEC), the safety standards of air conditioners using slightly flammable refrigerant was issued. In 2010, the regulations of American Society of Heating, Refrigerating and Air-Conditioning Engineers in the United States (ANSI/ASHRAE34) was issued adopting the grades for refrigerants which are difficult to inflame due to their slow burning rates, and as a result have smaller damages in cases of fire. The burning rate of R32 is lower by 10cm / per second, and safety standardization for various usage is now being processed.

13.2 Characteristics of R32 Refrigerant

1. Chemical Characteristics

R32 is one of the refrigerants used in R410A, has almost no toxicity, and chemically stable compound formed by hydrogen, carbon and fluorine.

R32 has short lifetime of 4 to 9 years in case of being released into the atmosphere; therefore, it has smaller greenhouse gas effect but has slight inflammability because of the large proportion of hydrogen.

Chemical Characteristic Table of R32, R410A and R22.

	R32	R410A	R22
Chemical Formula	CH ₂ F ₂	CH ₂ F ₂ / CHF ₂ CF ₃	CH ₂ ClF
Composition (mixture ratio wt.%)	Single Composition	R32 / R125A (50 / 50 wt.%)	Single Composition
Boiling Point (°C)	-51.7	-51.5	-40.8
Pressure (physical) *1	3.14	3.07	1.94
Capacity (physical) *2	160	141	100
COP (physical) *3	95	91	100
Ozone Depletion Potential (ODP)	0	0	0.055
Global Warming Potential (GWP) *4	675	2090	1810
Inflammability *5	Slightly Inflammable (A2L)	Non-inflammable (A1)	Non-inflammable (A1)
Toxicity	None	None	None

*1 : Physical property of temperature condition 50°C

*2 : Relative value of temperature condition 0/50°C, providing R22=100

*3 : Te/Tc/SC/SH=5/50/3/0°C

*4 : GWP=Global Warming Potential, each figure is based on “4th IPCC4 Report”

*5 : Based on ANSI / ASHRAE std. 34-2010

2. Characteristic of Pressure

As shown in Table 2, R32 does not have much difference in vapor pressure at the same refrigerant temperature comparing to R410A, but comparing to R22, it is higher at 1.6 times more. Thus, the same as in case of R410A, it is necessary to do installation and service using high-pressure tools and components.

Table 2. Saturated vapor pressure comparison table

(Unit: MPa)

Temperature	Refrigerant		
	R32	R410A	R22
-20	0.30	0.30	0.14
0	0.71	0.70	0.40
20	1.37	1.35	0.81
40	2.38	2.32	1.43
60	3.84	3.73	2.33
65	4.29	4.17	2.60

Reference : Thermal properties table of Japan Society of Refrigerating and Air Conditioning Engineers (60, 65°C)
NIST REFPROP V8.0 (-20 ~ 40°C)

13.3 Refrigerant piping installation • Tools used in services

13.3.1 Required Tools

R32 refrigerant air conditioners use the common parts as R410A air conditioners for two-way valves and three-way valves (diameters of service ports); thus, they maintain commonality in the maintenance of the compressive strength, the size of pipe flaring, and the size of flare nuts as R410A. Therefore, for refrigerant pipe installation and services, you can use tools for R410A.

However, mixing of refrigerants is not allowed, so that you have to separate the cylinders for the recovery of refrigerants.

Tools used for installation • relocation • replacement of air conditioning units

Works	R32	R410A	R22
Flaring	Flare tools for R410A (clutch type)		Flare tools for R22 (clutch type)
Connection of pipes	Torque wrench (diameter 1/4 3/8)		
	Torque wrench (diameter 1/2 5/8) *1		Toque wrench (diameter 1/2 5/8)
Manifold gauge charging hose	R32 & R410A Common (As at November 2013)		R22 Only
Air purging	Vacuum pump + Reducer / expander		Vacuum pump
Gas leakage test	Detection liquid or soup water, HFC detector		

*1. Nut diameters of 1/2 5/8, the size of torque wrench common with R410A

For other installation, you can use general tools such as screw drivers (+, -), metal saws, electric drills, long-nose pliers, hole core drills ($\varnothing 70$ or $\varnothing 65$), linen tape, levels, temperature gauges, clamp meters, electric knives, nippers, pipe cutters, reamers or scrapers, spring benders, (diameters 1/4 3/8 1/2 5/8), monkey wrenches, fixing wrenches (17 or 12 mm), feeler gauges, hexagon wrenches (4 mm), testers, megohm testers, etc.

Tools used for services

Works	R32	R410A	R22
Insertion of refrigerant	Digital scale for refrigerant charging, refrigerant cylinders, cylinder adopters and packing *a		
Recovery of refrigerant	Refrigerant recovery devices, refrigerant cylinders, manifold gauges, charging hoses *b		

*a. Use cylinder for each refrigerant, cylinder adopter and packing.

*b. Use refrigerant recovery cylinder separately for each refrigerant (**no mixture of refrigerant allowed**). Please be aware that there are some refrigerant collection devices which do not have self-certification.

13.3.2 Tools for R32 (common with R410A)

1. Flare gauges

Use flare gauges when you perform flaring with flare tools (crutch type). Flare gauges are used to set the pipe ends at 0.5 ~ 1.5 mm from clump bars of flare tools.

Flare gauges



2. Flare tools (clutch type)

Flare tools have larger holes of clump bars in order to set the pipe end at 0 ~ 0.5 mm, and have stronger springs inside to ensure solid flaring torques. These flare tools can be used commonly for R22.

Flare tools (clutch type)



3. Torque wrenches (diameters 1/2, 5/8)

In order to strengthen the compressive strength, the diameters of wrenches change depending on the flare nut sizes.

Torque wrenches

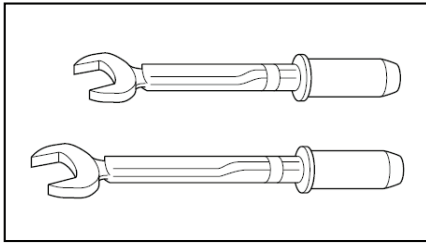

Differences in torque wrenches

	R32 (common R410A)	R22
1/2 (diameter x torque)	26 mm x 55 N•m (550 kgf•m)	24 mm x 55 N•m (550 kgf•m)
5/8 (diameter x torque)	29 mm x 65 N•m (650 kgf•m)	27 mm x 65 N•m (650 kgf•m)

4. Manifold gauges

R22 gauges cannot be used because of the high pressures.

Each port of manifold has different shapes in order to prevent inserting wrong refrigerant.

*However, the port shape for R410A and R32 is the same; therefore, attention need to be paid not to insert wrong refrigerant.

Differences in high/low pressure gauges

	R32 (common R410A)	R22
High pressure gauges (red)	-0.1 ~ 5.3 MPa -76 cmHg ~ 53 kgf / cm ²	-76 cmHg ~ 35 kgf / cm ²
Low pressure gauges (blue)	-0.1 ~ 3.8 MPa -76 cmHg ~ 38 kgf / cm ²	-76 cmHg ~ 17 kgf / cm ²

Difference in manifold port sizes

	R32 (common R410A)	R22
Port sizes	1/2 UNF20	7/16 UNF20

5. Charging hoses

The pressure resistance of charge hoses is increased. At the same time, the material is changed to HFC resistant, and the size of each manifold adopter is changed, as the port size of manifold gauge itself. Further, some hoses are with anti-gas pressure backflow valves placed near the adopters. (hoses with the valves recommended)

Manifold gauges / Charging hoses

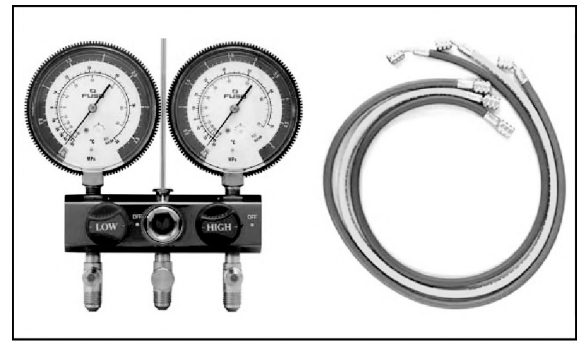

Differences in charging hoses

		R32 (common R410A)	R22
Pressure Resistance	Normal operation pressure	5.1 MPa (52 kgf / cm ²)	3.4 MPa (35 kgf / cm ²)
	Burst pressure	27.4 MPa (280 kgf / cm ²)	17.2 MPa (175 kgf / cm ²)
Material		HNBR rubber Internal nylon coating	NBR rubber

6. Vacuum pump and Vacuum pump adopter

When using a vacuum pump, it is necessary to set a solenoid valve in order to prevent backflow of vacuum pump oil into the charge hoses, and use a vacuum pump with oil backflow prevention function, or use the vacuum pump with vacuum pump adopter.

If vacuum pump oil (mineral oil-based) mixes with R410A (R32), it may cause damage to the machine.

Vacuum pump

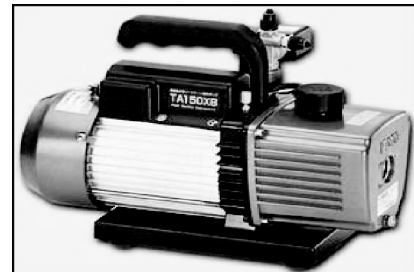

Vacuum pump adopter



7. HFC refrigerant_Electric gas leakage tester
R32 refrigerant is often used for other mixed refrigerant (R410A, R404A, R407C etc.). Therefore, the usage of existing HFC detectors is possible, but in order to detect more accurately, we recommend to use detectors specially set and adjusted for R32 detection.

HFC refrigerant_Electric gas leakage tester



8. Digital scale for refrigerant charging
R32 and R410A have high pressure level and their evaporation speed is high. Thus, if you recover the refrigerant by cylinder charging method, the refrigerant evaporates within the weighing scale glass, which makes reading the scale difficult, rather than liquidating the refrigerant into the cylinder. (Charging cylinders for R22 have different pressure resistance, scale, connection port size; therefore, they are not usable) At the same time, the digital scale for refrigerant charging is strengthened by receiving the weight of the refrigerant cylinders with four pillars at the corners. The connection ports of charging hoses have two separate ports for R22 (7/16 UNF20) and R32/R410A (1/2 UNF20) therefore, they can be used for the insertion of the existing refrigerants.

Digital scale for refrigerant charging



9. Refrigerant cylinders
Refrigerant cylinders for R410A are painted in pink, and the ones for R32 are painted in other colors that might subject to change according to the international standards. R32 is a single refrigerant, so that both liquid and gas insertion are possible. Additional charging is also possible. (R410A is a mixed refrigerant, so only liquid insertion is possible)

Refrigerant cylinders



10. Connection ports of refrigerant cylinders and packing
Charging ports which fit to the charging hose connection port size (1/2 UNF20) is needed. At the same time, the packing has to be of HFC resistant materials.

Connection ports and packing



11. Tools used for refrigerant piping installations and services

	Tools for R410A	Common with R32	Possibility of usage for R22
1.	Pipe cutters, reamers or scrapers	○	○
2.	Flare tools (clutch type)	○	○
3.	Torque wrench (1/4, 3/8)	○	○
4.	Torque wrench (1/2, 5/8)	○	✕
5.	Manifold gauges · charging hoses	○	✕
6.	Vacuum pumps, vacuum pump adopters	○ Connection 5/16	○ Connection 1/4
7.	Electric gas leakage testers for HFC *1	○	△
8.	Digital scale for refrigerant charging	○	○
9.	HCF recovery devices (connection port 5/16) *2	○ Connection 5/16	○ Connection 1/4
10.	Refrigerant cylinders (pressure resistant: FC3)	Same specs ✕	✕
11.	Refrigerant cylinders (pink)	Other (colors that might subject to change according to the international standards).	✕
12.	Refrigerant cylinder connection ports and packing	○	✕
13.	Allen wrench (4 mm) Electric knives	○	○
*1	Those testers only for HCFC22 (R22), but not for HCF32 (R32) and HCF410A (R410A) cannot be for common use.		
*2	Recovery devices which are self-certified for each HCF type can be used.		
	<p>[Knowledge for the common usage of tools for R410A & R32]</p> <ul style="list-style-type: none"> • R410A and R32 machines use different compressor oils. • If unregulated compressor oil gets mixed into, it may cause damage to the machine function. • Careful pump down will ensure the recovery of compressor oil, and it will minimize the remaining amount of the oil in the manifold gauge and charging hose. • If you only perform the recovery of refrigerant and not be able to perform pump down, <u>you have to dispose the compressor oil in the charging hose.</u> 		
	<p>[Precaution of repairing refrigerant cycle]</p> <ul style="list-style-type: none"> • In the brazing, open 2-way and 3-way valves, and make sure the refrigerant is completely recovered back and not remaining the system. • When repairing outside, make sure no refrigerant is in the air, ensure good air flow, and perform the brazing. 		
	<p>[Inserting wrong refrigerant]</p> <ul style="list-style-type: none"> • It may cause "not cooling" and "not heating" customer claims because each component (expansion valve, compressor, PCB) of the refrigeration cycle is specially adjusted for R32. • At the same time, it is not subject to product warranty, if wrong refrigerant was inserted into the system. 		

13.4 New installation, Relocation, Repairing of Refrigerant Cycle System The Procedures

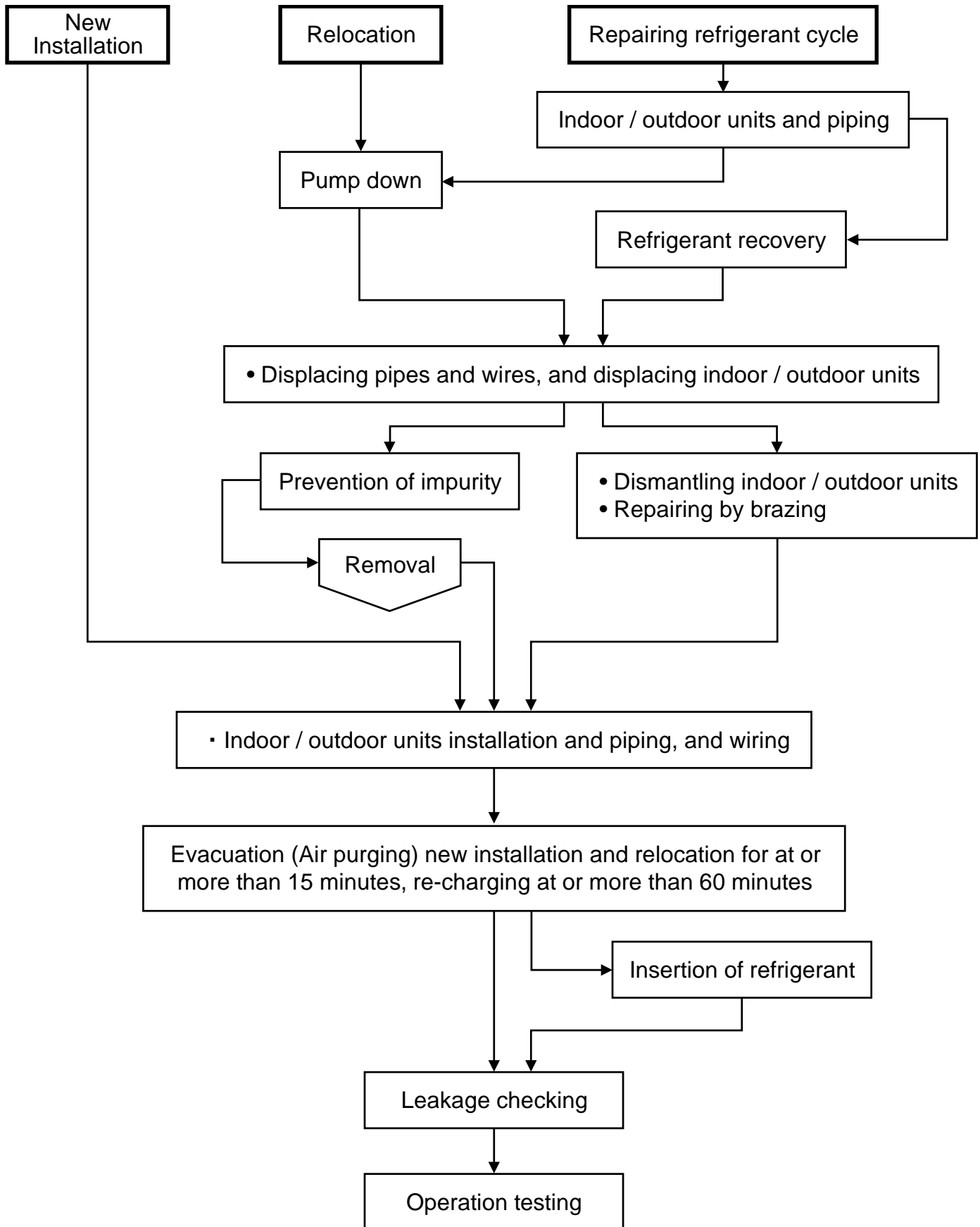

13.5 Piping installation of R32

13.5.1 Pipe materials used and flaring

Copper pipes are used for refrigerant piping. Pipes which comply with JIS Regulations need to be used. Room air conditioners which use R410A and R32 have higher pressure; thus, using pipes which comply with the Regulations is important.

The pipe thickness is regulated by revised JIS B 8607 "Flaring and brazing fittings for refrigerant" and the pipe thickness for R410A, R32 is shown in the table.

Pipe thickness

O and OL materials		Thickness (mm)		
Diameter	Diameter (mm)	R410A	R32	R22
1/4	6.35	0.80		
3/8	9.52	0.80		
1/2	12.70	0.80		
5/8	15.88	1.00		

Caution

- For connection piping, use copper phosphate seamless pipes (1220T) as regulated in "JIS H 3300" and the pipe thickness is 0.8 mm.
- In the market, there are some pipes of 0.7 mm thickness, but do not use these pipes (0.8 mm thickness has to be strictly followed).
- It is recommended to use pipes whose adhesion amount of oil is at or less than 40 mg / 10 m. At the same time, do not use pipes with dent, de-shape, and color change (especially inside).

13.5.2 Processing and connection of pipes

For refrigerant pipe installation, be aware of moisture and dirt do not get into the pipes, and make sure of no refrigerant leakage.

◎ The procedure of flaring and precautions

- Cutting of pipes : use pipe cutter and cut the pipe slowly not to de-shape the pipe.
- Removal of burrs on the edge of pipe (reamer or scraper)
If the condition of pipe edge after the deburring is no good or if burrs attaches on the flaring, it may cause refrigerant leakage. Turn the pipe end down and perform deburring carefully.
- Insert the flare nut (use the nut which is a part of the CZ parts)
- Flaring

Ensure the cleanliness of clump bar and pipe, and perform flaring carefully.

Use the existing flare tools or flare tools for R410A. Be aware that the sizes and dimensions of flaring is different in each flaring tool. If you use the existing flaring tools, use flaring gauge to measure the length of the flaring part.

Piping size (mm)	Dimensions "a" (mm) R22			Dimensions "a" (mm) R410A/R32		
	Flare tools		Flare tools for R410A	Flare tools		Flare tools for R410A
	Clutch type	Wing nut type	Clutch type	Clutch type	Wing nut type	Clutch type
6.35 (1/4")	0.5 ~ 1.0	1.0 ~ 1.5	0 ~ 0.5	1.0 ~ 1.5	1.5 ~ 2.0	0 ~ 0.5
9.52 (3/8")	0.5 ~ 1.0	1.0 ~ 1.5	0 ~ 0.5	1.0 ~ 1.5	1.5 ~ 2.0	0 ~ 0.5
12.70 (1/2")	0.5 ~ 1.0	1.5 ~ 2.0	0 ~ 0.5	1.0 ~ 1.5	2.0 ~ 2.5	0 ~ 0.5
15.88 (5/8")	0.5 ~ 1.0	1.5 ~ 2.0	0 ~ 0.5	1.0 ~ 1.5	2.0 ~ 2.5	0 ~ 0.5

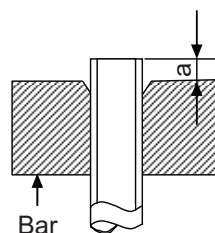

Nut outer diameter (mm)	
R22	R410A
	R32
17	17
22	22
24	26
27	29

13.6 Installation, Relocation, and Service

13.6.1 Air purge and gas leak test for new installation (using new refrigerant pipes) using vacuum pump

(From the point of view of global environment protection, do not release CFCs into the atmosphere during installation work)

1. Connect the charging hose of manifold gauge to the service port of 3-way valve (pushing insect pin).
2. Fully open the handle Lo of manifold gauge and operate vacuum pump.
(If the needle of the low-pressure gauge reaches the vacuum immediately, check 1 procedure again)
3. Perform vacuuming 15 minutes or more, and make sure low pressure gauge reaches to -0.1 MPa (-76cmHg).
When the vacuuming completes, fully open the handle Lo of manifold gauge and stop the operation of vacuum pump, and leave it for 1 ~ 2 minutes. Then, remove the connection side of the charging hose of vacuum pump adaptor after checking the needle of manifold gauge does not turn back.
4. Open the stem of 2-way valve to 90° in anti-clock wise, and close the 2-way valve after 10 seconds, and perform gas leakage test.
5. Remove the charge hose from the service port of 3-way valve, and open the stems of 2-way and 3-way valves (open the valves to anti-clock wise carefully, do not use full strength to open)
6. Tighten the service port cap with torque wrench $18\text{ N}\cdot\text{m}$ ($1.8\text{ kgf}\cdot\text{m}$)
Tighten the caps of 2-way and 3-way valves with torque wrench $18\text{ N}\cdot\text{m}$ ($1.8\text{ kgf}\cdot\text{m}$)
7. After the tightening of each cap, check gas leakage around the cap.

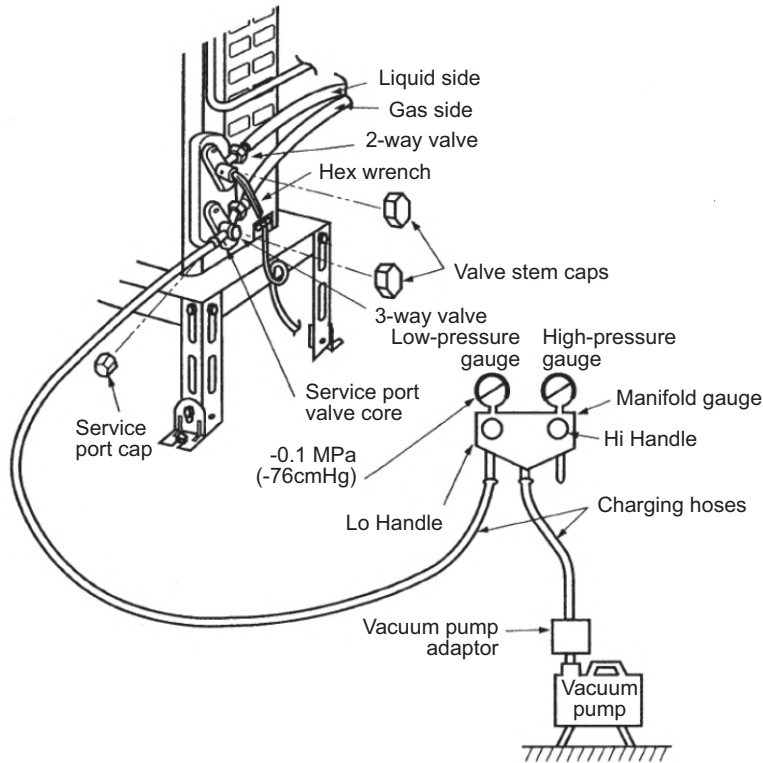

13.6.2 Process of refrigerant recovery

1. Connect the center charging hose of manifold gauge to the in-let side of recovery device.
2. Connect the valves of the discharge side of recovery device and liquid side of refrigerant cylinder with red hose (charging hose).
3. Connect the yellow float switch cable of the recovery device to the refrigerant cylinder.
4. Open the low pressure side valve of manifold gauge.
5. Slightly loosen the charging hose of in-let connecting side of recovery device and perform air purge.
6. Open the liquid valve of refrigerant cylinder and slightly loosen the charging hose in discharging side of recovery device, and perform air purge (the recovery cylinder needs slight inside pressure).
7. Insert electric plug of recovery device into electrical outlet (the fan operation starts).
8. Turn the valve 1 and 2 of recovery device to pressure equalization point.
9. After a few seconds, turn back the valve 1 and 2 to the original position.
10. Turn the switch of the recovery device to "ON". (the compressor operation starts)
11. When the low pressure of manifold gauge is close to "0", close the low pressure side valve, turn "OFF" the recovery device switch.
12. Remove the center charging hose of manifold gauge from the recovery device.

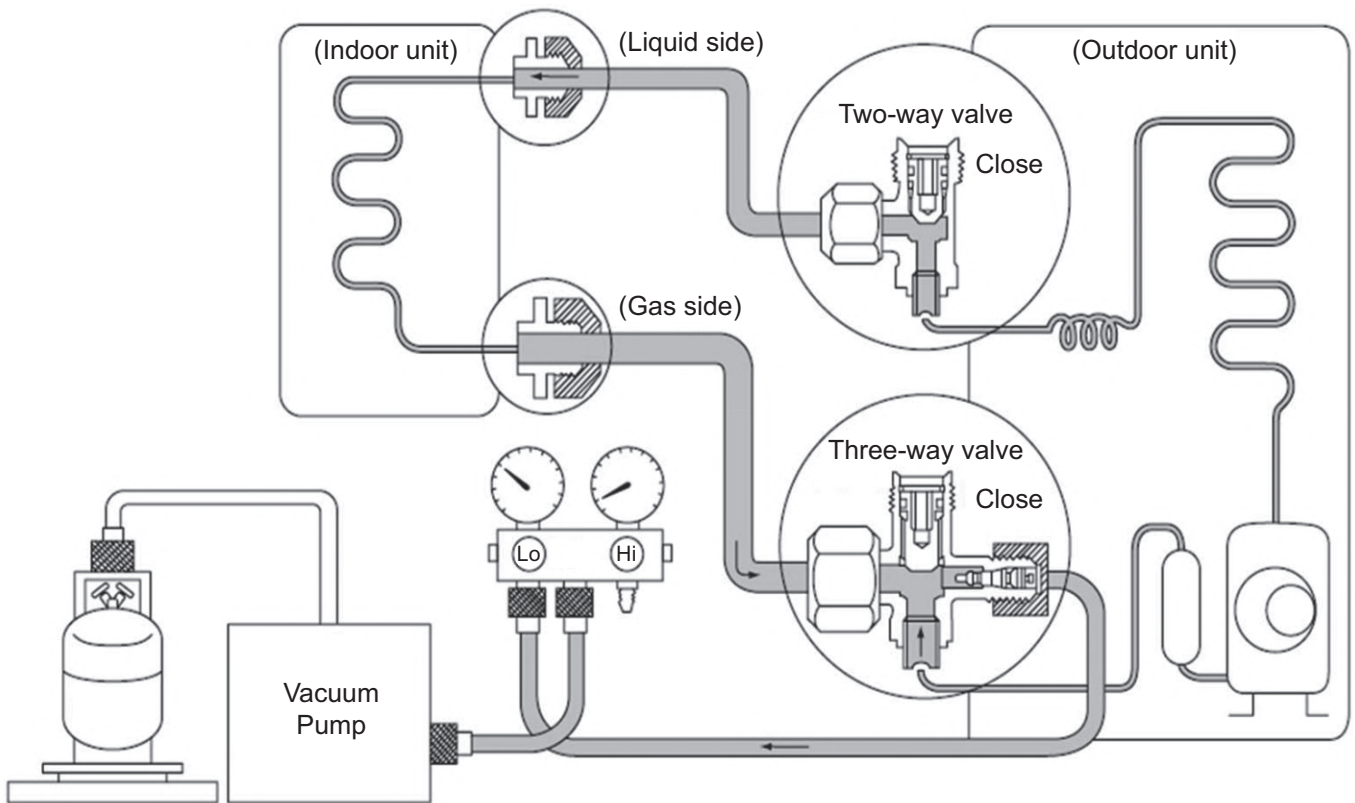

13.6.3 Relocation

1. Removing the air conditioning unit

a) Recovery of outdoor unit refrigerant by pumping down

Press “forced cooling button” (as a general rule, since 1998 the name of cooling testing button is changed, and this name is unified within the air conditioning industry), and then you are able to start cooling operation in which the room temperature is low, and you can recover the refrigerant from the outdoor unit.

1. Check the valve stems of two-way and three-way valves are open by being turned to anti-clockwise (Remove the caps, and confirm the bars are fully open. Use hexagon wrench <4 mm> to open and close the valves).
2. Press the “Emergency Operation” button of the indoor units for five seconds and release [Forced cooling operation] (for old models, press “forced cooling” button). Then, operate the air conditioning unit for about 10 minutes.
3. Turn the stem of the two-way valve to the clock-wise and close the valve.
4. After about 2 ~ 3 minutes, turn the stem of the three-way valve quickly to the clock-wise, and stop the operation.

Caution: In the pump down operation, stop the compressor before removing the refrigerant pipes.

If you do not stop the compressor operation, and if the valve is open and remove the refrigerant pipes, the air may be sucked into the system and causes extreme high temperature in the refrigerant cycle. This may result in rupture or injury, etc.

5. Attach and tighten the caps of two-way and three-way valves with torque wrench.
6. Remove the connecting pipes (liquid side and gas side).

b) Removal of indoor and outdoor units

1. Remove the connecting pipes and wires between the indoor and outdoor units.
2. Attach capping flare nuts on the edges of the pipes, connecting the indoor and outdoor units, in order to prevent dust and moisture get into the pipes.
3. Remove the indoor and outdoor units.

2. Unit installation

Use new refrigerant pipes for the installation, and perform air purging using vacuum pump and gas leakage testing stated in 14.5.1.

13.6.4 Replacement of air conditioning units and evacuation (when re-using the existing pipes)

When replacing the air conditioning units, you might use the existing pipes, but it is recommended to perform flaring again. In case of unit replacement, even if the unit is new refrigerant air conditioner, if the refrigerant oil is different, it may cause problem. Further, when re-using the existing refrigerant pipes, it is recommended to evacuate the pipes as much as possible, due to the reason that much refrigerant oil may be attached on the surface of the pipes. If the pipes are used without evacuation, the remaining refrigerant oil may cause under-performance and abnormal refrigerant cycle caused by non-compatibility of those oils.

13.6.5 Inter-changeability of refrigerant

Do not operate air conditioning units inserting wrong (or mixed) refrigerant (R22, R410A, R32). It may cause malfunction of the units, and at the same time, may cause serious incident such as rupture of the refrigerant cycle.

13.6.6 Re-insertion of refrigerant in service

When re-insertion is needed, follow the procedures to ensure the insertion of new refrigerant at correct amount.

1. Attach charging hose (blue) to the service port of the outdoor unit.
2. Attach charging hose (red) to the vacuum pump. Fully open the 2-way and 3-way valves.
3. Place the refrigerant cylinder on the digital scale for refrigerant charging and connect the charge hose (yellow) to the connection port of the vacuum pump and the digital scale. Leave the cylinder valve fully open.
4. Fully open the handles Lo and Hi of the manifold gauge, and switch on the vacuum pump, and then perform evacuation for at or more than one hour.
5. Confirm the compound gauge of -0.1 MPa (-76cmHg) and fully open the handles of Lo and Hi, and switch off the vacuum pump. Leave it for about 1 ~ 2 minutes and confirm the needle of the compound gauge does not turn back.

Refer to the picture below to follow the procedures below.

6. Remove the charging hose (red) of the manifold gauge from the vacuum pump adaptor.
7. After adjusting the digital scale to zero, open the cylinder valve and the valve Lo of the manifold gauge, and insert the refrigerant.
8. If it is not possible to insert the refrigerant at regulated amount at once, operate the cooling mode and gradually insert the refrigerant (recommended amount approx. 150 g / 1 time)
*Do not insert much refrigerant at once.
9. Close the open/close valve and insert the refrigerant in the charging hose to the outdoor unit.
*Perform this procedure during operating cooling operation. Close the stem of the two-way valve, and when the pressure of the manifold gauge becomes zero (0), quickly remove the charging hose (blue). Immediately open the 2-way valve, and stop the cooling operation.
10. Final checking ••• Confirm the 2-way and 3-way valves are fully open.
Attach the caps of the service port and control valve, and then check the gas leakage around the caps.

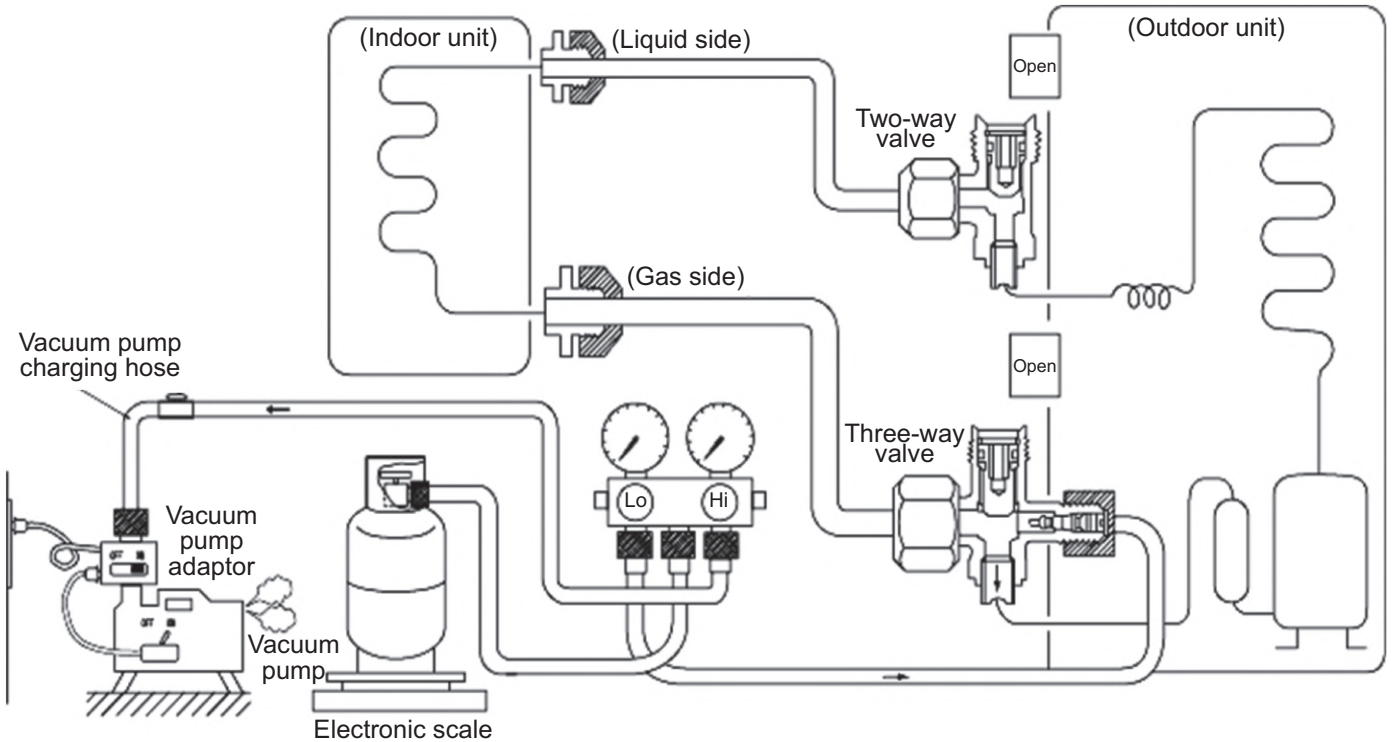

13.7 Repairing of refrigerant cycle / Brazing point

13.7.1 Preparation for repairing of refrigerant cycle / brazing

Brazing which is a technique needed for repairing refrigerant cycle requires advanced technique and experience, and this brazing procedure can only be performed by the workers who completed "Gas Welding Skill Training" regulated by the Occupational Safety and Health Act, and went through the training programs of refrigerant operations. Dismantling and re-connecting (assembling) refrigerant system requires working space, and the space has to ensure good air flow and fire prevention (water bucket and fire extinguisher). Moreover, the worker has to ensure the wearing of goggles, gloves, safety shoes, and long sleeve shirts, and be aware of work safety and attempt to prevent secondary defect (quality assurance of products). For brazing the indoor / outdoor unit structural components (heat exchangers, compressors, expansion valves, four-way valve blocks), after the recovery of all refrigerant, confirm that no refrigerant remains in the system, and fully open the 2-way and 3-way valves. When the brazing is conducted outside, check and make sure no refrigerant is contained in the air (be careful with vaporized refrigerant). Furthermore, protect the compressor terminal with metal plates, and heat but use wet clothes to cool down (releasing the heat) the expansion valves, and four way valves (prevent destruction of parts). In brazing, it is important to pour the brazing material without melting the base metal based on capillary action principle. In case of holes and oxidizing caused by overheating, do not perform re-brazing or alteration but replace the parts.

13.7.2 Adjustment of vacuum pump pressure

1. Cylinder with adjustment handle

1. Check and confirm the adjustment handle of the 1st pressure adjuster is loosen (anticlockwise). If cylinder valve is opened when the 1st gauge pressure adjust handle is closed, the 2nd gauge might get broken.

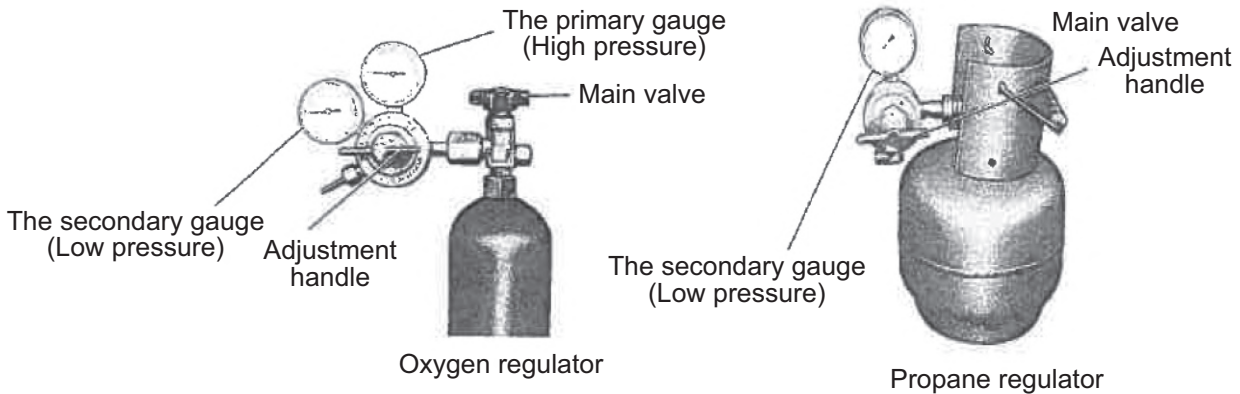

2. Open the cylinder valve, and check the remaining amount with the first side pressure gauge.
3. Check the pressure of 2nd gauge and turn the adjustment handle to clock-wise direction to adjust the pressure.
 - ◎ Oxygen 2nd side gauge pressure 0.5 MPa (5.0 kgf / cm²)
 - ◎ Propane 2nd side gauge pressure 0.05 MPa (0.5 kgf / cm²)

2. Cylinder without adjustment valve
 2nd side gauge pressure is adjusted by the adjuster.
 Check the both side valves of the torch and open the cylinder valve to check the remaining refrigerant in the cylinder.
 Caution: Do not attach oil component on the connection port of the adjuster.
 Especially, use an oxygen cylinder adjuster which is no oil substance type. Do not dismantle or repair the adjuster and pressure gauge.

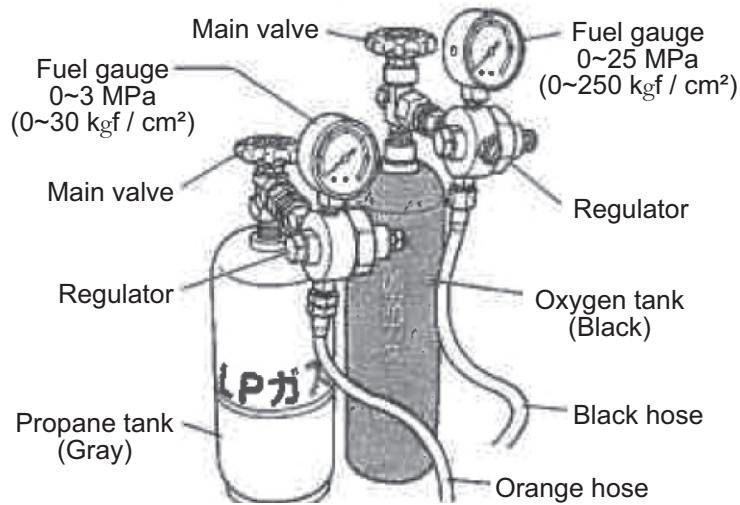

13.7.3 Checking of gas provision

Checking there is no fire around the torch, and then confirm the provision of gas.

1. Slightly open the “propane valve” of the torch, and make sure the gas comes out from the torch crater and then close the “propane valve”.
 2. Slightly open the “oxygen valve” of the torch and make sure the gas comes out from the torch crater and then close the “oxygen valve”.
- Check there is no gas leakage around the hose connection.

13.7.4 Adjustment of flame

1. Slightly open the “propane valve” of the torch and lit with spark lighter.
 This moment, the flame is only by propane and the color is red.
2. Gradually open the “oxygen valve” of the torch to mix oxygen, and adjust the amount of propane and oxygen with the valve to make the flame suitable for brazing work.
 If the white core flame splits into two, the torch crater might be clogged. In this case, remove the crater from the torch and check.

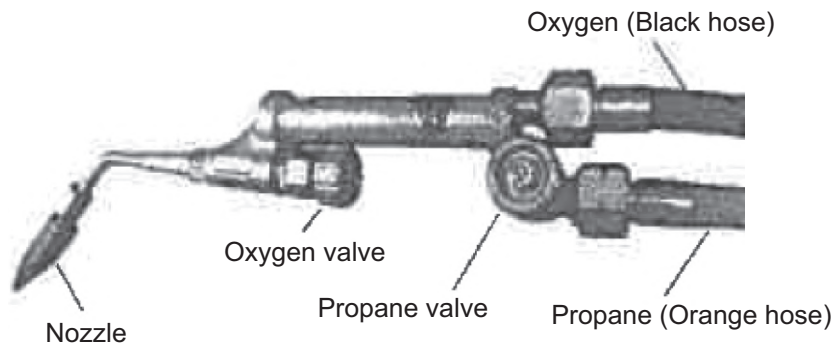

13.7.5 Types of flame

Types of flame change based on the proportion of propane and oxygen.

[Neutral Flame]

Perform brazing with this flame

(This is a flame when oxygen and propane are mixed at proper proportion, and has lesser effect on the brazed metals)

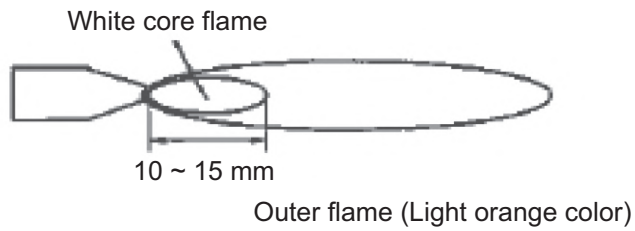

[Carbide Flame]

When propane is excessive, the flame has white color flame in between the white core flame and outer flame. (This is due to the lack of oxygen and the proportion of unburned propane is excessive. The black carbon created during the brazing work may contaminate the surface of the brazed metal).

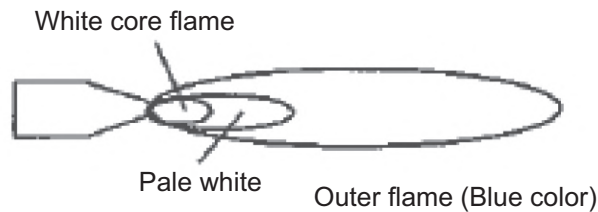

[Oxidizing Flame]

Oxygen is more compared to the neutral flame. Although the flame size is small, this has the highest flame heat. However, due to the excessive oxygen contained in the flame, the brazing point gets oxidized. (This flame may cause holes, due to the high heat. The pipe may get melt)

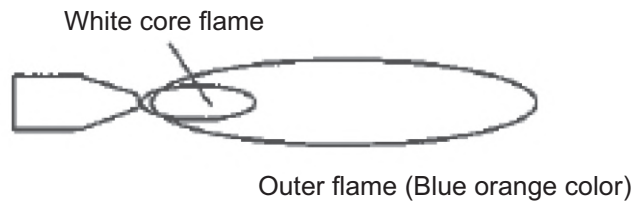

13.7.6 Closing the flame

[In case of short break]

1. Close the "propane valve" of the torch.
2. Close the "oxygen valve" of the torch.

[In case of finishing work]

1. As above, close the flame following the procedure of "In case of short break".
2. Completely close the valves of oxygen and propane cylinders.
3. Release the remaining gas inside the hose by opening the "oxygen valve" and "propane valve" of the torch. Confirm the 1st and 2nd side gauge pressures of "oxygen" and "propane" cylinder pressure adopter are "zero".

13.7.7 Selection of brazing material

Use BAg brazing material (silver solder) to increase the welding performance.

Category	JIS Standard Number	Composition of ingredients (%)						Temperature (°C)			Tensile strength (Reference)		Characteristics and applications
		Ag	Cu	Zu	Cd	Ni	P	Solidus	Liquidus	Brazing temp	Kgf•cm ²	Base material	
BAg	BAg • 1A	49.0 ~ 51.0	14.5 ~ 16.5	14.5 ~ 18.5	17.0 ~ 19.0	—	—	approx. 625	approx. 635	635 ~ 760	45.5	S20C	Liquidity is good at low temperature, it is preferable to a small junction of the gap in the universal form.
	BAg • 1	44.0 ~ 56.0	14.0 ~ 16.0	14.0 ~ 18.0	23.0 ~ 25.0	—	—	approx. 605	approx. 620	620 ~ 760	45.5	S20C	It has similar performance to the BAg • 1A, and suitable for every base material except the light weight metal.
	BAg • 2	34.0 ~ 36.0	25.0 ~ 27.0	19.0 ~ 23.0	17.0 ~ 19.0	—	—	approx. 605	approx. 700	700 ~ 845	45.5	S20C	It is a brazing filler metal in universal form, suitable for a slightly larger gap junction.
	BAg • 3	48.0 ~ 51.0	14.5 ~ 16.5	13.5 ~ 17.5	15.0 ~ 17.0	2.5 ~ 3.5	—	approx. 630	approx. 690	690 ~ 815	35 ~ 70	SS ~ SUS	It has good corrosion resistance in stainless steel-based brazing, suitable for brazing tungsten carbide, aluminum bronze and copper.
BCuP	BCuP-2	—	remain	—	—	—	6.8 ~ 7.5	approx. 710	approx. 785	690 ~ 815	21 ~ 24.5	Cu	Good liquidity, suitable for brazing copper tube.
	BCuP-3	4.8 ~ 5.2	remain	—	—	—	5.8 ~ 6.7	approx. 645	approx. 815	720 ~ 815	21 ~ 24.5	Cu	Suitable for brazing when the joint spacing is not constant
	BCuP-5	14.5 ~ 15.5	remain	—	—	—	4.8 ~ 5.3	approx. 645	approx. 800	705 ~ 815	21 ~ 24.5	Cu	When brazing of copper and copper, it is used without a flux, but not possible for brazing basic materials

Caution

BCuP (phosphorus copper wax) is easy to react with sulfur, and makes a brittle compound water soluble, and causes gas leakage. In hot spring areas, use other brazing materials or paint the surface for protection.

13.7.8 Need of flux

Use flux to protect the base materials.

1. Remove impurity and oxide film on the metal base, and improve the flow of the brazing material.
2. Prevent oxidation of the metal surface in brazing.
3. Reduce the surface tension of the brazing material.

13.7.9 Need of nitrogen gas

In order to prevent oxidation in the pipe, perform the brazing operation in nitrogen gas flow. Flow rate 0.05 m³ / h, or pressure reducing valve at 0.02 MPa (0.2kgf / cm²) below.

13.7.10 Checking of brazing (insert) points

1. No impurity on the brazing point
If dirt or oil is attached on the brazing point, the brazing filler metal does not reach to junction, and it may cause poor welding.

2. Adequate gap space in the brazing point
The advantage of capillary current situation is used in brazing. If the gap space is too large, this phenomenon may not occur and it may cause poor welding because brazing filler metal does not flow to join the front part.

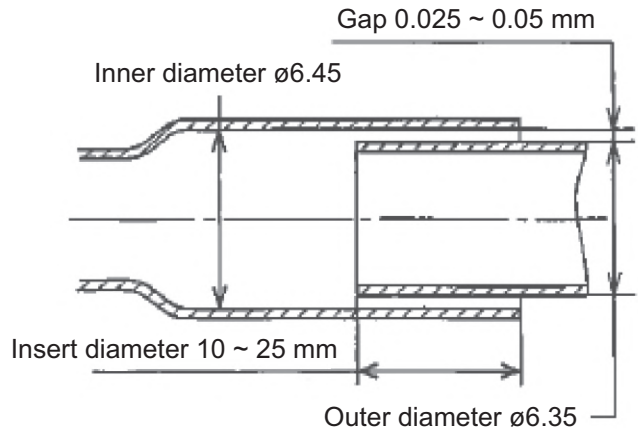

3. Appropriate size for insertion
The guideline for pipe insertion dimensions is to three times the diameter of the base material, but you need to decide the insertion size in consideration of the clogging of the brazing material. Generally, for thin pipes, you need to increase the insert size, and for thick pipe vice versa.

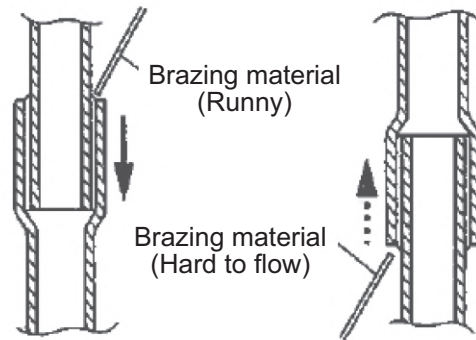

4. Brazing material to flow from top to bottom
Brazing filler metal will easily flow to the connecting portion by capillary action. Further, by bending the brazing portion of [dryer side] of the capillary tube at 15 mm from the tube top to the angle of about 120°, you can prevent the damage of dryer inside and the clogging of brazing material caused by the excessive insertion of capillary tube.

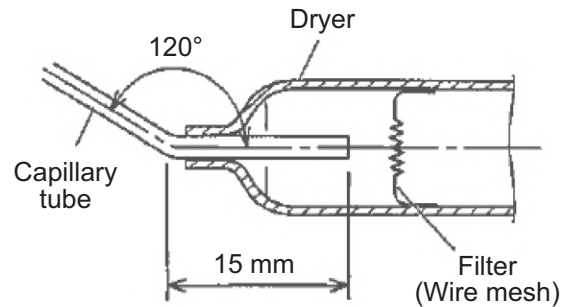

13.7.11 Brazing and heating

1. Place the flame to a pipe which has more heat capacity in order to let the brazing material melt by the pipe heat. Heat the pipe up to the melting temperature of the brazing material, but when it is overheating, assess the temperature by pipe color in order not to melt the pipe.

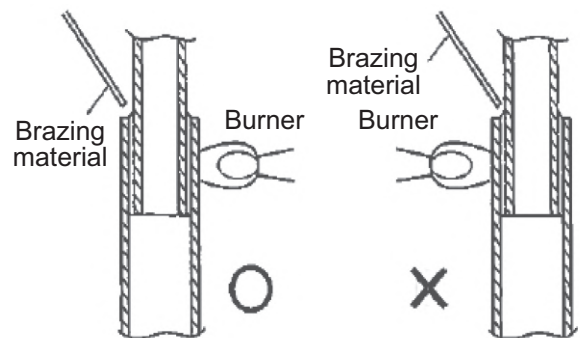

The pre-heating is to heat the base material until the melting temperature, and requires certain training to distinguish the color of the heated base material in order not to melt the material.

The color and temperature of copper tube

- Becoming red color •••••••• 480°C
- Dull red •••••••• 650°C
- Cherish red •••••••• 760°C
- Brightening cherish red •••••••• 870°C

(Reference)

Melting temperature of copper •••••••• Approx. 1083°C

Maximum temperature obtained in propane and oxygen •••••••• Approx. 1083°C

The important point is to heat the bonding part uniformly within a short period of time until reaching to the brazing temperature in the following manner.

2. Apply the flame on to the side with better heat transmission. If the pipe thickness is consistent, by heating like 30% iron and 70% copper, the copper pipe inside reaches to brazing temperature.
Iron pipes have low heat transmission and only the part the flame is applied get high temperature, and this causes oxidization of the pipe. The flow of the brazing filler is affected negatively.
3. Apply the flame on to the side of larger heat capacity.
When brazing a thin tubes such as capillary tube and dryer, etc., caution has to be taken to apply the flame to the dryer side (thick pipe side), in order to prevent burn out by the heat.
4. When brazing the compressor connection pipes (suction and discharge), remove the sound insulation plate and the fan, and place the compressor stand vertically (to prevent the leakage of compressor refrigerating machine oil), and apply the flame from the compressor body side.

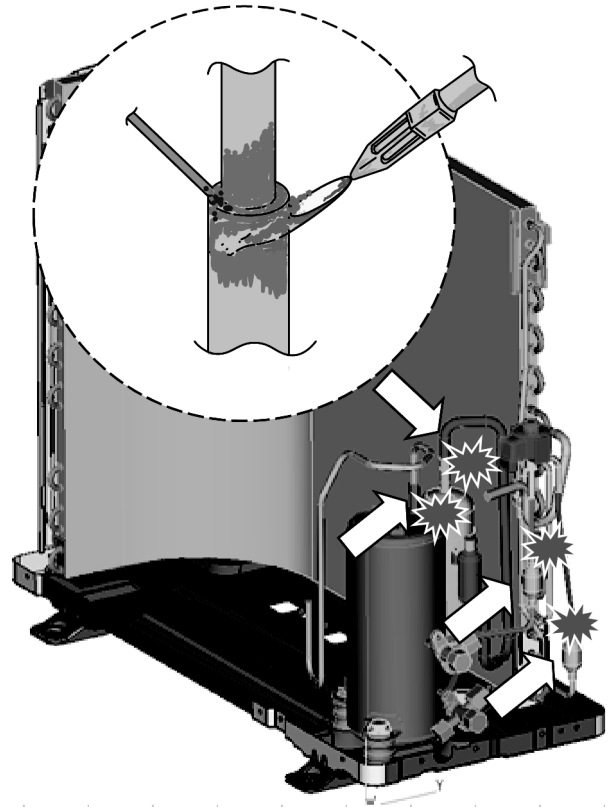

13.7.12 Terminologies of brazing

Pin holes → Small holes are generated on the surface of the brazing metal.

Wet temperature → Liquidus temperature at which the brazing material starts flowing out by heating, generally it is the liquidus-line temperature.

Blow holes → Hollows made by gas in the brazing material of brazing portion (gas reservoirs).

Pits → As a result of blow holes, small dents generated on the outside surface of welding.

Voids → The brazing material does not reach completely to the brazing part. It cannot be identified from outside.

13.8 <Reference> Analysis method for no error code, no cooling / no warming

13.8.1 Preparation for appropriate diagnosis

In order to obtain appropriate operation characteristics, minimum 15 minutes or more operation time [testing operation (rated operation)] is required.

1. Method of rated operation (rated operation)

For the models which have two buttons of "emergency operation and forced cooling operation", press forced cooling button once. For the models which have only emergency operation button, press the button once for 5 seconds and when hear "beep" sound, release the button. Then, cooling operation starts.

2. Checking the mal-functions of indoor / outdoor units

- 1) Any obstacles against heat release and air suction? (short circuit)
(Forget to remove the outdoor unit cover or fallen leaves blocking the outdoor unit)
- 2) Are the indoor unit air filters clean? (obstructing heat suction)
- 3) Is the setting temperature on the remote controller correct? (is the setting temperature set at lower/higher than the room temperature?)

13.8.2 Understanding and verification of refrigerant cycle

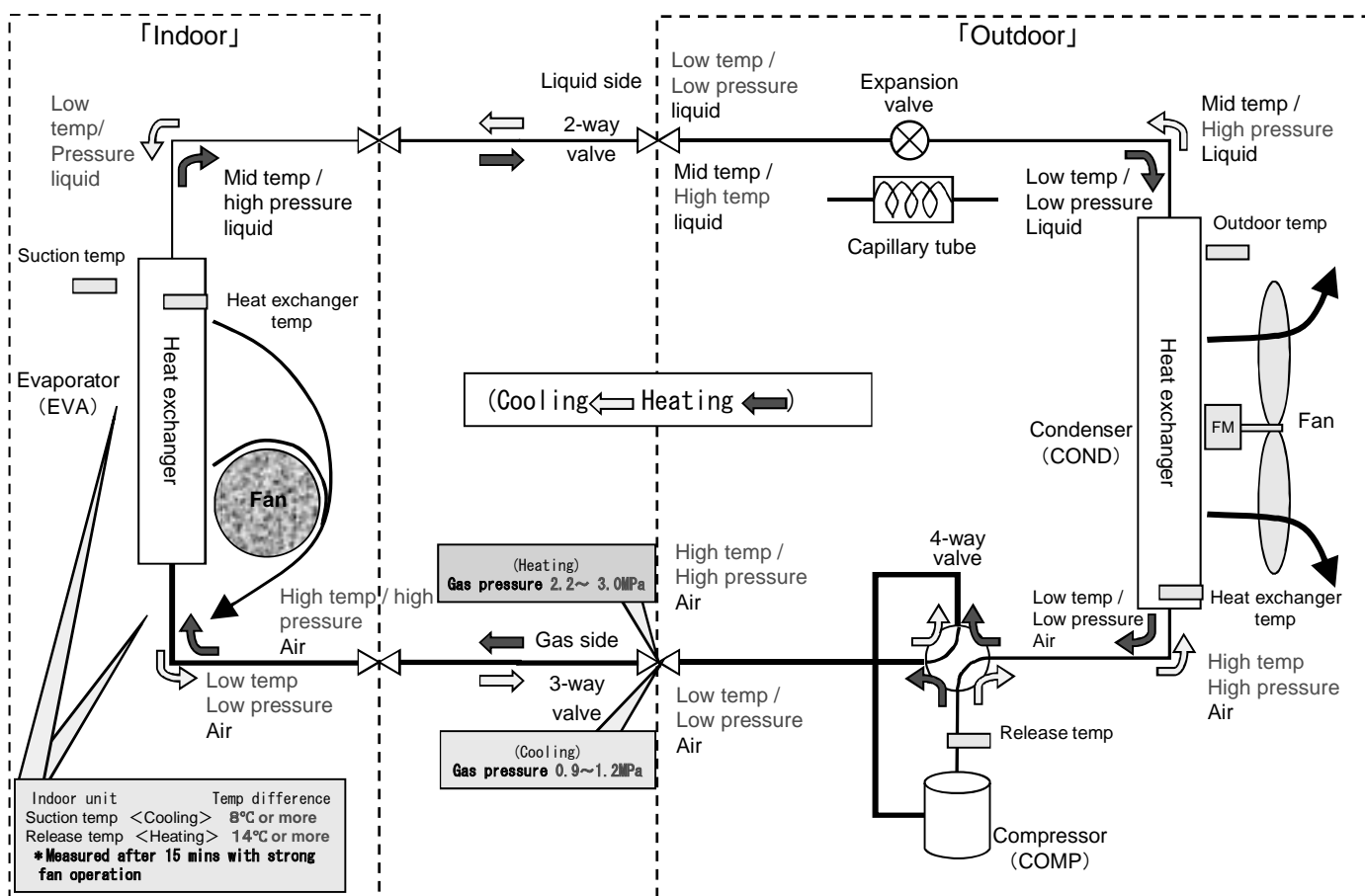

1. Measuring temperature
 - 1) Indoor unit suction temperature, release temperature, temperature difference, → Measure by thermometer
 - 2) 2-way valve pipe temperature in cooling mode is low temperature (benchmark : 5 ~ 10°C), in heating mode is medium temperature (benchmark : 25 ~ 35°C).
 - 3) 3-way valve pipe temperature in cooling mode is low temperature (benchmark : 7 ~ 15°C) in heating mode is high temperature (benchmark : 38 ~ 50°C).
2. Measuring electric current
 - Measuring electric current in operation → check by clamp meter (refer to table of technical characteristic guideline)
3. Measuring pressure
 - Measuring gas pressure → check the pressure by manifold gauge (refer to table of technical characteristic guideline)
4. Any sound from the expansion valve?
(when starting the operation and the outdoor unit is turned on, the expansion valve is re-set, check if there is any edged sound or clack sound)

13.8.3 Guidance for diagnosis of refrigerant cycle

Comparison with normal operation	Cooling mode	
	High	Low
Refrigerant pressure	Excess insertion of refrigerant	Clogged capillary, expansion valve malfunction
	Heat releasing obstruction	Clog by moisture
	Dirty condenser, attachment of impurity	Lack of refrigerant gas
	Compressor malfunction	
Operation electric current	Excess insertion of refrigerant	Lack of refrigerant gas
	Heat releasing obstruction	Compressor malfunction
	Dirty condenser, impurity	Mixture of air
		(Insufficient evacuation)
2-way valve temperature	Excess insertion of refrigerant	Clogged capillary, expansion valve malfunction
	Compressor malfunction	Lack of refrigerant gas
3-way valve temperature	Lack of refrigerant gas • Compressor malfunction	Excess insertion of refrigerant
	Clogged capillary, expansion valve malfunction	

Suction temperature & Release air temperature	Temperature difference at or less than 8°C in cooling operation ••• Causes		
	• Heat releasing obstruction	• Dirty condenser	• Attachment of impurity
	• Lack of refrigerant gas	• Excess insertion of refrigerant	
	• Mixture of air	• Mixture of moisture	
	• Clogged capillary	• Expansion valve malfunction	• Compressor malfunction

◎ Above all are based on the condition that the installation work is properly performed (no issues in indoor / outdoor pipe connections, etc.)

14. Operation Control

14.1 Basic Function

Inverter control, which equipped with a microcomputer in determining the most suitable operating mode as time passes, automatically adjusts output power for maximum comfort always. In order to achieve the suitable operating mode, the microcomputer maintains the set temperature by measuring the temperature of the environment and performing temperature shifting. The compressor at outdoor unit is operating following the frequency instructed by the microcomputer at indoor unit that judging the condition according to internal setting temperature and intake air temperature.

14.1.1 Internal Setting Temperature

Once the operation starts, remote control setting temperature will be taken as base value for temperature shifting processes. These shifting processes are depending on the air conditioner settings and the operation environment. The final shifted value will be used as internal setting temperature and it is updated continuously whenever the electrical power is supplied to the unit.

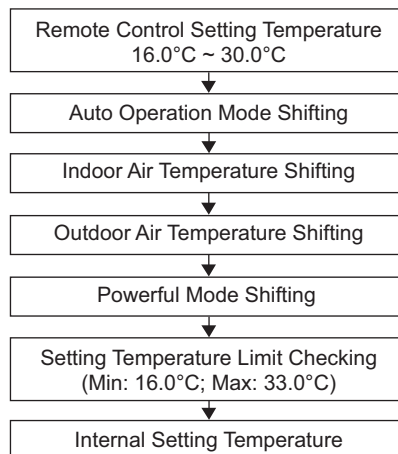

14.1.2 Cooling Operation

14.1.2.1 Thermostat control

- Compressor is OFF when Intake Air Temperature - Internal Setting Temperature < -1.5°C continue for 3 minutes.
- When compressor is OFF (Thermostat OFF) and AUTO FAN is set, the fan will stop periodically.
- Compressor is ON after waiting for 3 minutes, if the Intake Air Temperature - Internal Setting Temperature > Compressor OFF point.

14.1.3 Soft Dry Operation

14.1.3.1 Thermostat control

- Compressor is OFF when Intake Air Temperature - Internal Setting Temperature < -1.0°C continue for 3 minutes.
- When compressor is OFF (Thermostat OFF) and AUTO FAN is set, the fan will stop periodically.
- Compressor is ON after waiting for 3 minutes, if the Intake Air Temperature - Internal Setting Temperature > Compressor OFF point.

14.1.4 Heating Operation

14.1.4.1 Thermostat control

- Compressor is OFF when Intake Air Temperature - Internal Setting Temperature > +2.0°C continue for 3 minutes.
- Compressor is ON after waiting for 3 minutes, if the Intake Air Temperature - Internal Setting Temperature < Compressor OFF point.

14.1.5 Automatic Operation

- This mode can be set using remote control and the operation is decided by remote control setting temperature, remote control operation mode and indoor intake air temperature.
- During operation mode judgment, indoor fan motor (with speed of Lo-) is running for 30 seconds to detect the indoor intake air temperature.
- Every 10 minutes, the indoor temperature is judged.
- For the 1st judgment
 - If indoor intake temperature - remote control setting temperature $\geq 2.0^{\circ}\text{C}$, COOL mode is decided.
 - If $-2.0^{\circ}\text{C} \leq$ indoor intake temperature - remote control setting temperature $< 2.0^{\circ}\text{C}$, DRY mode is decided.
 - If indoor intake temperature - remote control setting temperature $< -2.0^{\circ}\text{C}$, HEAT mode is decided.

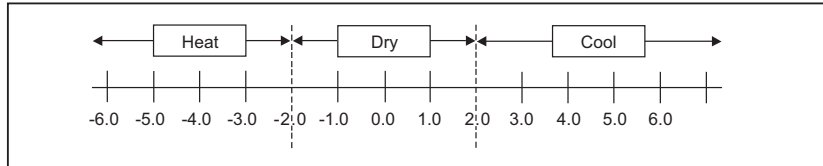

- For the 2nd judgment onwards
 - If indoor intake temperature - remote control setting temperature $\geq 4.0^{\circ}\text{C}$, if previous operate in DRY mode, then continue in DRY mode. otherwise COOL mode is decided.
 - If $-2.5^{\circ}\text{C} \leq$ indoor intake temperature - remote control setting temperature $< 4.0^{\circ}\text{C}$, maintain with previous mode.
 - If indoor intake temperature - remote control setting temperature $< -2.5^{\circ}\text{C}$, HEAT mode is decided.

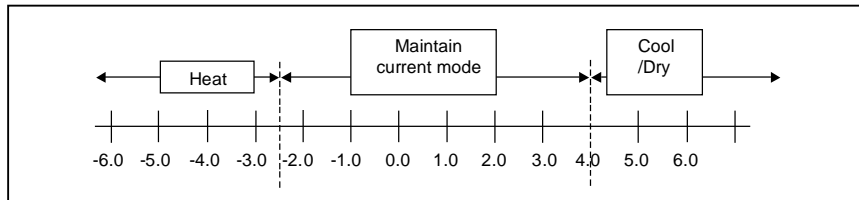

14.2 Indoor Fan Motor Operation

14.2.1 Basic Rotation Speed (rpm)

A. Basic Rotation Speed (rpm)

i. Manual Fan Speed

[Cooling, Dry]

- Fan motor's number of rotation is determined according to remote control setting.

Remote control	○	○	○	○	○
Tab	Hi	Me+	Me	Me-	Lo

[Heating]

- Fan motor's number of rotation is determined according to remote control setting.

Remote control	○	○	○	○	○
Tab	SHi	Me+	Me	Me-	Lo

ii Auto Fan Speed

[Cooling, Dry]

- According to room temperature and setting temperature, indoor fan speed is determined automatically.
- When set temperature is not achieved, the indoor fan will operate according to pattern below.

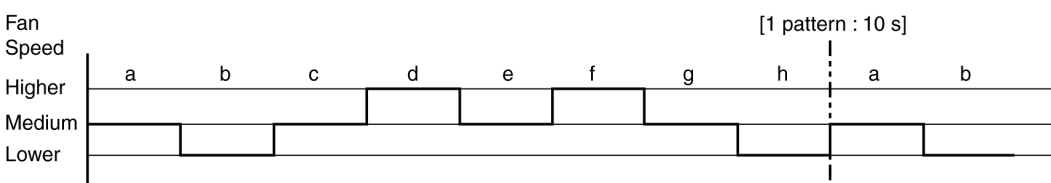

- When set temperature achieved, the indoor fan speed will be fixed. When thermostat off, the fan stop periodically.

[Heating]

- According to indoor pipe temperature, automatic heating fan speed is determined as follows.

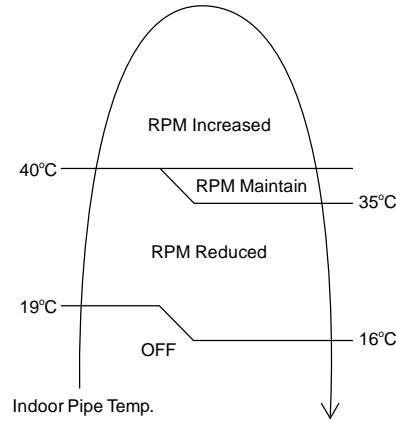

B. Feedback control

- Immediately after the fan motor started, feedback control is performed once every second.
- During fan motor on, if fan motor feedback ≥ 2550 rpm or < 50 rpm continue for 10 seconds, then fan motor error counter increase, fan motor is then stop and restart. If the fan motor counter becomes 7 times, then H19 - fan motor error is detected. Operation stops and cannot on back.

14.3 Outdoor Fan Motor Operation

- It starts when compressor starts operation and it stops 30 seconds after compressor stops operation.

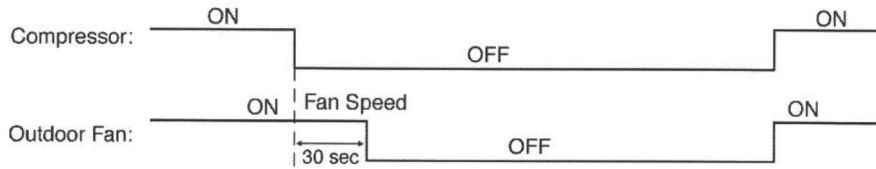

- During cooling operation, and outdoor ambient temperature is below 8°C, outdoor fan speed will be controlled according to outdoor piping temperature as following:

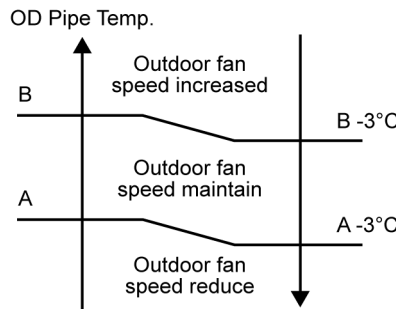

	OD Pipe Temperature
A	26°C
B	33°C

- During above condition, when indoor heat exchanger temperature is below 5°C, the outdoor fan will stop according to outdoor piping temperature as following:

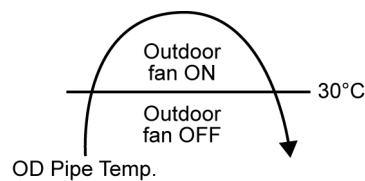

14.4 Airflow Direction

- There is one type of airflow, vertical airflow (directed by horizontal vane).
- Control of airflow direction can be automatic (angles of direction is determined by operation mode, heat exchanger temperature and intake air temperature) and manual (angles of direction can be adjusted using remote control).

14.4.1 Vertical Airflow

Operation Mode	Airflow Direction			Upper Vane Angle (°)				
				1	2	3	4	5
Heating	Auto with Heat Exchanger	A	Upward fix	20				
		B	Downward fix	58				
		C	Upward fix	20				
	Manual			20	33	45	58	70
Cooling	Auto			20 ~ 70				
	Manual			20	33	45	58	70
Soft Dry	Auto			20 ~ 70				
	Manual			20	33	45	58	70

1. Automatic vertical airflow direction can be set using remote control; the vane swings up and down within the angles as stated above. For heating mode operation, the angle of the vane depends on the indoor heat exchanger temperature as Figure 1 below. When the air conditioner is stopped using remote control, the vane will shift to close position.
2. Manual vertical airflow direction can be set using remote control; the angles of the vane are as stated above and the positions of the vane are as Figure 2 below. When the air conditioner is stopped using remote control, the vane will shift to close position.

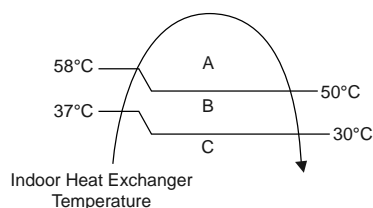

Figure 1

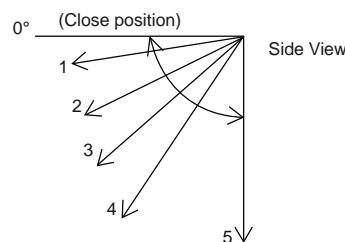

Figure 2

14.5 Quiet Operation (Cooling Mode/Cooling Area of Dry Mode)

- Purpose
 - To provide quiet cooling operation compare to normal operation.
- Control condition
 - Quiet operation start condition
 - When "QUIET" button at remote control is pressed twice. QUIET LED illuminates.
 - Quiet operation stop condition
 - When one of the following conditions is satisfied, quiet operation stops:
 - QUIET button is pressed again.
 - Stop by OFF/ON switch.
 - Timer "off" activates.
 - When quiet operation is stopped, operation is shifted to normal operation with previous setting.
 - When fan speed is changed, quiet operation is shifted to quiet operation of the new fan speed.
 - When operation mode is changed, quiet operation is shifted to quiet operation of the new mode.
 - During quiet operation, if timer "on" activates, quiet operation maintains.
 - After off, when on back, quiet operation is not memorised.
- Control contents
 - Fan speed is changed from normal setting to quiet setting of respective fan speed. Fan speed for quiet operation is reduced from setting fan speed.

14.6 Quiet Operation (Heating)

- Purpose
 - To provide quiet heating operation compare to normal operation.
- Control condition
 - Quiet operation start condition
 - When “QUIET” button at remote control is pressed. QUIET LED illuminates.
 - Quiet operation stop condition
 - When one of the following conditions is satisfied, quiet operation stops:
 - QUIET button is pressed again.
 - Stop by OFF/ON switch.
 - Timer “off” activates.
 - When quiet operation is stopped, operation is shifted to normal operation with previous setting.
 - When fan speed is changed, quiet operation is shifted to quiet operation of the new fan speed.
 - When operation mode is changed, quiet operation is shifted to quiet operation of the new mode, except fan mode only.
 - During quiet operation, if timer “on” activates, quiet operation maintains.
 - After off, when on back, quiet operation is not memorised.
- Control contents
 - Fan speed manual
 - Fan speed is changed from normal setting to quiet setting of respective fan speed.
 - Fan speed for quiet operation is reduced from setting fan speed.
 - Fan Speed Auto
 - Indoor FM RPM depends on pipe temp sensor of indoor heat exchanger.

14.7 Powerful Mode Operation

- When the powerful mode is selected, the internal setting temperature will shift lower up to 2.0°C (for Cooling/Soft Dry) or higher up to 3.5°C (for Heating) than remote control setting temperature for 20 minutes to achieve the setting temperature quickly.

14.8 Timer Control

- There are 2 sets of ON and OFF timer available to turn the unit ON or OFF at different preset time.
- If more than one timer had been set, the upcoming timer will be displayed and will activate in sequence.

14.8.1 ON Timer Control

- ON timer 1 and ON timer 2 can be set using remote control, the unit with timer set will start operate earlier than the setting time.
This is to provide a comfortable environment when reaching the set ON time.
- 60 minutes before the set time, indoor (at fan speed of Lo-) and outdoor fan motor start operate for 30 seconds to determine the indoor intake air temperature and outdoor air temperature in order to judge the operation starting time.
- From the above judgment, the decided operation will start operate earlier than the set time as shown below.

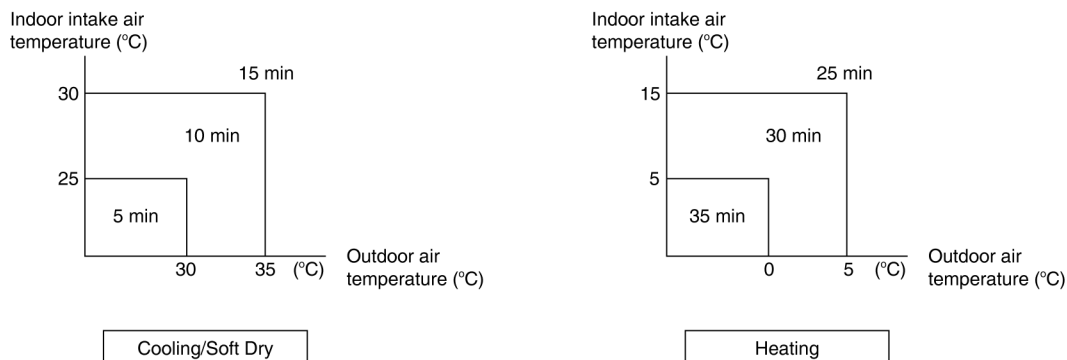

14.8.2 OFF Timer Control

OFF timer 1 and OFF timer 2 can be set using remote control, the unit with timer set will stop operate at set time.

14.9 Auto Restart Control

- When the power supply is cut off during the operation of air conditioner, the compressor will re-operate within three to four minutes (there are 10 patterns between 2 minutes 58 seconds and 3 minutes 52 seconds to be selected randomly) after power supply resumes.
- This type of control is not applicable during ON/OFF Timer setting.
- This control can be omitted by open the circuit of JP3 at indoor unit printed circuit board.

14.10 Indication Panel

LED	POWER	TIMER	POWERFUL	QUIET	AIR SWING
Color	Green	Orange	Orange	Orange	Orange
Light ON	Operation ON	Timer Setting ON	POWERFUL Mode ON	QUIET Mode ON	AIR SWING ON
Light OFF	Operation OFF	Timer Setting OFF	POWERFUL Mode OFF	QUIET Mode OFF	AIR SWING OFF

Note:

- If POWER LED is blinking, the possible operation of the unit are Hot Start, during Deice operation, operation mode judgment, or ON timer sampling.
- If Timer LED is blinking, there is an abnormality operation occurs.

14.11 Drain Pump Control Operation

Drain pump control

- This unit has built-in with drain pump.

Control content

- During COOL/DRY mode.
 - During COOL/DRY mode, drain pump starts 10 seconds after indoor fan motor starts.
 - The drain pump is always ON.
- After COOL/DRY mode, when unit turns OFF (power standby) or changes to HEAT mode.
 - The drain pump turns ON for 90 seconds immediately.
- Error judgment
 - When float switch detects ON signal continuously for 2 minutes 30 seconds, error code H21 are shown.
 - When float switch ON has operated 2 times within 20 minutes, error code H35 are shown.

14.12 HA Terminal (HAJEM-A)

- Enable digital connection from indoor unit to external devices.
- Control items:
 - 1 Start/stop input.
 - 2 Start/stop signal output.

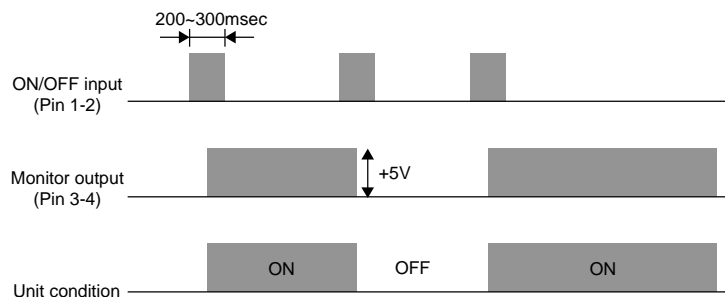

- Condition
 - 1 1-2 (Pulse input): Unit ON/OFF condition switching with a pulse signal.
(1 pulse signal: shortage status 200~300msec)
 - 2 3-4 (Static output): 5V output during the unit ON. No output at OFF.

Example of wiring:

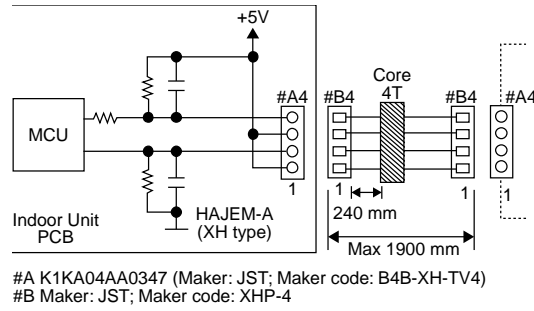

Note: The wire length from indoor unit to the external interface must be within 1.9 meters. The wire must be double insulation type and a ferrite core to be added to reduce noise. Proposed core spec is JOKE00000147 with Heat Shrinkage Tube.

The signal between indoor unit and the external interface must be isolated by photo-coupler of approval type (e.g: Semko, VDE etc).

15. Operation Control (For Multi Split Connection)

During multi split connection, indoor unit's operation controls are same with single split connection unless specified in this chapter.

15.1 Cooling operation

15.1.1 Thermostat control

- Capability supply to indoor unit is OFF (Expansion valve closed) when Intake Air Temperature — Internal setting temperature $< -2.0^{\circ}\text{C}$.
- Capability resume supply to indoor unit after waiting for 3 minutes, if the Intake Air temperature — Internal setting temperature $>$ Capability supply OFF point.

15.2 Soft Dry Operation

15.2.1 Thermostat control

- Capability supply to indoor unit is OFF (Expansion valve closed) when Intake Air Temperature — Internal setting temperature $< -3.0^{\circ}\text{C}$.
- Capability resume to indoor unit after waiting for 3 minutes, if the Intake Air temperature — Internal setting temperature $>$ Capability supply OFF point.

15.3 Heating Operation

15.3.1 Thermostat control

- Capability supply to indoor unit is OFF (Expansion valve closed) when Intake Air Temperature — Internal setting temperature $> +1.0^{\circ}\text{C}$.
- During this condition, the indoor fan is stopped if compressor is ON.
- Capability resume supply to indoor unit after waiting for 3 minutes, if the Intake Air Temperature — Internal setting temperature $<$ Capability supply OFF point.

15.3.2 Temperature Sampling Control

- Temperature sampling is controlled by outdoor unit where room temperature for all power supply ON indoor unit could be obtained.
- When capability supply to the indoor unit is OFF and the compressor is ON, the indoor fan motor is stopped. During this condition, 15 seconds after sampling signal from outdoor unit is received, the indoor fan start operation at low fan speed.
- However, within first 4 minutes of capability stopped supply to the indoor unit, even sampling signal is received, the sampling control is cancelled.

15.4 Automatic Operation

- This mode can be set using remote control and the operation is decided by remote control setting temperature, remote control operation mode, indoor intake and outdoor air temperature.
- During operation mode judgment, indoor fan motor (with speed of -Lo) and outdoor fan motor are running for 30 seconds to detect the indoor intake and outdoor air temperature. The operation mode is decided based on below chart.

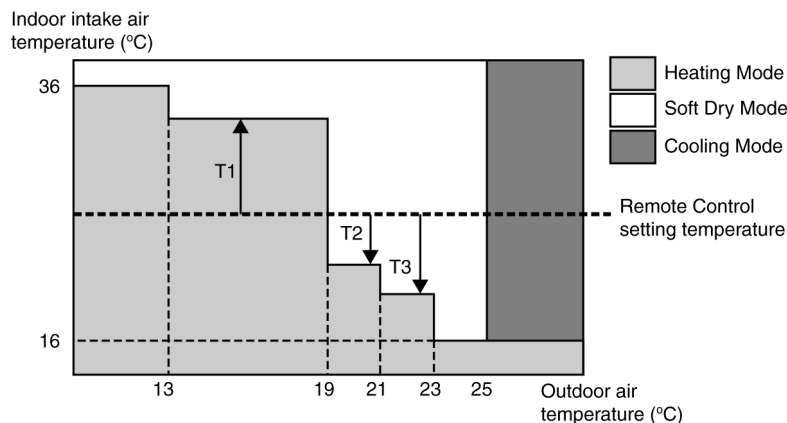

- Every 180 minutes, the indoor and outdoor temperature is judge. Based on remote control setting temperature, the value of T1 will increase up to 10°C, T2 will decrease by 3°C and T3 will decrease up to 8°C.

15.5 Indoor Fan Motor Operation

15.5.1 Residual Heat Removal Control

- To prevent high pressure at indoor unit, when heating mode thermostat-off condition or power supply OFF, indoor fan continue to operate at controlled fan speed for maximum 30 seconds then stop.

15.6 Powerful Mode Operation

- When the powerful mode is selected, the internal setting temperature will shift lower up to 4.0°C for Cooling/Soft Dry or higher up to 6.0°C for heating than remote control setting temperature. This operation stops automatically after 20 minutes.

15.7 Auto Restart Control

- When the power supply is cut off during the operation of air conditioner, the compressor will re-operate between three to four minutes (10 patterns to be selected randomly) after power resume.
- During multi split connection, Indoor unit will resume previous mode, include unit standby mode.

15.8 Indication Panel

LED	POWER	TIMER	POWERFUL	QUIET	AIR SWING
Color	Green	Orange	Orange	Orange	Orange
Light ON	Operation ON	Timer Setting ON	POWERFUL Mode ON	QUIET Mode ON	AIR SWING ON
Light OFF	Operation OFF	Timer Setting OFF	POWERFUL Mode OFF	QUIET Mode OFF	AIR SWING OFF

Note:

- If POWER LED is blinking (0.5 seconds ON, 0.5 second OFF), the possible operation of the unit are during Indoor Residual Heat Removal, Hot Start, during Deice operation, operation mode judgment, or ON timer sampling.
- If POWER LED is blinking (2.5 seconds ON, 0.5 second OFF), the unit is in standby mode.
- If TIMER LED is blinking, there is an abnormality operation occurs.

16. Protection Control

16.1 Protection Control for All Operations

16.1.1 Restart Control (Time Delay Safety Control)

- The Compressor will not turn on within 3 minutes from the moment operation stops, although the unit is turned on again by pressing OFF/ON button at remote control within this period.
- This control is not applicable if the power supply is cut off and on again.
- This phenomenon is to balance the pressure inside the refrigerant cycle.

16.1.2 Total Running Current

- 1 When the outdoor unit total running current (AC) exceeds X value, the frequency instructed for compressor operation will be decreased.
- 2 If the running current does not exceed X value for 5 seconds, the frequency instructed will be increased.
- 3 However, if total outdoor unit running current exceeds Y value, compressor will be stopped immediately for 3 minutes.

Model	Z25UB4EAW		Z35UB4EAW		Z50UB4EAW		Z60UB4EAW	
Operation Mode	X (A)	Y (A)	X (A)	Y (A)	X (A)	Y (A)	X (A)	Y (A)
Cooling / Soft Dry (A)	4.07	14.66	6.34	14.66	10.41	14.66	12.31	14.66
Cooling / Soft Dry (B/C)	3.62		5.88		9.96		11.86	
Heating	5.25		6.61		10.14		11.59	

- 4 The first 30 minutes of cooling operation, (A) will be applied.

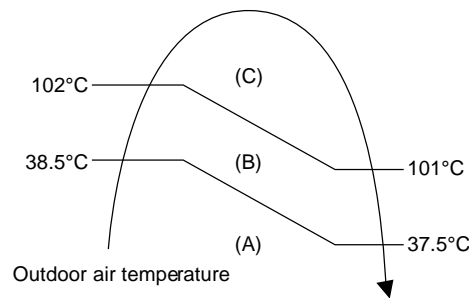

16.1.3 IPM (Power transistor) Prevention Control

- Overheating Prevention Control
 - 1 When the IPM temperature rises to 120°C, compressor operation will stop immediately.
 - 2 Compressor operation restarts after 3 minutes the temperature decreases to 110°C.
 - 3 If this condition repeats continuously 4 times within 20 minutes, timer LED will be blinking ("F96" is indicated).
- DC Peak Current Control
 - 1 When electric current to IPM exceeds set value of 16.0 ± 2.0A (Z25/35UB4) and 30.0 ± 3.0A (Z50/60UB4), the compressor will stop operate. Then, operation will restart after 3 minutes.
 - 2 If the set value is exceeded again more than 30 seconds after the compressor starts, the operation will restart after 1 minute.
 - 3 If the set value exceeded again within 30 seconds after the compressor starts, the operation will restart after 1 minute. If this condition repeats continuously for 7 times, all indoor and outdoor relays will be cut off, timer LED will be blinking ("F99" is indicated).

16.1.4 Compressor Overheating Prevention Control

- Instructed frequency for compressor operation will be regulated by compressor temperature. The changes of frequency are as below.
- If compressor temperature exceeds 103°C, compressor will be stopped, occurs 4 times per 20 minutes, timer LED will be blinking. ("F97" is indicated.)

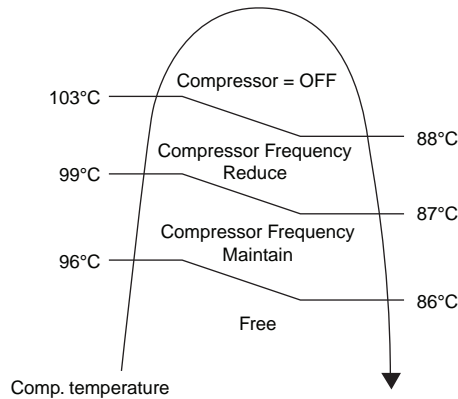

16.1.5 Low Pressure Prevention Control (Gas Leakage Detection)

- Control start conditions
 - For 5 minutes, the compressor continuously operates and outdoor total current is between 0.75A and 0.95A (Z25/35UB4), 1.38A and 1.65A (Z50/60UB4).
 - During Cooling and Soft Dry operations:
Indoor suction temperature - indoor piping temperature is below 4°C.
 - During Heating operations :
Indoor piping temperature - indoor suction is under 5°C.
- Control contents
 - Compressor stops (and restart after 3 minutes).
 - If the conditions above happen 2 times within 20 minutes, the unit will:
 - Stop operation
 - Timer LED blinks and "F91" indicated.

16.1.6 Low Frequency Protection Control 1

- When the compressor operate at frequency lower than 24 Hz continued for 20 minutes, the operation frequency will be changed to 23 Hz for 2 minutes.

16.1.7 Low Frequency Protection Control 2

- When all the below conditions comply, the compressor frequency will change to lower frequency.

Temperature, T, for:	Cooling/Soft Dry	Heating
Indoor intake air (°C)	T < 14 or T ≥ 30	T < 14 or T ≥ 28
Outdoor air (°C)	T < 13 or T ≥ 38	T < 4 or T ≥ 24
Indoor heat exchanger (°C)	T < 30	T ≥ 0

16.2 Protection Control for Cooling & Soft Dry Operation

16.2.1 Outdoor Air Temperature Control

- The compressor operating frequency is regulated in accordance to the outdoor air temperature as shown in the diagram below.
- This control will begin 1 minute after the compressor starts.
- Compressor frequency will adjust base on outdoor air temperature.

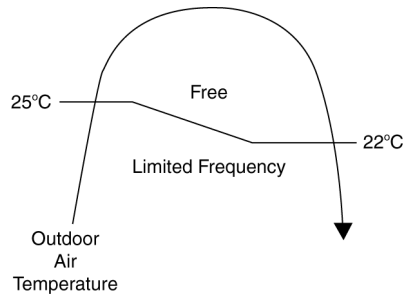

- The compressor will be stopped to avoid compressor overloading.

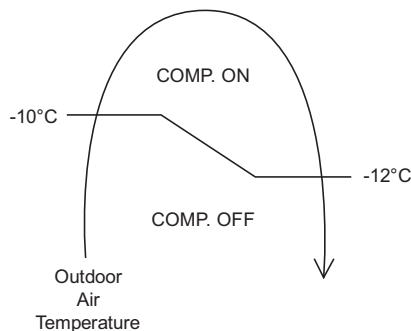

16.2.2 Cooling Overload Control

- Detects the Outdoor pipe temperature and carry out below restriction/limitation (Limit the compressor Operation frequency).
- The compressor stop if outdoor pipe temperature exceeds 60°C.
- If the compressor stops 4 times in 20 minutes, Timer LED blinking (F95 indicated: outdoor high pressure rise protection).

16.2.3 Freeze Prevention Control 1

- When indoor heat exchanger temperature is lower than 0°C continuously for 6 minutes, compressor will stop operating.
- Compressor will resume its operation 3 minutes after the indoor heat exchanger is higher than 5°C.
- At the same time, indoor fan speed will be higher than during its normal operation.
- If indoor heat exchanger temperature is higher than 5°C for 5 minutes, the fan speed will return to its normal operation.

16.2.4 Freeze Prevention Control 2

- Control start conditions
 - During Cooling operation and soft dry operation
 - During thermo OFF condition, indoor intake temperature is less than 10°C or
 - Compressor stops for freeze prevention control
 - Either one of the conditions above occurs 5 times in 60 minutes.
- Control contents
 - Operation stops
 - Timer LED blinks and "H99" indicated

16.2.5 Dew Prevention Control 1

- To prevent dew formation at indoor unit discharge area.
- This control will be activated if:
 - Outdoor air temperature and Indoor pipe temperature judgment by microcontroller is fulfilled.
 - When Cooling or Dry mode is operated more than 20 minutes or more.
- This control stopped if:
 - Compressor stopped.
 - Remote control setting changed (fan speed / temperature).
 - Outdoor air temperature and indoor intake temperature changed.
- Fan speed will be adjusted accordingly in this control.

16.2.6 Odor Cut Control

- To reduce the odor released from the unit.
 - Start Condition
 - AUTO FAN Speed is selected during COOL or DRY operation.
 - During freeze prevention control and timer preliminary operation, this control is not applicable.
 - Control content
 - Depends on compressor conditions:
 1. Compressor OFF → Compressor ON.
The indoor unit fan stops temporarily and then starts to blow at minimum airflow for 30 seconds.
 2. Compressor ON → Compressor OFF.
The indoor unit fan stops for 90 seconds and then blows at minimum airflow for 20 seconds.

16.3 Protection Control for Heating Operation

16.3.1 Intake Air Temperature Control

Compressor will operate at limited freq., if indoor intake air temperature is 30°C or above.

16.3.2 Outdoor Air Temperature Control

- The Max current value is regulated when the outdoor air temperature rise above 14°C in order to avoid compressor overloading.

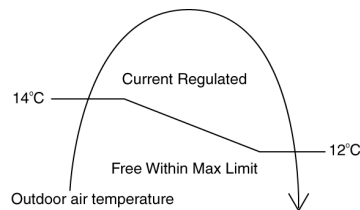

16.3.3 Overload Protection Control

- The compressor operating frequency is regulated in accordance to indoor heat exchanger temperature as shown below.
- If the heat exchanger temperature exceeds 60°C, compressor will stop.

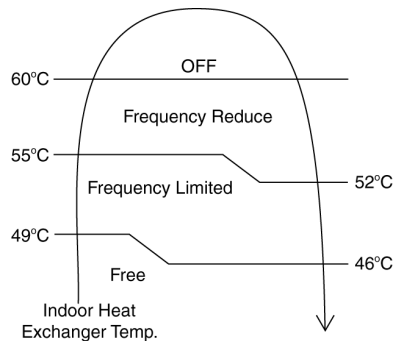

16.3.4 Low Temperature Compressor Oil Return Control

- In heating operation, if the outdoor temperature falls below -10°C when compressor starts, the compressor frequency will be regulated up to 600 seconds.

16.3.5 Cold Draught Prevention Control

- When indoor pipe temperature is low, cold draught operation starts where indoor fan speed will be reduced.

16.3.6 Deice Operation

- When outdoor pipe temperature and outdoor air temperature is low, deice operation start where indoor fan motor and outdoor fan motor stop and operation LED blinks.

16.3.7 Low Pressure Protection Control

- During low ambient heating operation, if the pipe temperature drops below -24°C, the max frequency will be reduced and limited.
- If it does not rises after 3 minutes, the compressor will stop.
- The compressor will start again if the pipe temperature rises above -20°C.

17. Servicing Mode

17.1 Auto OFF/ON Button

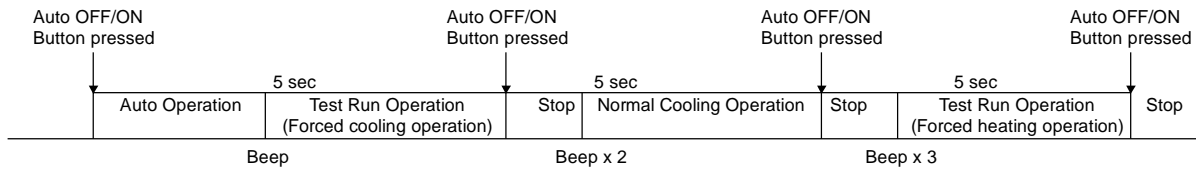

1 AUTO OPERATION MODE

The Auto operation will be activated immediately once the Auto OFF/ON button is pressed. This operation can be used to operate air conditioner with limited function if remote control is misplaced or malfunction.

2 TEST RUN OPERATION (FOR PUMP DOWN/SERVICING PURPOSE)

The Test Run operation will be activated if the Auto OFF/ON button is pressed continuously for more than 5 seconds. A “beep” sound will heard at the fifth seconds, in order to identify the starting of Test Run operation (Forced cooling operation). Within 5 minutes after Forced cooling operation start, the Auto OFF/ON button is pressed for more than 5 seconds. A 2 “beep” sounds will heard at the fifth seconds, in order to identify the starting of Normal cooling operation.

Within 5 minutes after Normal cooling operation start, the Auto OFF/ON button is pressed for more than 5 seconds. A 3 “beep” sounds will be heard at the fifth seconds, in order to identify the starting of Forced heating operation.

The Auto OFF/ON button may be used together with remote control to set / change the advance setting of air conditioner operation.

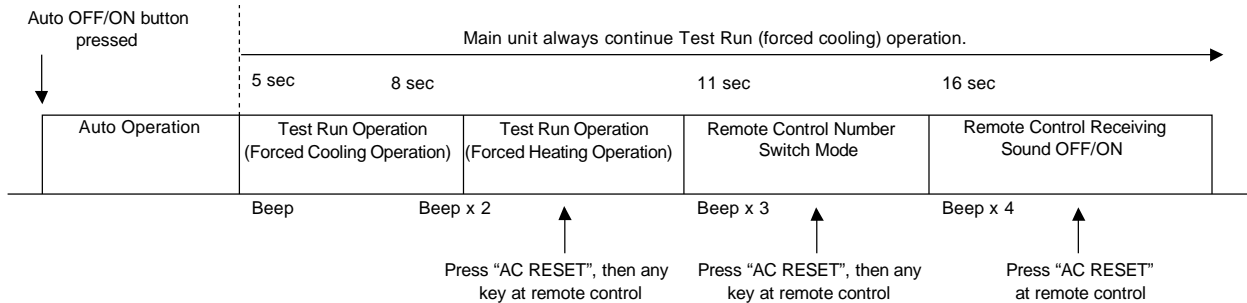

3 REMOTE CONTROL NUMBER SWITCH MODE

The Remote Control Number Switch Mode will be activated if the Auto OFF/ON button is pressed continuously for more than 11 seconds (3 “beep” sounds will occur at 11th seconds to identify the Remote Control Number Switch Mode is in standby condition) and press “AC RESET” button and then press any button at remote control to transmit and store the desired transmission code to the EEPROM.

There are 4 types of remote control transmission code could be selected and stored in EEPROM of indoor unit. The indoor unit will only operate when received signal with same transmission code from remote control. This could prevent signal interference when there are 2 or more indoor units installed nearby together. To change remote control transmission code, short or open jumpers at the remote control printed circuit board.

Remote Control Printed Circuit Board		
Jumper A (J-A)	Jumper B (J-B)	Remote Control No.
Short	Open	A (Default)
Open	Open	B
Short	Short	C
Open	Short	D

- During Remote Control Number Switch Mode, press any button at remote control to transmit and store the transmission code to the EEPROM.

4 REMOTE CONTROL RECEIVING SOUND OFF/ON MODE

The Remote Control Receiving Sound OFF/ON Mode will be activated if the Auto OFF/ON button is pressed continuously for more than 16 seconds (4 “beep” sounds will occur at 16th seconds to identify the Remote Control Receiving Sound Off/On Mode is in standby condition) and press “AC Reset” button at remote control.

Press “Auto OFF/ON button” to toggle remote control receiving sound.

- Short “beep”: Turn OFF remote control receiving sound.
- Long “beep”: Turn ON remote control receiving sound.

After Auto OFF/ON Button is pressed, the 20 seconds counter for Remote Control Receiving Sound OFF/ON Mode is restarted.

17.2 Heat Only Operation

17.2.1 How to Activate/Deactivate Heat only Operation

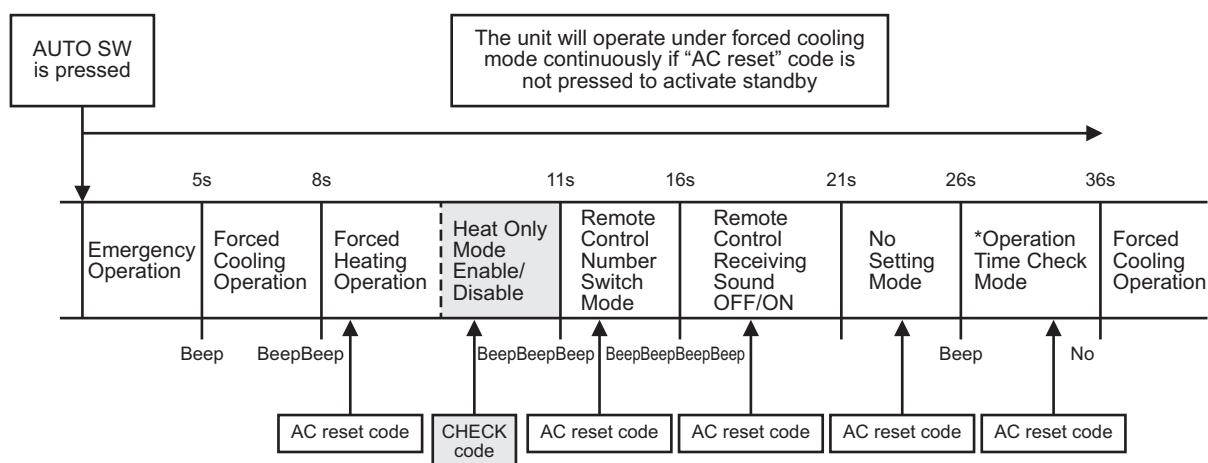

- To enable the “Heat Only” mode, press the AUTO OFF/ON SW for more than 8s and less than 11s, “Beep Beep” sound will be heard, then release the AUTO OFF/ON SW and press remote controller CHECK button. A short “Beep” sound will be heard. “Heat Only” mode is now enable.
- To disable the “Heat Only” mode, press the AUTO OFF/ON SW for more than 8s and less than 11s, “Beep Beep” sound will be heard, then release the AUTO OFF/ON SW and press remote controller CHECK button. A long “Beep” sound will be heard. “Heat Only” mode is now disable.
- To pump down the unit during Heat Only Operation press AUTO switch for 5 seconds.

17.2.2 Operation mode during Heating Only Operation

- The table below shows the operation mode comparison when Heating Only Operation Mode Activated and Deactivated.

Operation Mode	Heating Only Operation Mode Activated	Heating Only Operation Mode Deactivated
AUTO	After 30s sampling, regardless of the indoor intake or outdoor intake temperature judgment, the unit will run Heating operation.	After 30s sampling, the unit will judge the operation mode base on remote controller temperature setting and Indoor Intake Sensor (New Auto Mode) or Outdoor Intake Sensor (Old Auto Mode).
HEAT	The unit will run Heating operation.	The unit will run Heating operation.
COOL	The unit will stop and Power LED blinking.	The unit will run Cooling operation.
DRY	The unit will stop and Power LED blinking.	The unit will run Cooling Dry operation.
NANOE Stand-alone	The unit will stop and Power LED blinking.	The unit will run Naoe Stand-alone operation.
Force Cooling	The unit will run Force Cooling Operation for X_CTRYTM [15] minutes	The unit will run Force Cooling operation.
Force Heating	The unit will run Force Heating operation.	The unit will run Force Heating operation.
AUTO (with Timer)	The unit will turn ON by the timer and run Auto Operation. After 30s sampling, regardless of the indoor intake or outdoor intake temperature judgment, the unit will run Heating operation.	The unit will turn ON by the timer and run Auto Operation. After 30s sampling, the unit will judge the operation mode base on remote controller temperature setting and Indoor Intake Sensor (New Auto Mode) or Outdoor Intake Sensor (Old Auto Mode).
HEAT (with Timer)	The unit will turn ON by the timer and run Heating Operation.	The unit will turn ON by the timer and run Heating Operation.
COOL (with Timer)	The unit will not turn ON by the timer. Power LED blinking.	The unit will turn ON by the timer and run Cooling Operation.
DRY (with Timer)	The unit will not turn ON by the timer. Power LED blinking.	The unit will turn ON by the timer and run Cooling Dry Operation.
Cooling Test Mode	The unit will stop and Power LED blinking.	The unit will operate according to specify Cooling test mode operation parameter.
Heating Test Mode	The unit will operate according to specify Heating test mode operation parameter.	The unit will operate according to specify Heating test mode operation parameter.

17.3 Remote Control Button

17.3.1 SET Button

- To check remote control transmission code and store the transmission code to EEPROM:
 - Press "Set" button by using pointer.
 - Press "Timer Set" button until a "beep" sound is heard as confirmation of transmission code changed.
- To limit set temperature range for COOL & DRY, HEAT mode.
 - Press "Set" button by using pointer.
 - Press TEMP increment or decrement button to choose No. 3.
 - Press Timer increment or decrement button to select desired temperature low limit of set temperature for COOL & DRY mode.
 - Press Timer Set button to confirm low limit selection.
 - Press TEMP increment or decrement button to choose No. 4.
 - Press Timer decrement or increment button to select desired temperature high limit of set temperature for COOL & DRY mode.
 - Press Timer Set button to confirm high limit selection.
 - Press TEMP increment or decrement button to choose No. 5.
 - Press Timer increment or decrement button to select desired temperature low limit of set temperature for HEAT mode.
 - Press Timer Set button to confirm low limit selection.
 - Press TEMP increment or decrement button to choose No. 6.
 - Press Timer decrement or increment button to select desired temperature high limit of set temperature for HEAT mode.
 - Press Timer Set button to confirm high limit selection.
 - LCD returns to original display if remote control does not operate for 30 seconds or press Timer Cancel button.

17.3.2 RESET (RC)

- To clear and restore the remote control setting to factory default.
 - Press once to clear the memory.

17.3.3 RESET (AC)

- To restore the unit's setting to factory default.
 - Press once to restore the unit's setting.

17.3.4 TIMER ▲

- To change indoor unit indicator's LED intensity.
 - Press continuously for 5 seconds.

17.3.5 TIMER ▼

- To change remote control display from Degree Celsius (°C) to Degree Fahrenheit (°F).
 - Press continuously for 10 seconds.

17.3.6 Special Setting mode

- LCD display area:

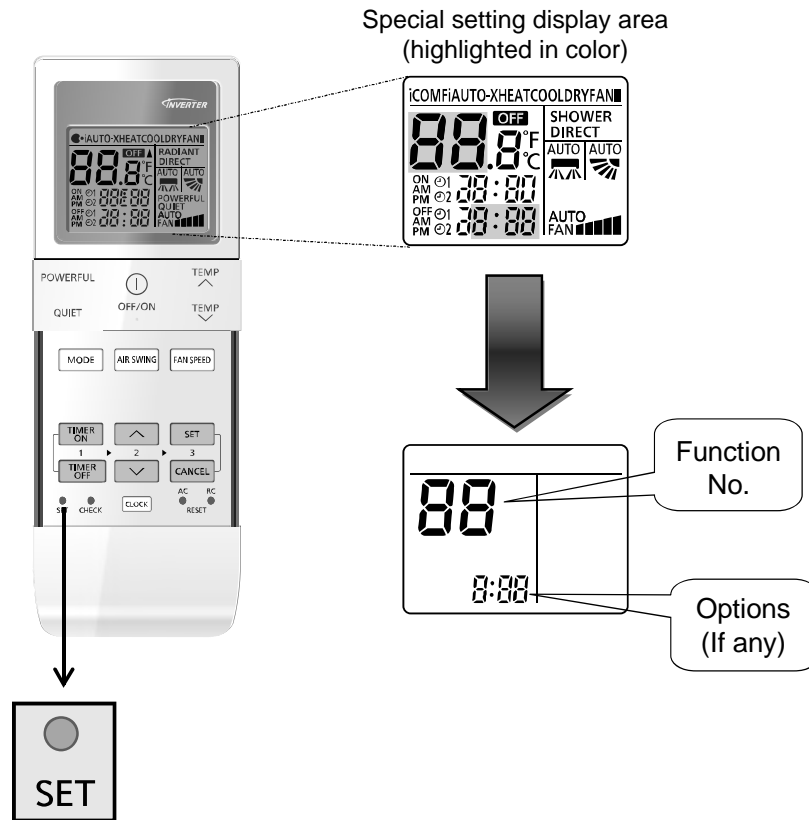

- Cannot enter this special setting mode under the following conditions:
 - Operation ON.
 - Under [Real/ON/OFF] time setting mode.

3 To enter zone 1 area:

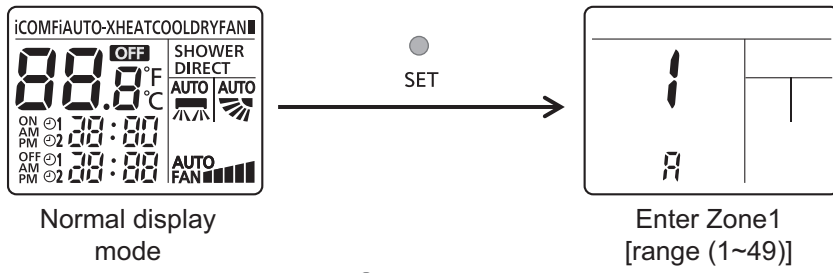

4 To enter zone 2 area: (Press SET continuously for T ≥ 5 secs)

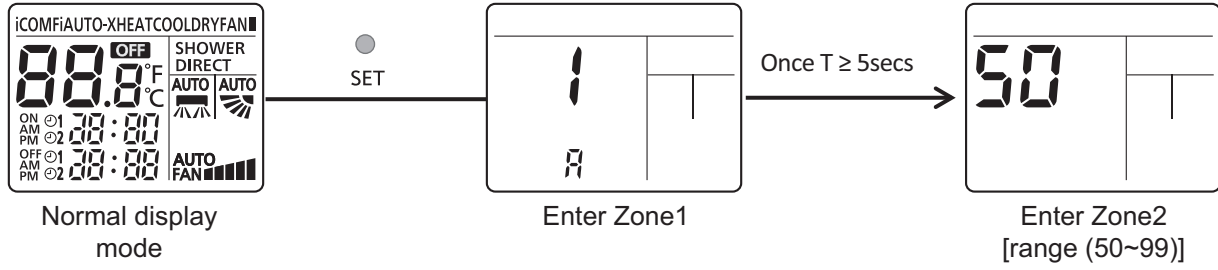

5 Function & Options list:

Note: The functions described in the table may not be applicable to the model and may subject to change without further notice.

		Function		Options	Remark	
		No	Name			
Zone 1	1	Remote control number selection		A, B, C, D		
	2	Solar radiation sensitivity level adjustment		1, 2, 3, 4, 5		
	3	[iAUTO-X/iAUTO/iCOMF, Cool & Dry] mode set temperature [Low2] selection			16°C ~ [High2]	
	4	[iAUTO-X/iAUTO/iCOMF, Cool & Dry] mode set temperature [High2] selection			[Low2] ~ 30°C	
	5	Heat mode set temperature Low1 selection			16°C ~ [High1]	
	6	Heat mode set temperature High1 selection			[Low1] ~ 30°C	
	7	Filter cleaning disable/enable selection			00 / 01	
	8	nanoe-G default ON disable/enable selection			00 / 01	
	9	Dust sensor monitoring & LED disable/enable selection			00 / 01	
	10	Auto restart disable/enable selection			00 / 01	
	11	Dust sensor sensitivity level adjustment			1, 2, 3	
	12 ~ 49	Reserve				
Zone 2	50	ECO demo ON		None (No display)		
	51	Light sensor check		None (No display)		
	52	nanoe-G / ECO sensor check		None (No display)		
	53	DOA check		None (No display)		
	54	Odor cut control selection [Enable (01) / Disable (00)]			00 / 01	
	55	Frequency tolerance selection [± 3 Hz (03) / ± 7 Hz (07)]			03 / 07	
	56	Fixed fan speed selection during heat mode compressor OFF [Enable (01) / Disable (00)]			00/01	
	57	nanoe check		None (No display)		
	58	Heat mode thermo shift adjustment			-3°C ~ 3°C	
	59	Others (Cool & Dry) mode thermo shift adjustment			-3°C ~ 3°C	
	60	Deice start determination judgment temperature switching [Yes (01) / No (00)]			00/01	
	61	Cool mode disable selection [Yes (01) / No (00)]			00/01	
	62	Heat mode disable selection [Yes (01) / No (00)]			00/01	
	63	Base pan heater selection [Base pan A (A) / Base pan B (b)]			A / b	
	64	Disable fan speed reduction during cool mode thermo-Off [Yes (01) / No (00)]			00/01	
	65	LED smart OFF selection			00 – Disable / 01 – Enable	
	66	nanoe-g ON/OFF duration selection			01 – Pattern 1 / 02 – Pattern 2 / 03 – Pattern 3 / 04 – Pattern 4	
	67	Operation OFF deice function selection			00 – Disable / 01 – Enable	
68	Compressor frequency change speed selection			01 – Pattern 1 / 02 – Pattern 2 / 03 – Pattern 3		
69 ~ 99	Reserve					

18. Troubleshooting Guide

18.1 Refrigeration Cycle System

In order to diagnose malfunctions, make sure that there are no electrical problems before inspecting the refrigeration cycle. Such problems include insufficient insulation, problem with the power source, malfunction of a compressor and a fan. The normal outlet air temperature and pressure of the refrigeration cycle depends on various conditions, the standard values for them are shown in the table on the right.

Normal Pressure and Outlet Air Temperature (Standard)

	Gas Pressure MPa (kg/cm ² G)	Outlet air Temperature (°C)
Cooling Mode	0.9 ~ 1.2 (9 ~ 12)	13 ~ 17
Heating Mode	2.0 ~ 2.7 (20 ~ 27)	32 ~ 42

- *Condition:
- Indoor fan speed = High
 - Outdoor temperature 35°C at the cooling mode and 7°C at the heating mode
 - Compressor operates at rated frequency

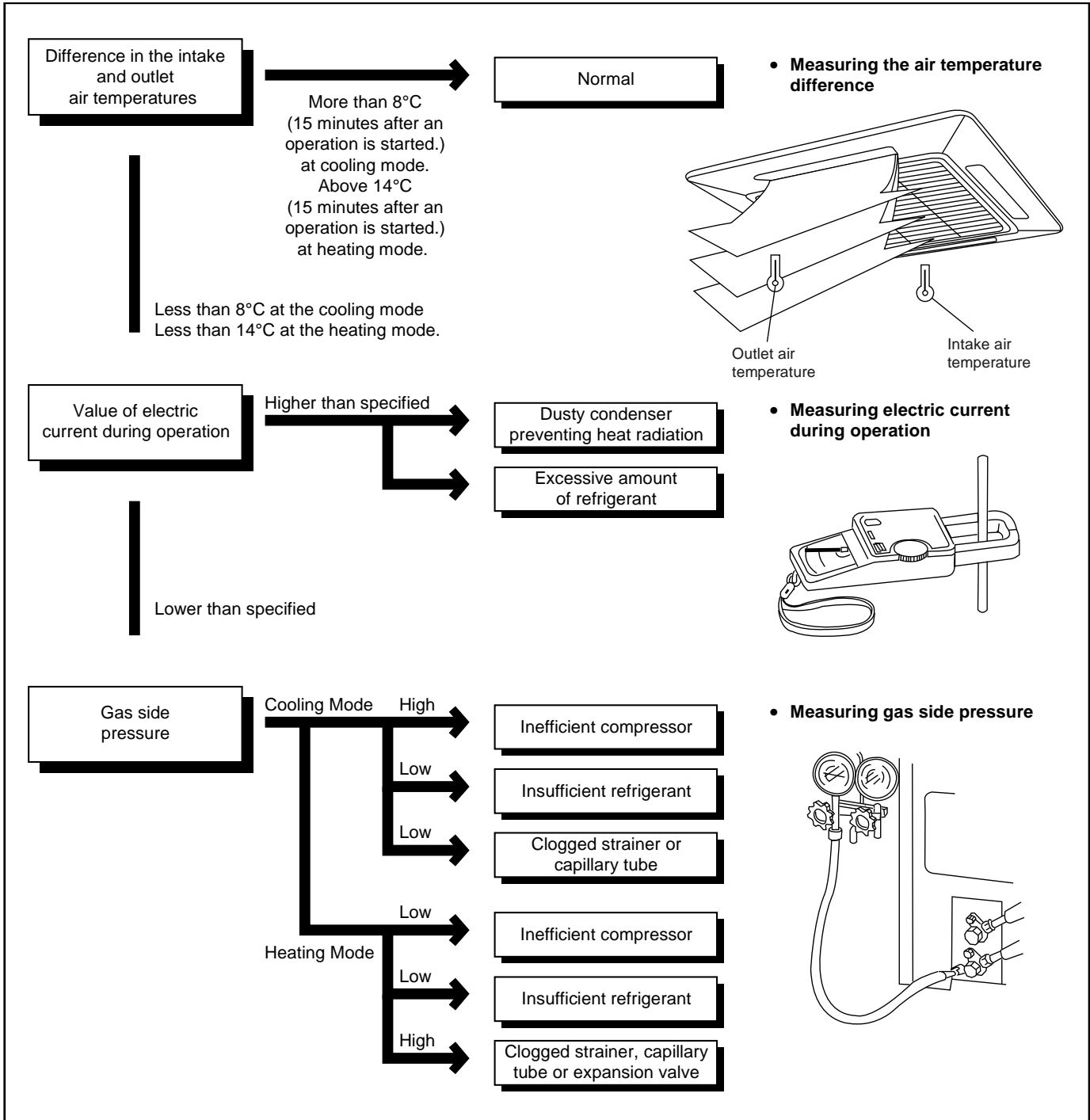

18.1.1 Relationship Between the Condition of the Air Conditioner and Pressure and Electric Current

Condition of the air conditioner	Cooling Mode			Heating Mode		
	Low Pressure	High Pressure	Electric current during operation	Low Pressure	High Pressure	Electric current during operation
Insufficient refrigerant (gas leakage)	↘	↘	↘	↘	↘	↘
Clogged capillary tube or Strainer	↘	↘	↘	↗	↗	↗
Short circuit in the indoor unit	↘	↘	↘	↗	↗	↗
Heat radiation deficiency of the outdoor unit	↗	↗	↗	↘	↘	↘
Inefficient compression	↗	↘	↘	↗	↘	↘

- Carry out the measurement of pressure, electric current, and temperature fifteen minutes after an operation is started.

18.2 Breakdown Self Diagnosis Function

18.2.1 Self Diagnosis Function (Three Digits Alphanumeric Code)

- Once abnormality has occurred during operation, the unit will stop its operation, and Timer LED blinks.
 - Although Timer LED goes off when power supply is turned off, if the unit is operated under a breakdown condition, the LED will light up again.
 - In operation after breakdown repair, the Timer LED will no more blink. The last error code (abnormality) will be stored in IC memory.
- 6 When the latest abnormality code on the main unit and code transmitted from the remote controller are matched, power LED will light up for 30 seconds and a beep sound (continuously for 4 seconds) will be heard. If no codes are matched, power LED will light up for 0.5 seconds and no sound will be heard.

18.2.2 To Make a Diagnosis

- 1 Timer LED start to blink and the unit automatically stops the operation.
- 2 Press the CHECK button on the remote controller continuously for 5 seconds.
- 3 “- -” will be displayed on the remote controller display.
Note: Display only for “- -”. (No transmitting signal, no receiving sound and no Power LED blinking.)
- 4 Press the “TIMER” ▲ or ▼ button on the remote controller. The code “H00” (no abnormality) will be displayed and signal will be transmitted to the main unit.
- 5 Every press of the button (up or down) will increase abnormality numbers and transmit abnormality code signal to the main unit.
- 6 When the latest abnormality code on the main unit and code transmitted from the remote controller are matched, power LED will light up for 30 seconds and a beep sound (continuously for 4 seconds) will be heard. If no codes are matched, power LED will light up for 0.5 seconds and no sound will be heard.
- 7 The breakdown diagnosis mode will be canceled unless pressing the CHECK button continuously for 5 seconds or operating the unit for 30 seconds.
- 8 The LED will be off if the unit is turned off or the RESET button on the main unit is pressed.

18.2.3 To Display Memorized Error Code (Protective Operation)

- 1 Turn power on.
- 2 Press the CHECK button on the remote controller continuously for 5 seconds.
- 3 “- -” will be displayed on the remote controller display.
Note: Display only for “- -”. (No transmitting signal, no receiving sound and no Power LED blinking.)
- 4 Press the “TIMER” ▲ or ▼ button on the remote controller. The code “H00” (no abnormality) will be displayed and signal will be transmitted to the main unit. The power LED lights up. If no abnormality is stored in the memory, three beeps sound will be heard.
- 5 Every press of the button (up or down) will increase abnormality numbers and transmit abnormality code signal to the main unit.

- 7 The breakdown diagnosis mode will be canceled unless pressing the CHECK button continuously for 5 seconds or operating the unit for 30 seconds.

- 8 The same diagnosis can be repeated by turning power on again.



18.2.4 To Clear Memorized Error Code after Repair (Protective Operation)

- 1 Turn power on (in standby condition).
- 2 Press the AUTO button for 5 seconds (A beep receiving sound) on the main unit to operate the unit at Forced Cooling Operation modes.
- 3 Press the CHECK button on the remote controller for about 1 second with a pointed object to transmit signal to main unit. A beep sound is heard from main unit and the data is cleared.

18.2.5 Temporary Operation (Depending On Breakdown Status)

- 1 Press the AUTO button (A beep receiving sound) on the main unit to operate the unit. (Remote control will become possible.)
- 2 The unit can temporarily be used until repaired.

18.3 Error Codes Table

Diagnosis display	Abnormality / Protection control	Abnormality Judgment	Protection Operation	Problem	Check location
H00	No memory of failure	—	Normal operation	—	—
H11	Indoor/outdoor abnormal communication	After operation for 1 minute	Indoor fan only operation can start by entering into force cooling operation	Indoor/outdoor communication not establish	<ul style="list-style-type: none"> Indoor/outdoor wire terminal Indoor/outdoor PCB Indoor/outdoor connection wire
H12	Indoor unit capacity unmatched	90s after power supply	—	Total indoor capability more than maximum limit or less than minimum limit, or number of indoor unit less than two	<ul style="list-style-type: none"> Indoor/outdoor connection wire Indoor/outdoor PCB Specification and combination table in catalogue
H14	Indoor intake air temperature sensor abnormality	Continuous for 5s	—	Indoor intake air temperature sensor open or short circuit	<ul style="list-style-type: none"> Indoor intake air temperature sensor lead wire and connector
H15	Compressor temperature sensor abnormality	Continuous for 5s	—	Compressor temperature sensor open or short circuit	<ul style="list-style-type: none"> Compressor temperature sensor lead wire and connector
H16	Outdoor current transformer (CT) abnormality	—	—	Current transformer faulty or compressor faulty	<ul style="list-style-type: none"> Outdoor PCB faulty or compressor faulty
H19	Indoor fan motor mechanism lock	Continuous happen for 7 times	—	Indoor fan motor lock or feedback abnormal	<ul style="list-style-type: none"> Fan motor lead wire and connector Fan motor lock or block
H21	Indoor float switch operation abnormal	—	—	—	—
H23	Indoor heat exchanger temperature sensor abnormality	Continuous for 5s	—	Indoor heat exchanger temperature sensor open or short circuit	<ul style="list-style-type: none"> Indoor heat exchanger temperature sensor lead wire and connector
H24	Indoor heat exchanger temperature sensor 2 abnormality	Continuous for 5s	—	Indoor heat exchanger temperature sensor 2 open or short circuit	<ul style="list-style-type: none"> Indoor heat exchanger temperature sensor 2 lead wire and connector
H27	Outdoor air temperature sensor abnormality	Continuous for 5s	—	Outdoor air temperature sensor open or short circuit	<ul style="list-style-type: none"> Outdoor air temperature sensor lead wire and connector
H28	Outdoor heat exchanger temperature sensor 1 abnormality	Continuous for 5s	—	Outdoor heat exchanger temperature sensor 1 open or short circuit	<ul style="list-style-type: none"> Outdoor heat exchanger temperature sensor 1 lead wire and connector
H30	Outdoor discharge pipe temperature sensor abnormality	Continuous for 5s	—	Outdoor discharge pipe temperature sensor open or short circuit	<ul style="list-style-type: none"> Outdoor discharge pipe temperature sensor lead wire and connector
H32	Outdoor heat exchanger temperature sensor 2 abnormality	Continuous for 5s	—	Outdoor heat exchanger temperature sensor 2 open or short circuit	<ul style="list-style-type: none"> Outdoor heat exchanger temperature sensor 2 lead wire and connector
H33	Indoor / outdoor misconnection abnormality	—	—	Indoor and outdoor rated voltage different	<ul style="list-style-type: none"> Indoor and outdoor units check
H35	Indoor drain water adverse current abnormal	—	—	—	—
H36	Outdoor gas pipe temperature sensor abnormality	Continuous for 5s	Heating protection operation only	Outdoor gas pipe temperature sensor open or short circuit	<ul style="list-style-type: none"> Outdoor gas pipe temperature sensor lead wire and connector
H37	Outdoor liquid pipe temperature sensor abnormality	Continuous for 5s	Cooling protection operation only	Outdoor liquid pipe temperature sensor open or short circuit	<ul style="list-style-type: none"> Outdoor liquid pipe temperature sensor lead wire and connector
H38	Indoor/Outdoor mismatch (brand code)	—	—	Brand code not match	<ul style="list-style-type: none"> Check indoor unit and outdoor unit
H39	Abnormal indoor operating unit or standby units	3 times happen within 40 minutes	—	Wrong wiring and connecting pipe, expansion valve abnormality, indoor heat exchanger sensor open circuit	<ul style="list-style-type: none"> Check indoor/outdoor connection wire and connection pipe Indoor heat exchanger sensor lead wire and connector Expansion valve and lead wire and connector

Diagnosis display	Abnormality / Protection control	Abnormality Judgment	Protection Operation	Problem	Check location
H41	Abnormal wiring or piping connection	—	—	Wrong wiring and connecting pipe, expansion valve abnormality	<ul style="list-style-type: none"> • Check indoor/outdoor connection wire and connection pipe • Expansion valve and lead wire and connector
H64	Outdoor high pressure sensor abnormality	Continuous for 1 minutes	—	High pressure sensor open circuit during compressor stop	<ul style="list-style-type: none"> • High pressure sensor • Lead wire and connector
H97	Outdoor fan motor mechanism lock	2 times happen within 30 minutes	—	Outdoor fan motor lock or feedback abnormal	<ul style="list-style-type: none"> • Outdoor fan motor lead wire and connector • Fan motor lock or block
H98	Indoor high pressure protection	—	—	Indoor high pressure protection (Heating)	<ul style="list-style-type: none"> • Check indoor heat exchanger • Air filter dirty • Air circulation short circuit
H99	Indoor operating unit freeze protection	—	—	Indoor freeze protection (Cooling)	<ul style="list-style-type: none"> • Check indoor heat exchanger • Air filter dirty • Air circulation short circuit
F11	4-way valve switching abnormality	4 times happen within 30 minutes	—	4-way valve switching abnormal	<ul style="list-style-type: none"> • 4-way valve • Lead wire and connector
F17	Indoor standby units freezing abnormality	3 times happen within 40 minutes	—	Wrong wiring and connecting pipe, expansion valve leakage, indoor heat exchanger sensor open circuit	<ul style="list-style-type: none"> • Check indoor/outdoor connection wire and pipe • Indoor heat exchanger sensor lead wire and connector • Expansion valve lead wire and connector
F90	Power factor correction (PFC) circuit protection	4 times happen within 10 minutes	—	Power factor correction circuit abnormal	<ul style="list-style-type: none"> • Outdoor PCB faulty
F91	Refrigeration cycle abnormality	2 times happen within 20 minutes	—	Refrigeration cycle abnormal	<ul style="list-style-type: none"> • Insufficient refrigerant or valve close
F93	Compressor abnormal revolution	4 times happen within 20 minutes	—	Compressor abnormal revolution	<ul style="list-style-type: none"> • Power transistor module faulty or compressor lock
F94	Compressor discharge overshoot protection	4 times happen within 30 minutes	—	Compressor discharge pressure overshoot	<ul style="list-style-type: none"> • Check refrigeration system
F95	Outdoor cooling high pressure protection	4 times happen within 20 minutes	—	Cooling high pressure protection	<ul style="list-style-type: none"> • Check refrigeration system • Outdoor air circuit
F96	Power transistor module overheating protection	4 times happen within 30 minutes	—	Power transistor module overheat	<ul style="list-style-type: none"> • PCB faulty • Outdoor air circuit (fan motor)
F97	Compressor overheating protection	3 times happen within 30 minutes	—	Compressor overheat	<ul style="list-style-type: none"> • Insufficient refrigerant
F98	Total running current protection	3 times happen within 20 minutes	—	Total current protection	<ul style="list-style-type: none"> • Check refrigeration system • Power source or compressor lock
F99	Outdoor direct current (DC) peak detection	Continuous happen for 7 times	—	Power transistor module current protection	<ul style="list-style-type: none"> • Power transistor module faulty or compressor lock

18.4 Self-diagnosis Method

18.4.1 H11 (Indoor/Outdoor Abnormal Communication)

Malfunction Decision Conditions

- During startup and operation of cooling and heating, the data received from outdoor unit in indoor unit signal transmission is checked whether it is normal.

Malfunction Caused

- Faulty indoor unit PCB.
- Faulty outdoor unit PCB.
- Indoor unit-outdoor unit signal transmission error due to wiring error.
- Indoor unit-outdoor unit signal transmission error due to breaking of wire in the connection wires between the indoor and outdoor units.

Troubleshooting

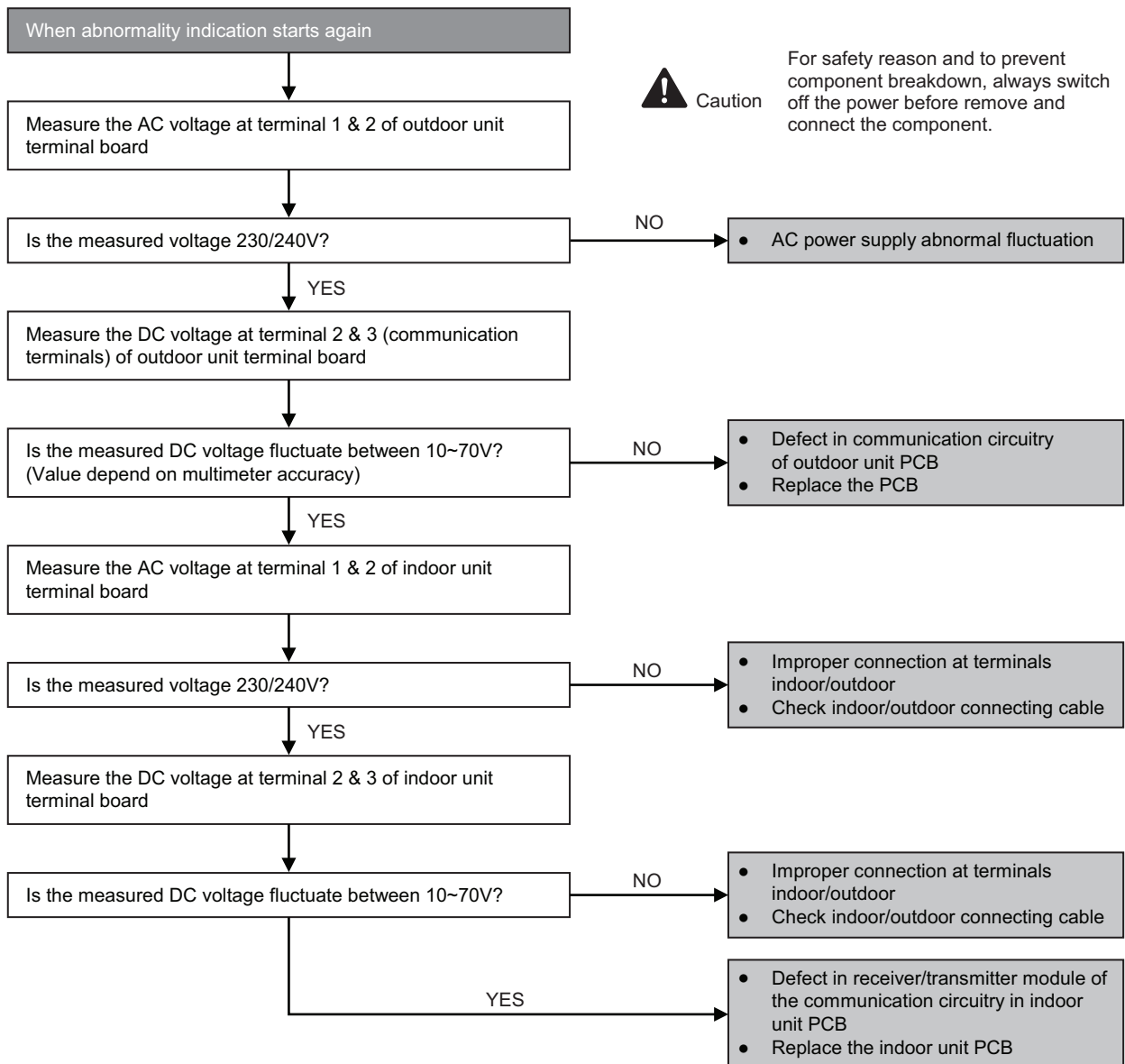

18.4.2 H12 (Indoor/Outdoor Capacity Rank Mismatched)

Malfunction Decision Conditions

- During startup, error code appears when different types of indoor and outdoor units are interconnected.

Malfunction Caused

- Wrong models interconnected.
- Wrong indoor unit or outdoor unit PCBs mounted.
- Indoor unit or outdoor unit PCBs defective.
- Indoor-outdoor unit signal transmission error due to wrong wiring.
- Indoor-outdoor unit signal transmission error due to breaking of wire 3 in the connection wires between the indoor and outdoor units.

Troubleshooting

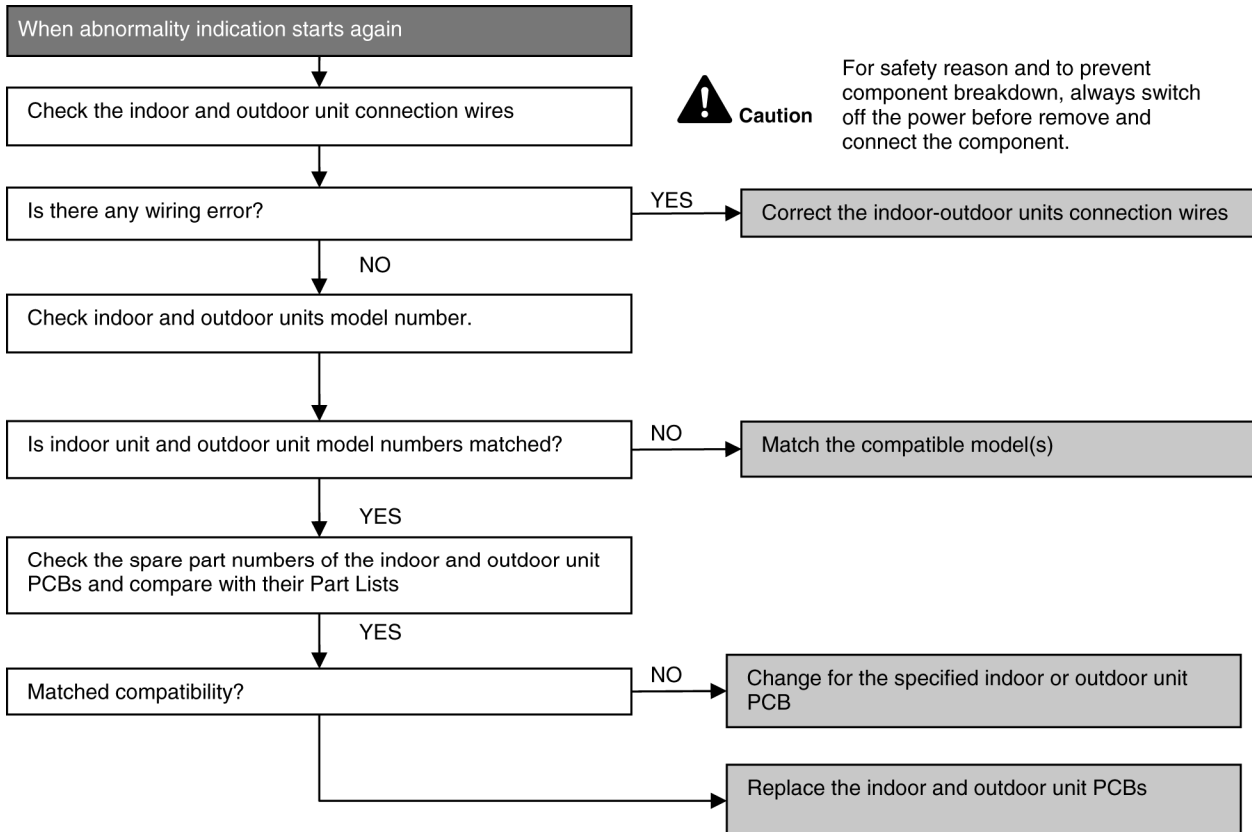

18.4.3 H14 (Indoor Intake Air Temperature Sensor Abnormality)

Malfunction Decision Conditions

- During startup and operation of cooling and heating, the temperatures detected by the indoor intake air temperature sensor are used to determine sensor errors.

Malfunction Caused

- Faulty connector connection.
- Faulty sensor.
- Faulty PCB.

Troubleshooting

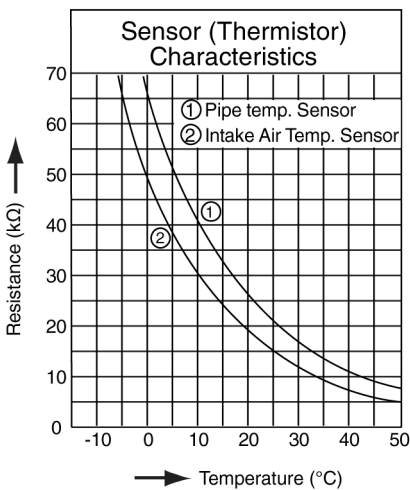
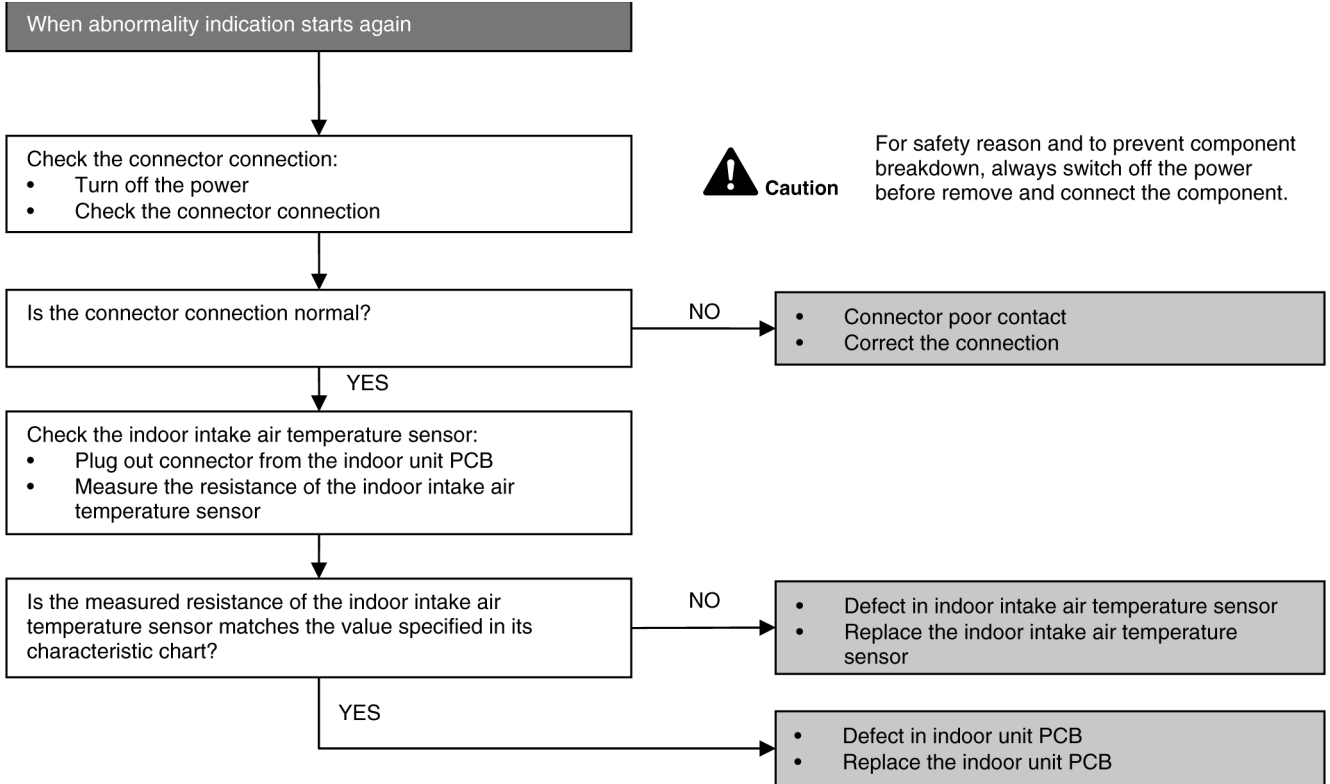

18.4.4 H15 (Compressor Temperature Sensor Abnormality)

Malfunction Decision Conditions

- During startup and operation of cooling and heating, the temperatures detected by the outdoor compressor temperature sensor are used to determine sensor errors.

Malfunction Caused

- Faulty connector connection.
- Faulty sensor.
- Faulty PCB.

Troubleshooting

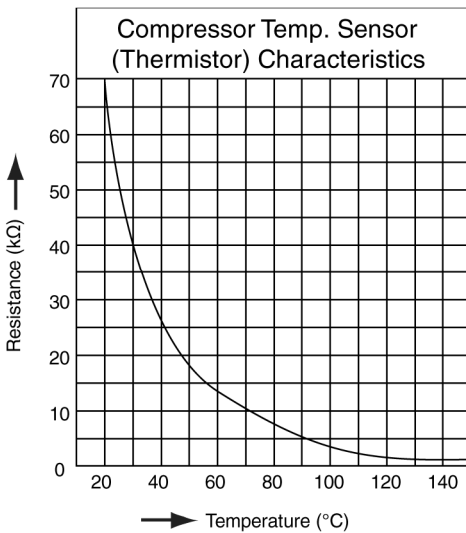
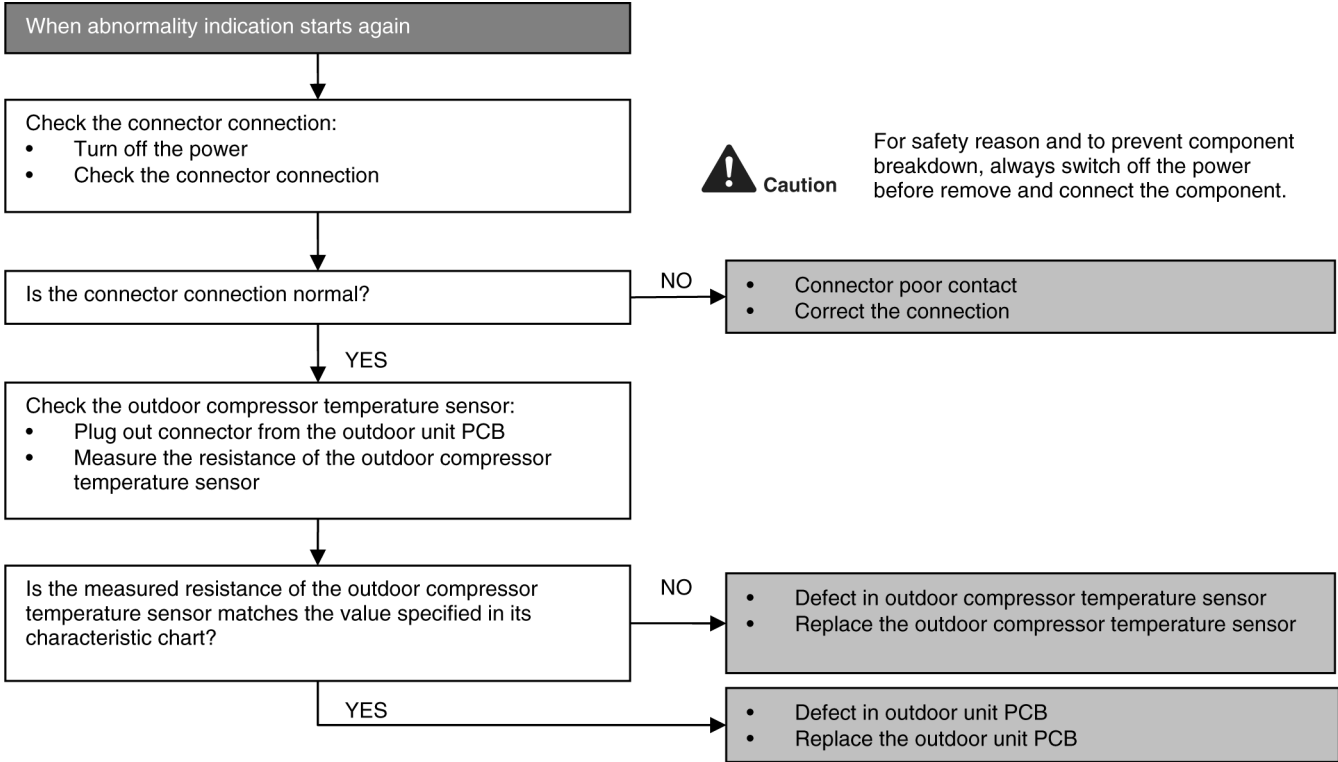

18.4.5 H16 (Outdoor Current Transformer)

Malfunction Decision Conditions

- An input current, detected by Current Transformer CT, is below threshold value when the compressor is operating at certain frequency value for 3 minutes.

Malfunction Caused

- Lack of gas
- Broken CT (current transformer)
- Broken Outdoor PCB

Troubleshooting

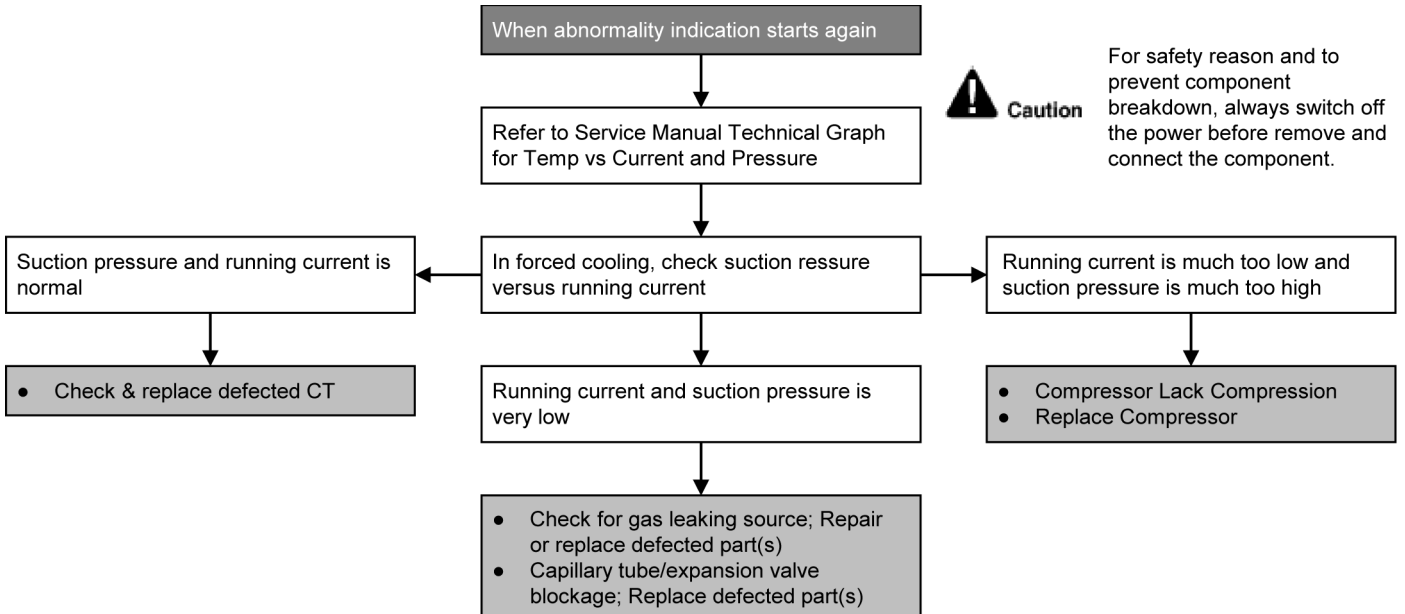

18.4.6 H19 (Indoor Fan Motor – DC Motor Mechanism Locked)

Malfunction Decision Conditions

- The rotation speed detected by the Hall IC during fan motor operation is used to determine abnormal fan motor (feedback of rotation > 2550 rpm or < 50 rpm)

Malfunction Caused

- Operation stops due to short circuit inside the fan motor winding.
- Operation stops due to breaking of wire inside the fan motor.
- Operation stops due to breaking of fan motor lead wires.
- Operation stops due to Hall IC malfunction.
- Operation error due to faulty indoor unit PCB.

Troubleshooting

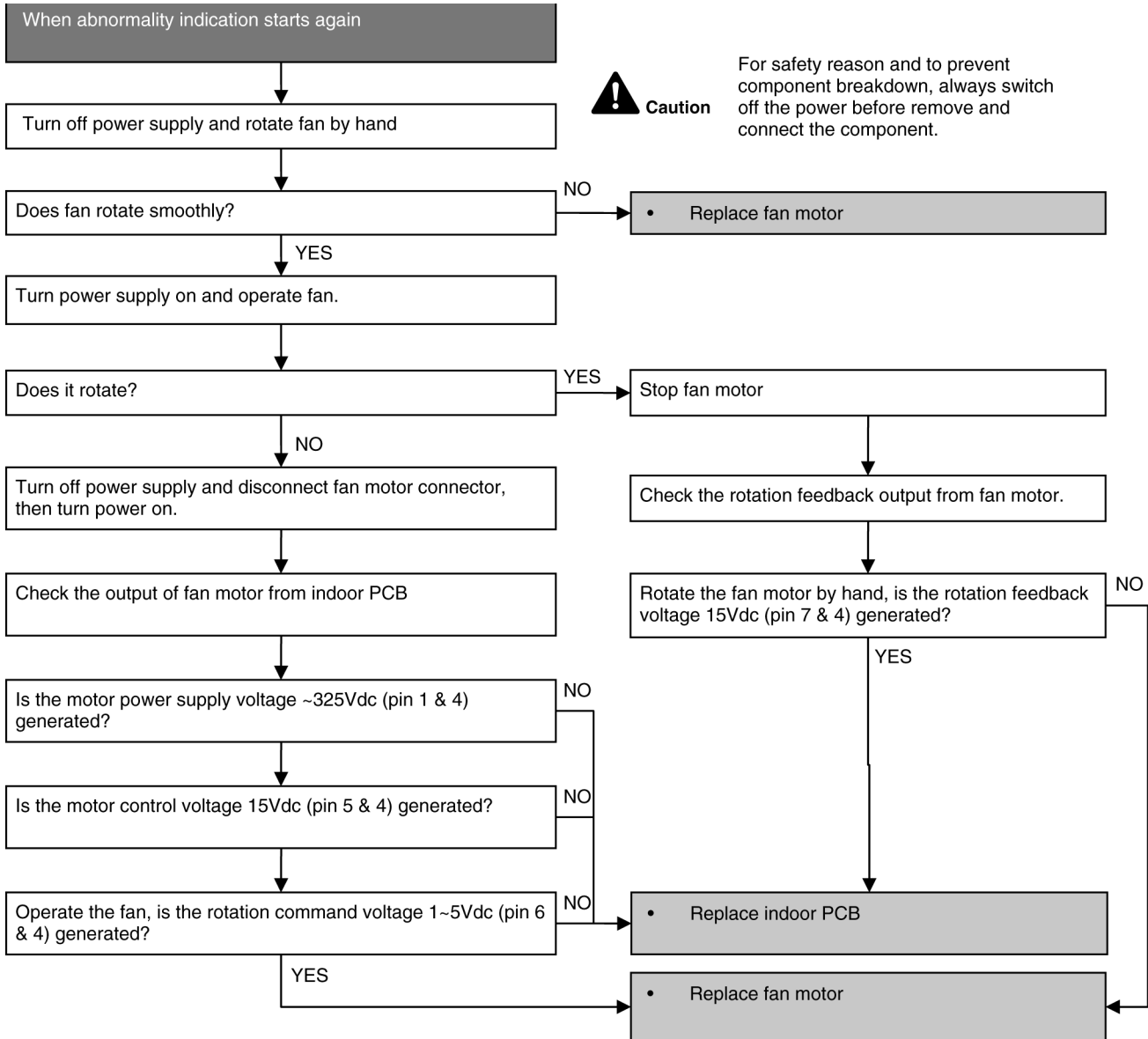

18.4.7 H23 (Indoor Pipe Temperature Sensor Abnormality)

Malfunction Decision Conditions

- During startup and operation of cooling and heating, the temperatures detected by the indoor heat exchanger temperature sensor are used to determine sensor errors.

Malfunction Caused

- Faulty connector connection.
- Faulty sensor.
- Faulty PCB.

Troubleshooting

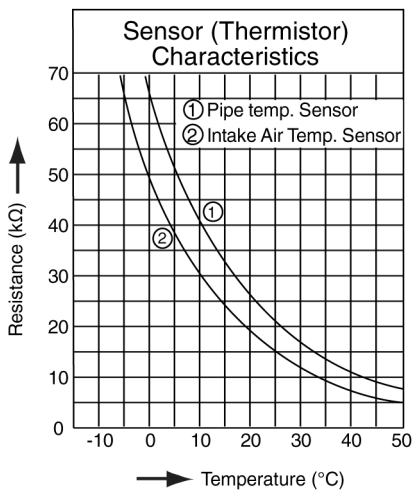
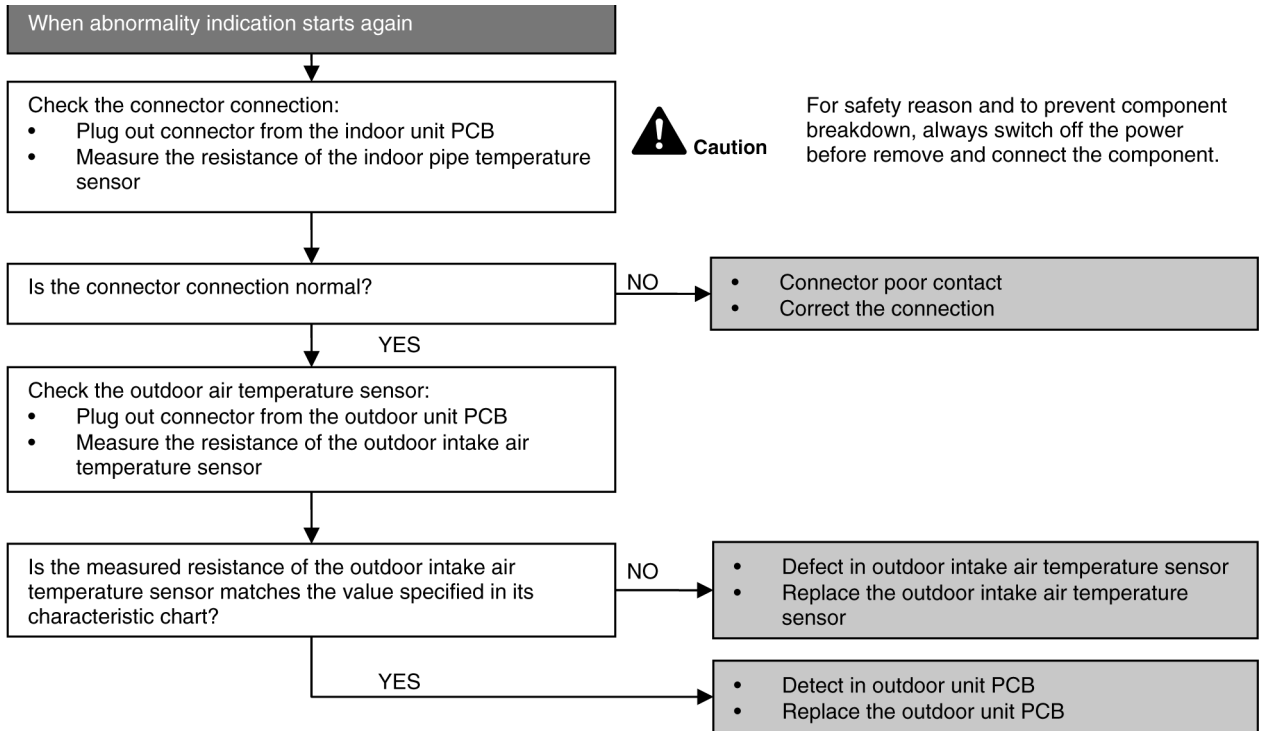

18.4.8 H24 (Indoor Pipe Temperature Sensor 2 Abnormality)

Malfunction Decision Conditions

- During startup and operation of cooling and heating, the temperatures detected by the indoor heat exchanger temperature sensor 2 are used to determine sensor errors.

Malfunction Caused

- Faulty connector connection.
- Faulty sensor.
- Faulty PCB.

Troubleshooting

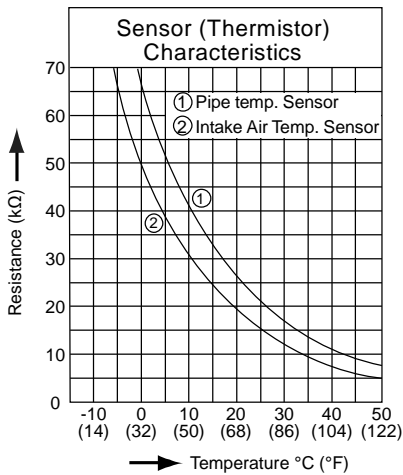
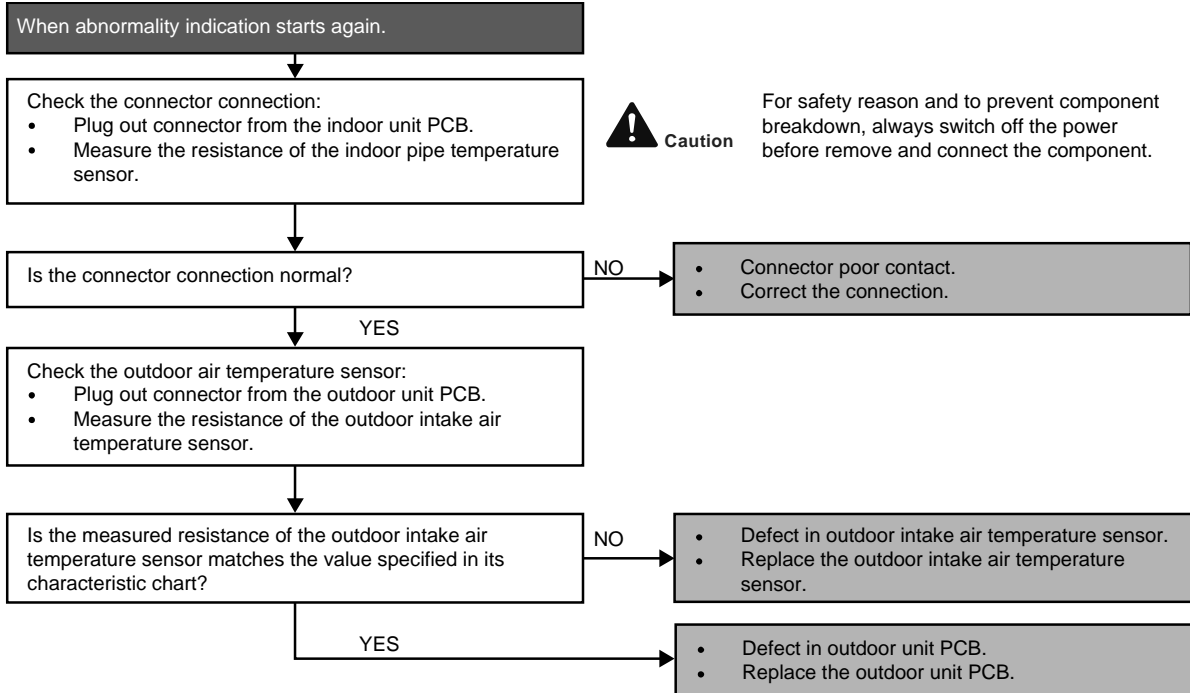

18.4.9 H27 (Outdoor Air Temperature Sensor Abnormality)

Malfunction Decision Conditions

- During startup and operation of cooling and heating, the temperatures detected by the outdoor air temperature sensor are used to determine sensor errors.

Malfunction Caused

- Faulty connector connection.
- Faulty sensor.
- Faulty PCB.

Troubleshooting

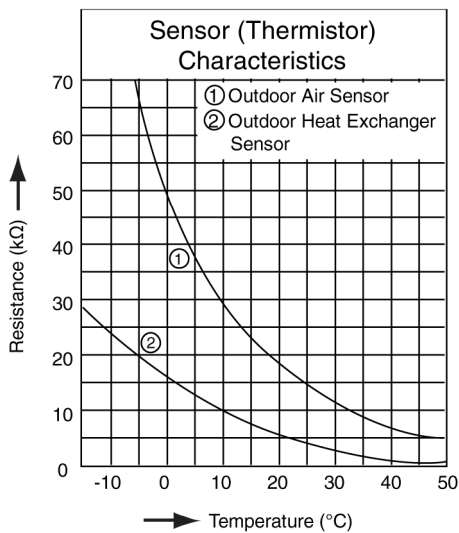
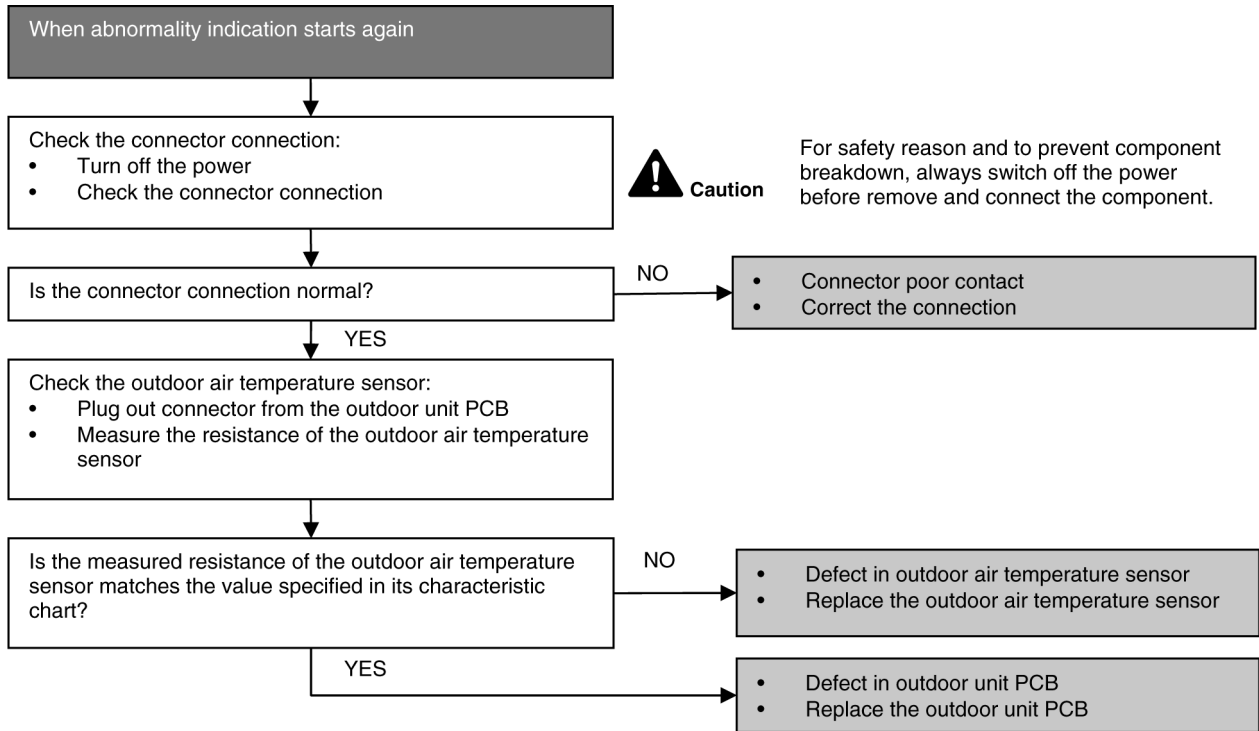

18.4.10 H28 (Outdoor Pipe Temperature Sensor Abnormality)

Malfunction Decision Conditions

- During startup and operation of cooling and heating, the temperatures detected by the outdoor pipe temperature sensor are used to determine sensor errors.

Malfunction Caused

- Faulty connector connection.
- Faulty sensor.
- Faulty PCB.

Troubleshooting

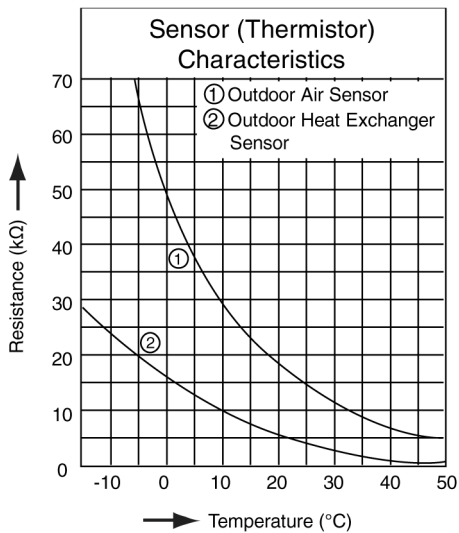
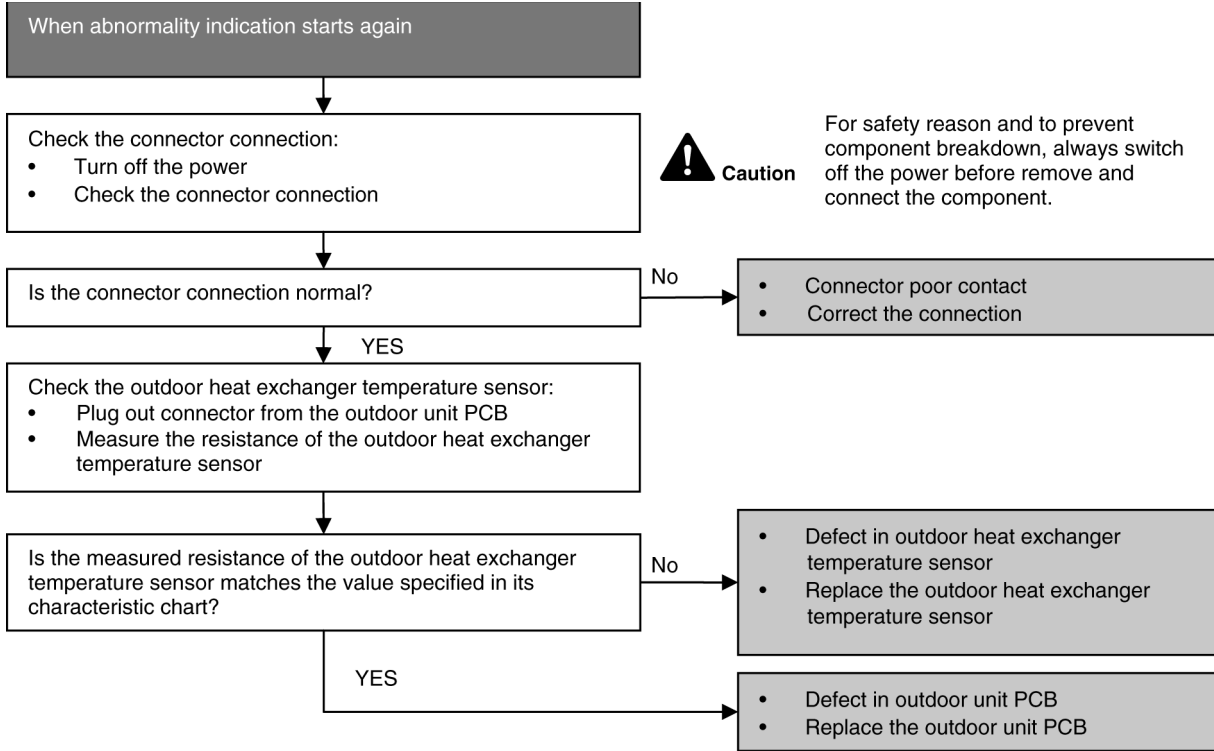

18.4.11 H30 (Compressor Discharge Temperature Sensor Abnormality)

Malfunction Decision Conditions

- During startup and operation of cooling and heating, the temperatures detected by the outdoor discharge pipe temperature sensor are used to determine sensor errors.

Malfunction Caused

- Faulty connector connection.
- Faulty sensor.
- Faulty PCB.

Troubleshooting

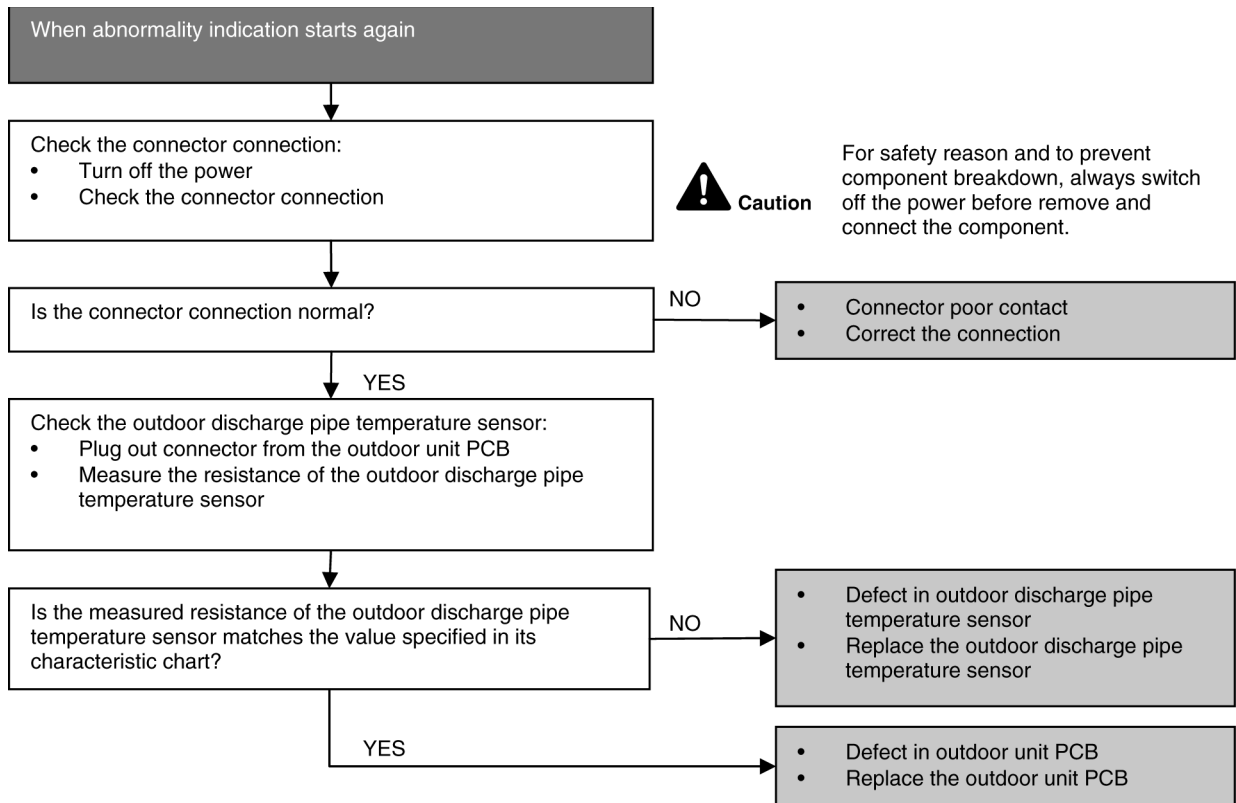

18.4.12 H32 (Outdoor Heat Exchanger Temperature Sensor 2 Abnormality)

Malfunction Decision Conditions

- During startup and operation of cooling and heating, the temperatures detected by the outdoor heat exchanger temperature sensor are used to determine sensor errors.

Malfunction Caused

- Faulty connector connection.
- Faulty sensor.
- Faulty PCB.

Troubleshooting

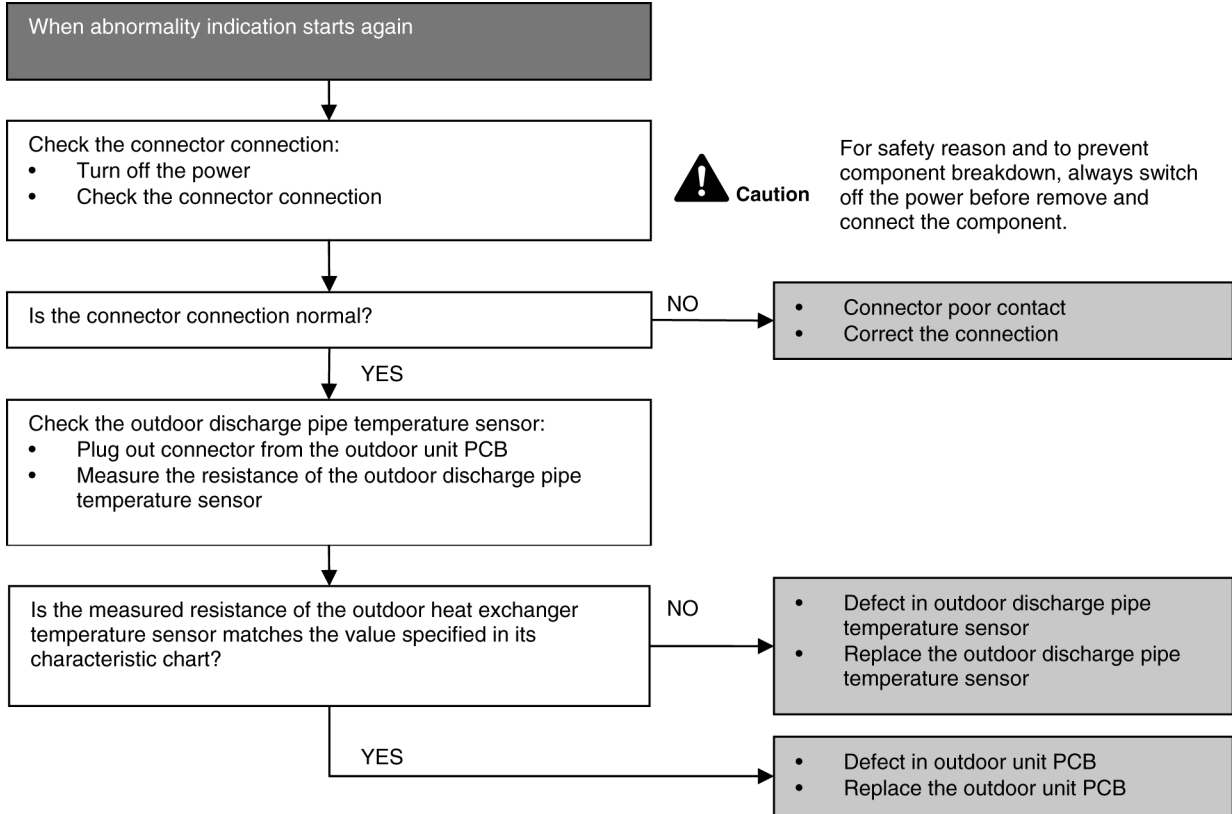

18.4.13 H33 (Unspecified Voltage between Indoor and Outdoor)

Malfunction Decision Conditions

- The supply power is detected for its requirement by the indoor/outdoor transmission.

Malfunction Caused

- Wrong models interconnected.
- Wrong indoor unit and outdoor unit PCBs used.
- Indoor unit or outdoor unit PCB defective.

Troubleshooting

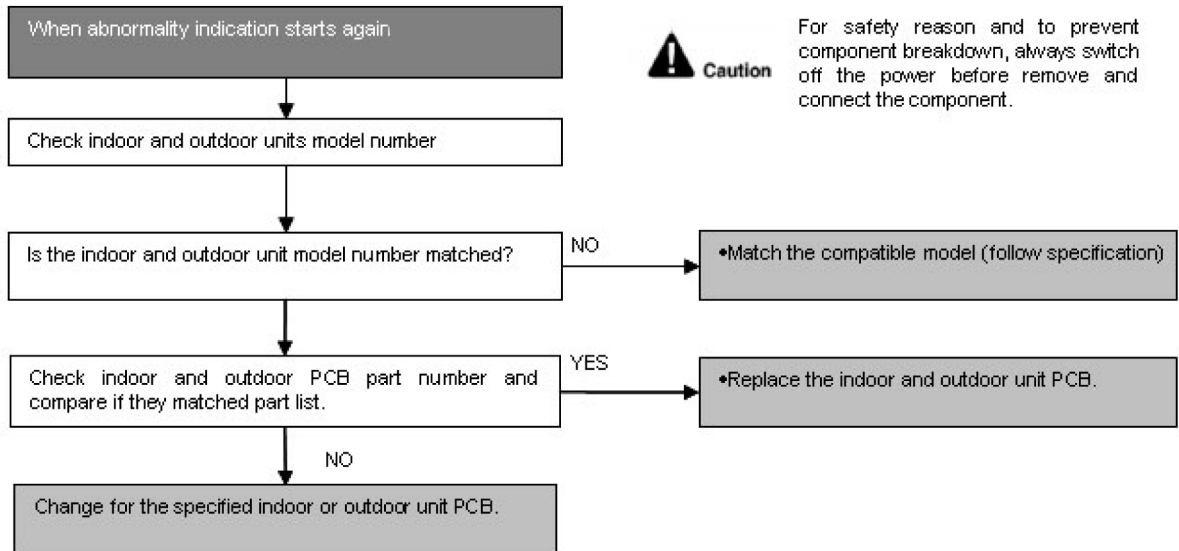

18.4.14 H36 (Outdoor Gas Pipe Sensor Abnormality)

Malfunction Decision Conditions

- During startup and operation of cooling and heating, the temperatures detected by the outdoor gas pipe temperature sensor are used to determine sensor errors.

Malfunction Caused

- Faulty connector connection.
- Faulty sensor.
- Faulty PCB.

Troubleshooting

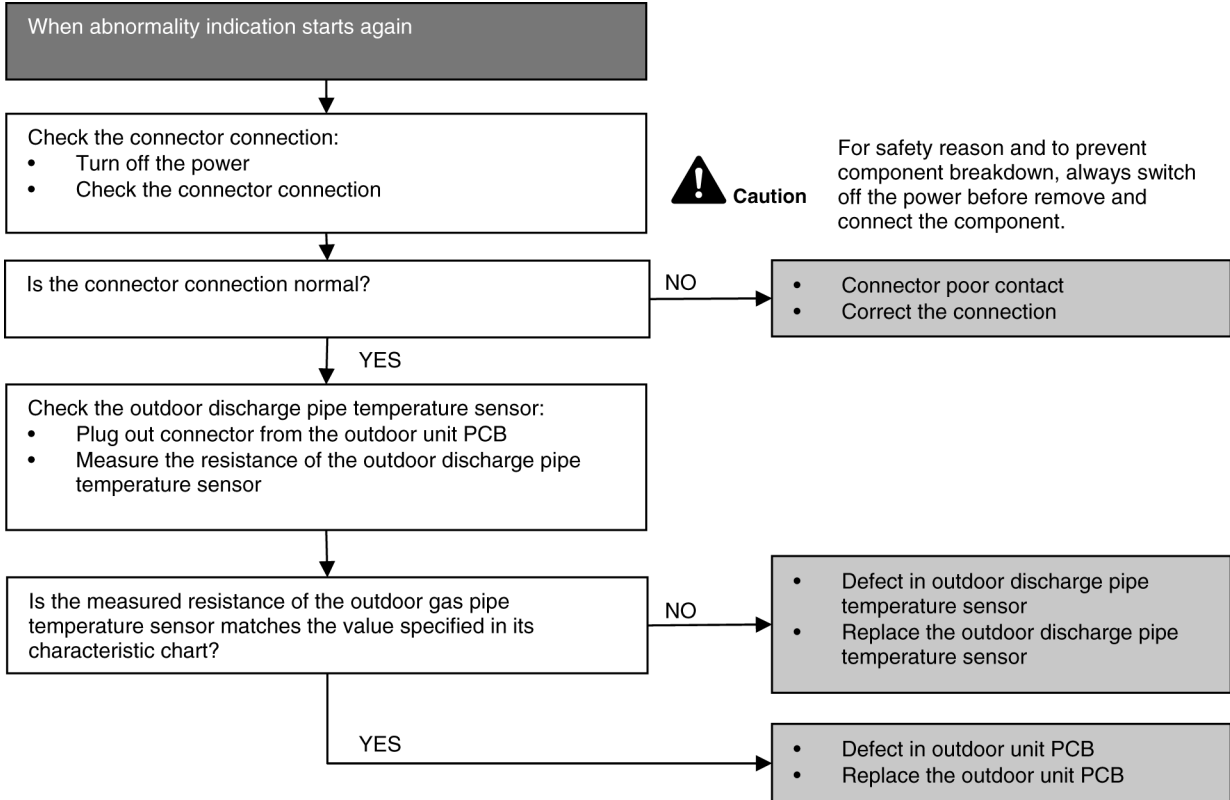

18.4.15 H37 (Outdoor Liquid Pipe Temperature Sensor Abnormality)

Malfunction Decision Conditions

- During startup and operation of cooling and heating, the temperatures detected by the outdoor liquid pipe temperature sensor are used to determine sensor errors.

Malfunction Caused

- Faulty connector connection.
- Faulty sensor.
- Faulty PCB.

Troubleshooting

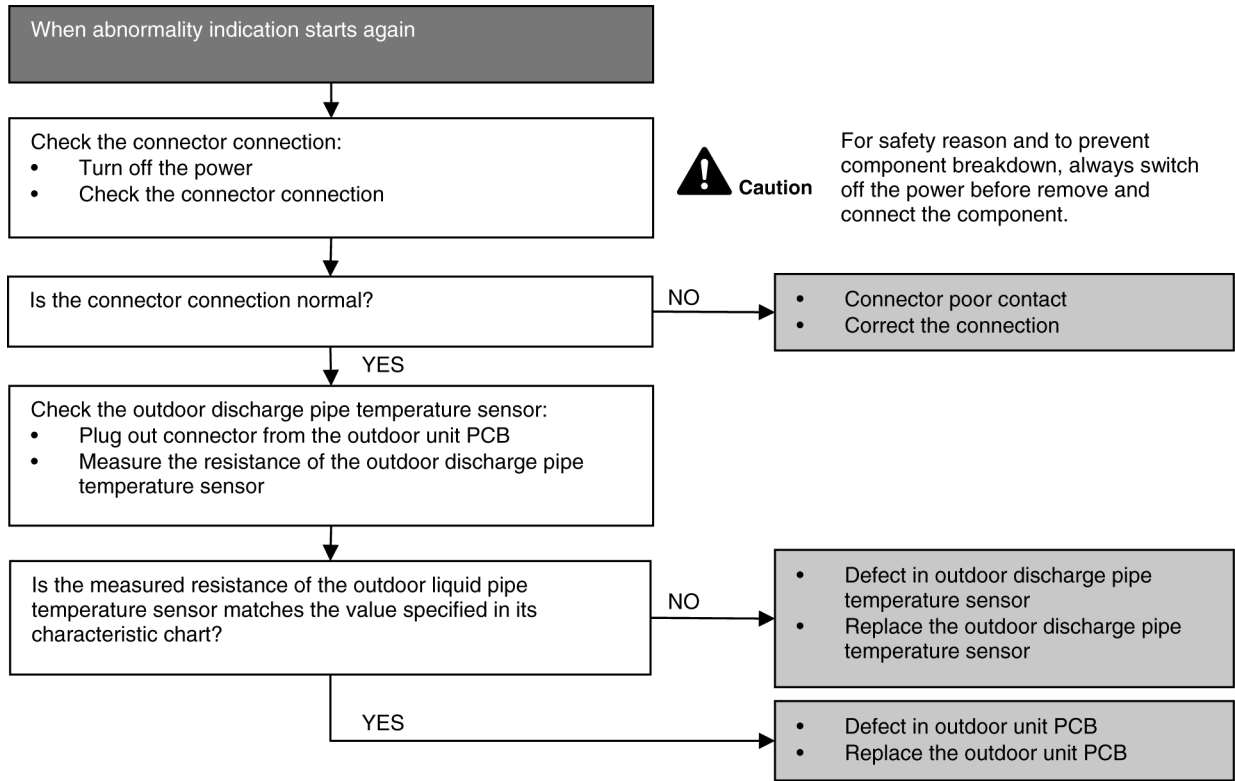

18.4.16 H97 (Outdoor Fan Motor – DC Motor Mechanism Locked)

Malfunction Decision Conditions

- The rotation speed detected by the Hall IC during fan motor operation is used to determine abnormal fan motor.

Malfunction Caused

- Operation stops due to short circuit inside the fan motor winding.
- Operation stops due to breaking of wire inside the fan motor.
- Operation stops due to breaking of fan motor lead wires.
- Operation stops due to Hall IC malfunction.
- Operation error due to faulty outdoor unit PCB.

Troubleshooting

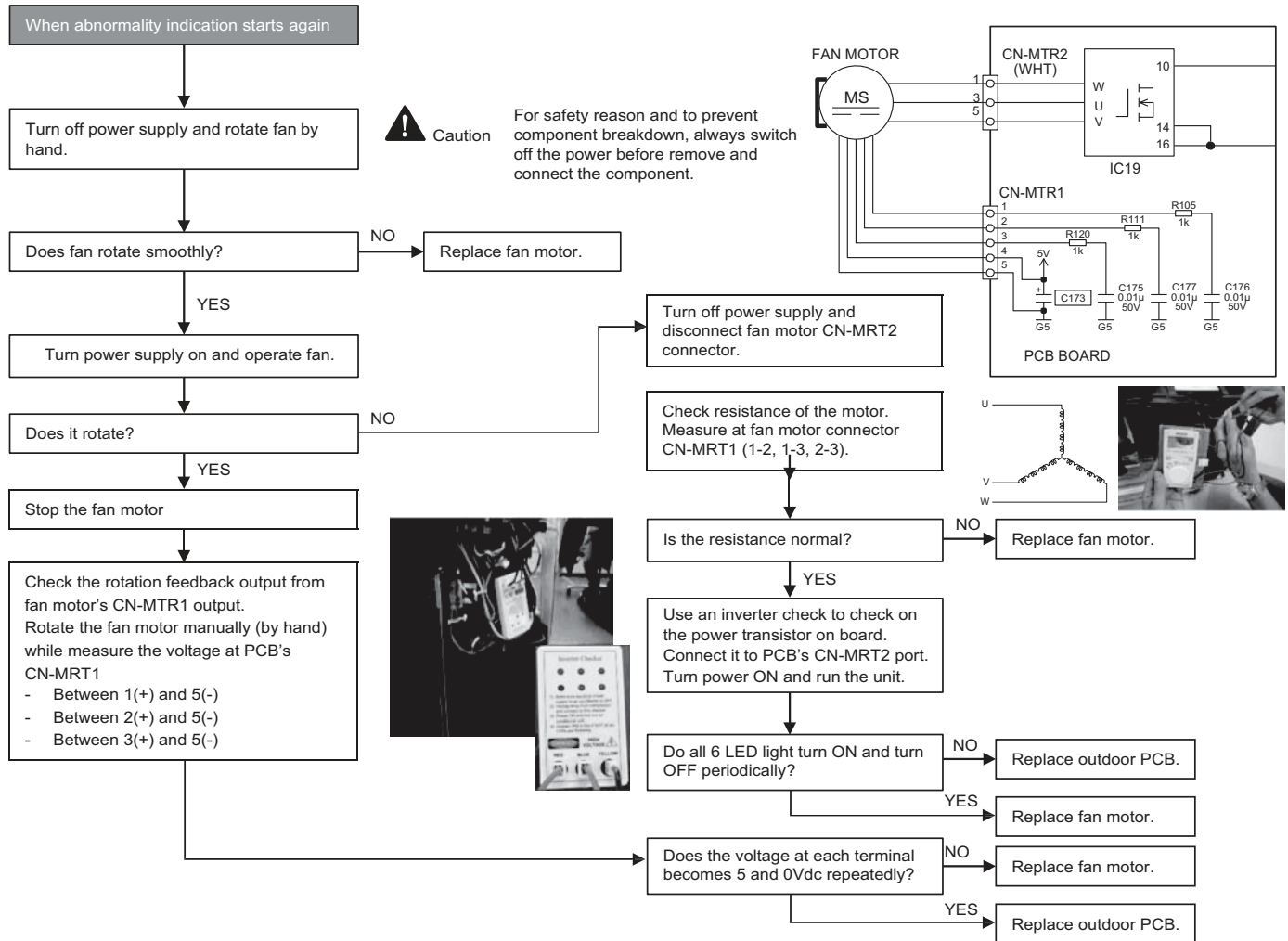

18.4.17 H98 (Error Code Stored in Memory and no alarm is triggered / no TIMER LED flashing)

Malfunction Decision Conditions

- Indoor high pressure is detected when indoor heat exchanger is detecting very high temperature when the unit is operating in heating operation.
- Phenomena: unit is stopping and re-starting very often in heating mode

Malfunction Caused

- Indoor heat exchanger thermistor
- Clogged air filter or heat exchanger
- Over-bent pipe (liquid side)

Troubleshooting

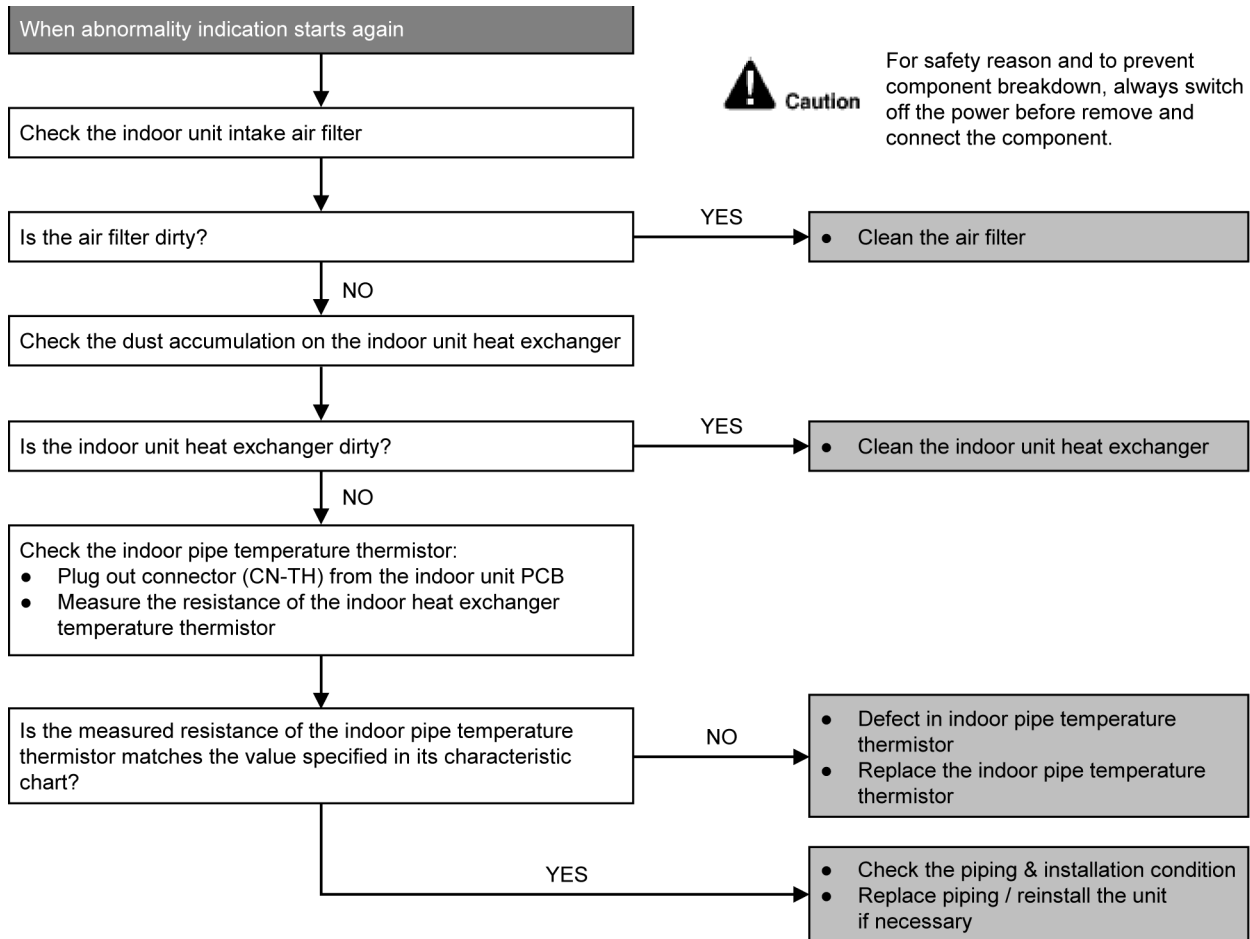

18.4.18 H99 (Indoor Freeze Prevention Protection: Cooling or Soft Dry)

Error Code will not display (no Timer LED blinking) but store in EEPROM

Malfunction Decision Conditions

- Freeze prevention control takes place (when indoor pipe temperature is lower than 2°C)

Malfunction Caused

- Air short circuit at indoor unit
- Clogged indoor unit air filter
- Dust accumulation on the indoor unit heat exchanger
- 2/3 way valve closed
- Faulty indoor unit fan motor
- Refrigerant shortage (refrigerant leakage)
- Clogged expansion valve or strainer
- Faulty indoor pipe temperature sensor
- Faulty indoor unit PCB

Troubleshooting

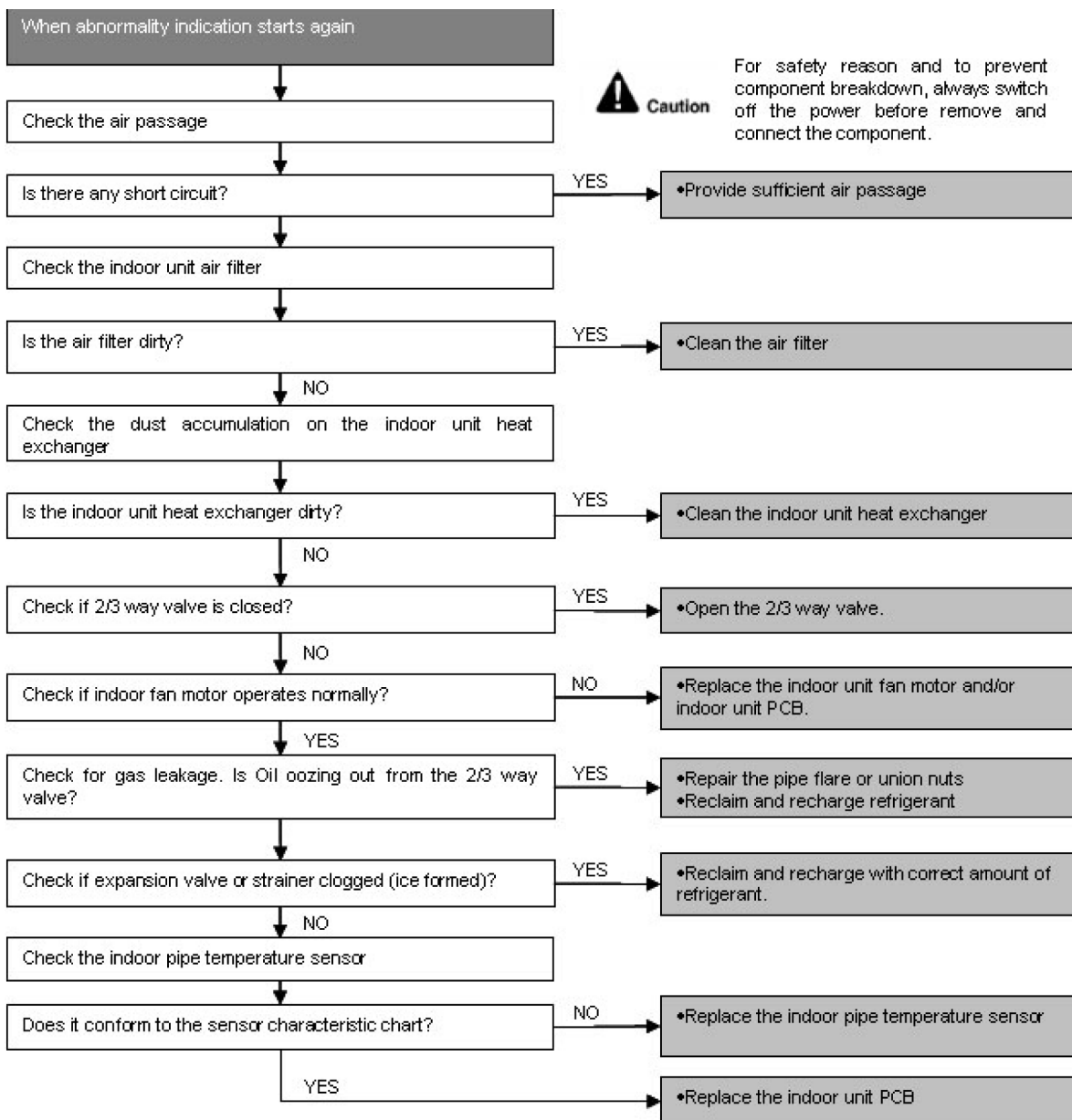

18.4.19 F11 (4-way Valve Switching Failure)

Malfunction Decision Conditions

- When indoor heat exchanger is cold during heating (except deice) or when indoor heat exchanger is hot during cooling and compressor operating, the 4-way valve is detected as malfunction.

Malfunction Caused

- Indoor heat exchanger (pipe) thermistor
- 4-way valve malfunction

Troubleshooting

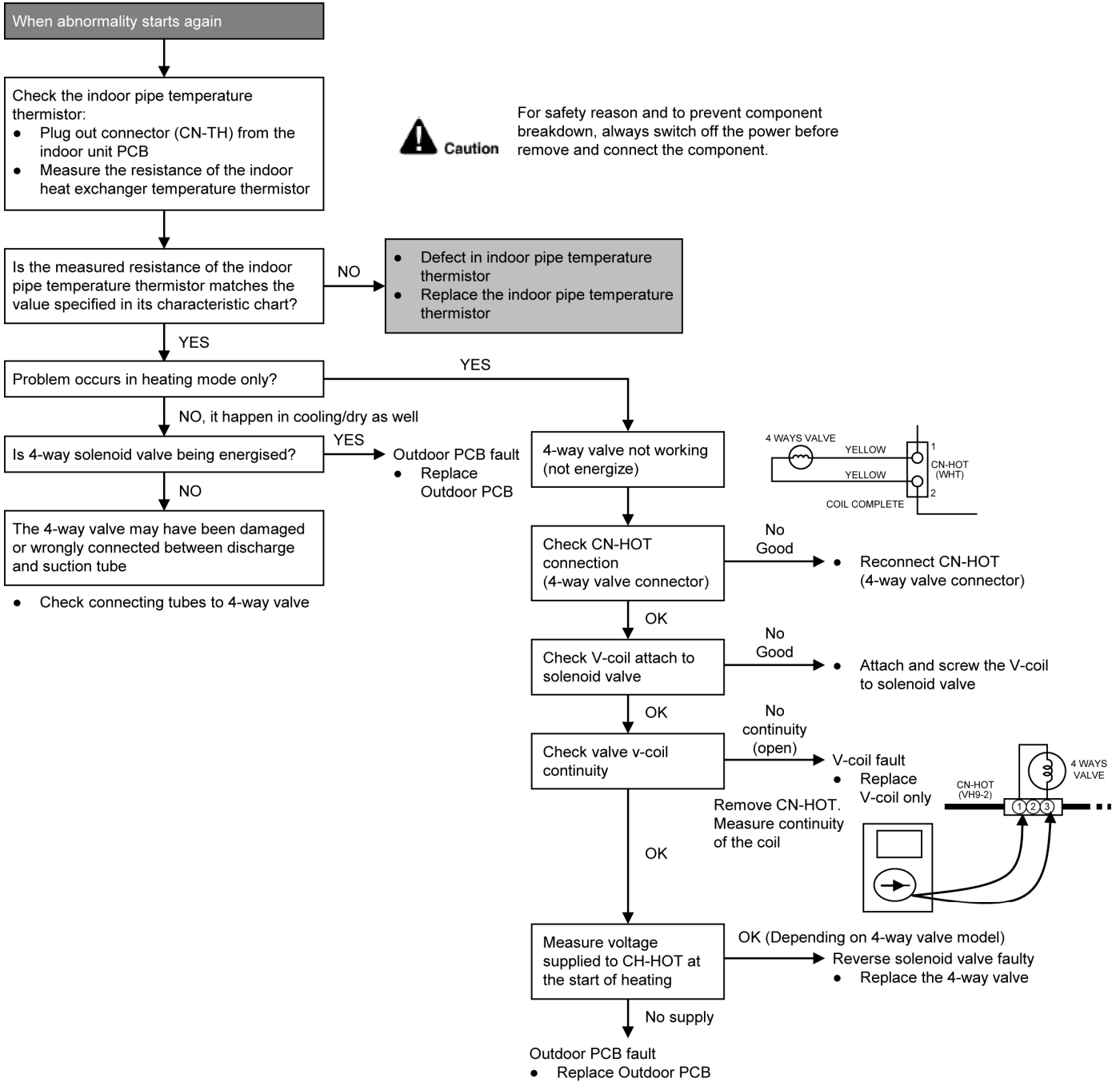

* Check gas side pipe – for hot gas flow in cooling mode

18.4.20 F17 (Indoor Standby Units Freezing Abnormality)

Malfunction Decision Conditions

- When the different between indoor intake air temperature and indoor pipe temperature is above 10°C or indoor pipe temperature is below -1.0°C.

Remark:

When the indoor standby unit is freezing, the outdoor unit transfers F17 error code to the corresponding indoor unit and H39 to other indoor unit(s).

Malfunction Caused

- Wrong wiring connection
- Faulty sensor
- Faulty expansion valve

Troubleshooting

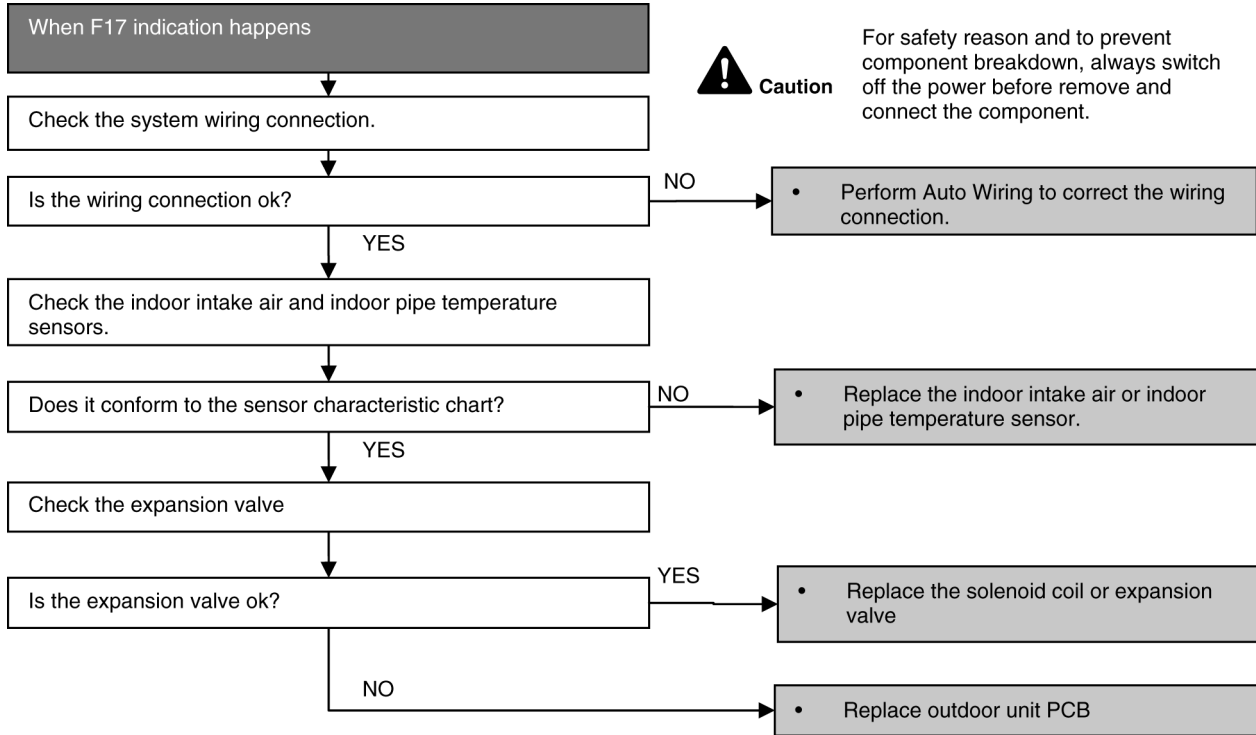

18.4.21 F90 (Power Factor Correction Protection)

Malfunction Decision Conditions

- To maintain DC voltage level supply to power transistor.
- To detect high DC voltage level after rectification.

Malfunction Caused

- During startup and operation of cooling and heating, when Power Factor Correction (PFC) protection circuitry at the outdoor unit main PCB senses abnormal DC voltage level for power transistors.
- When DC voltage detected is LOW, transistor switching will turn ON by controller to push-up the DC level.
- When DC voltage detected is HIGH (391Vdc – 425Vdc), active LOW signal will send by the controller to turn OFF relay RY-C.

Troubleshooting

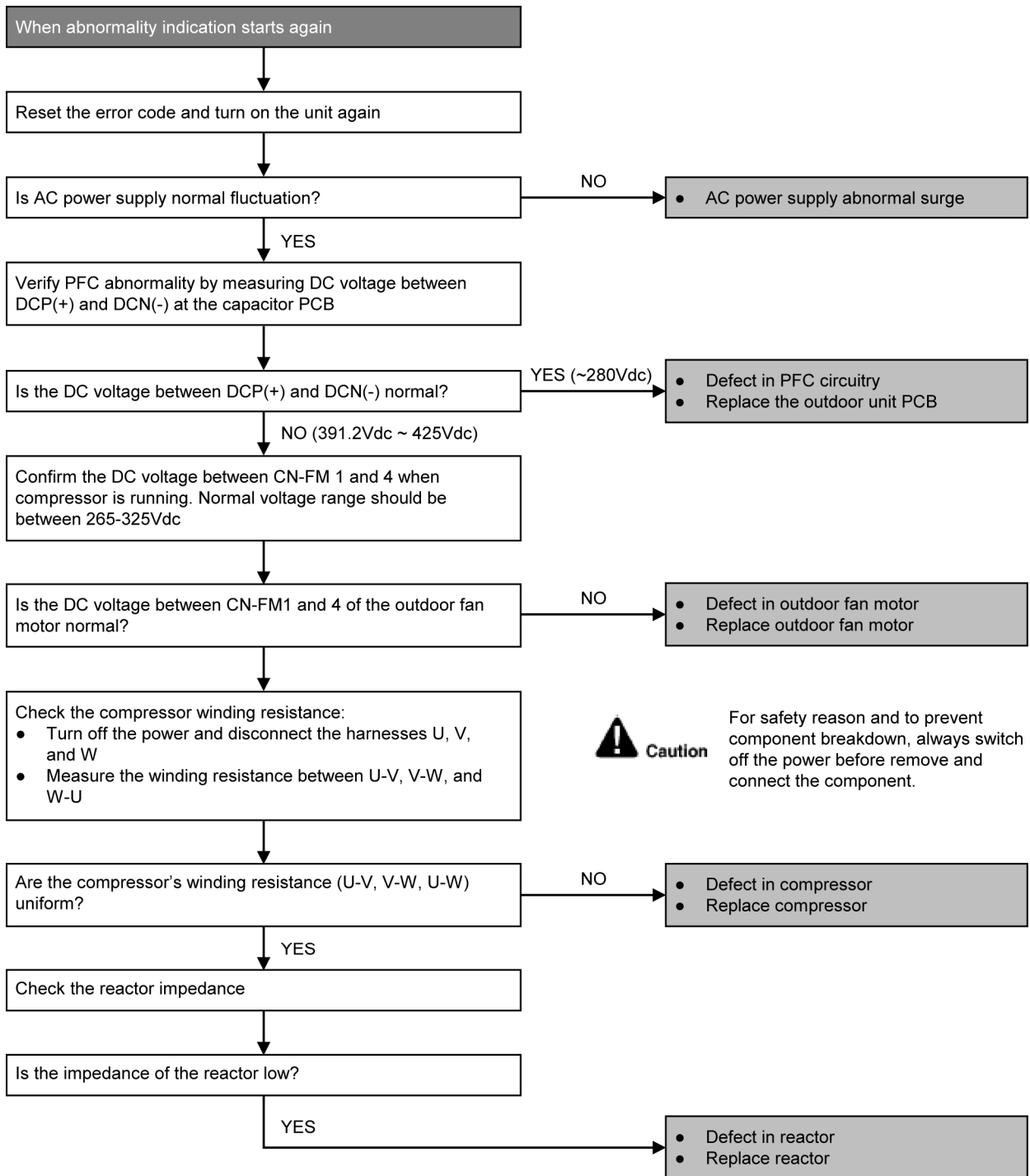

18.4.22 F91 (Refrigeration Cycle Abnormality)

Malfunction Decision Conditions

- The input current is low while the compressor is running at higher than the setting frequency.

Malfunction Caused

- Lack of gas.
- 3-way valve close.

Troubleshooting

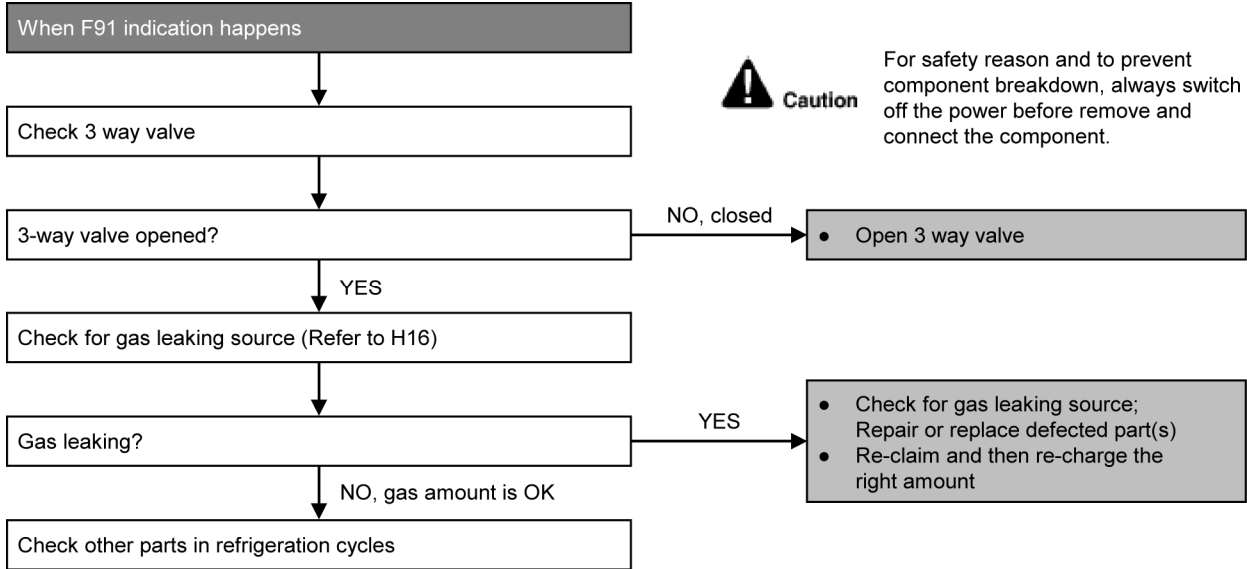

18.4.23 F93 (Compressor Rotation Failure)

Malfunction Decision Conditions

- A compressor rotation failure is detected by checking the compressor running condition through the position detection circuit.

Malfunction Caused

- Compressor terminal disconnect
- Faulty Outdoor PCB
- Faulty compressor

Troubleshooting

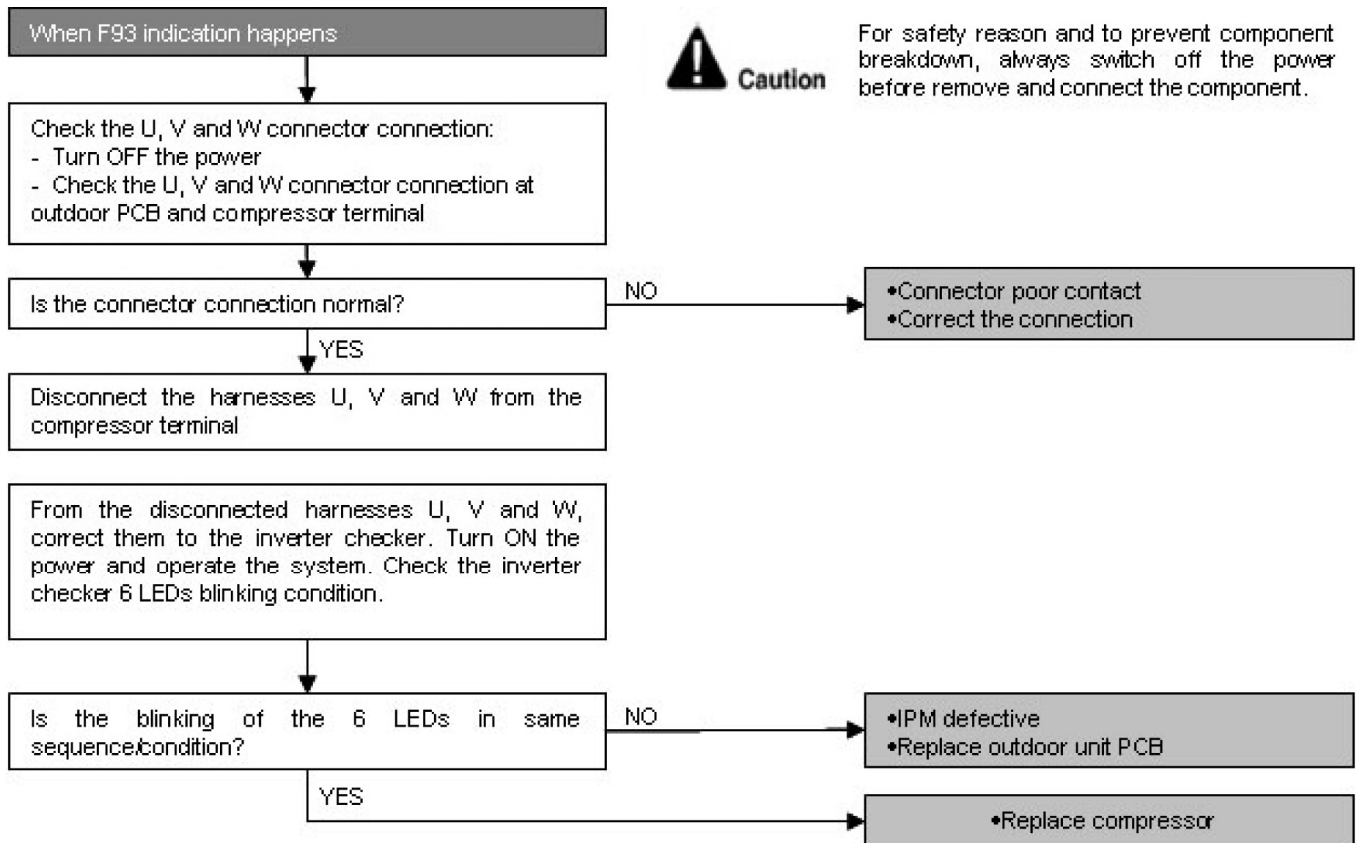

18.4.24 F95 (Outdoor High Pressure Protection: Cooling or Soft Dry)

Malfunction Decision Conditions

- During operation of cooling or soft dry, when outdoor unit heat exchanger high temperature data is detected by the outdoor unit heat exchanger thermistor.

Malfunction Caused

- Outdoor heat exchanger temperature rise due to short-circuit of hot discharge air flow.
- Outdoor heat exchanger temperature rise due to defective of outdoor fan motor.
- Outdoor heat exchange temperature rise due to defective outdoor heat exchanger thermistor.
- Outdoor heat exchanger temperature rise due to defective of outdoor unit PCB.

Troubleshooting

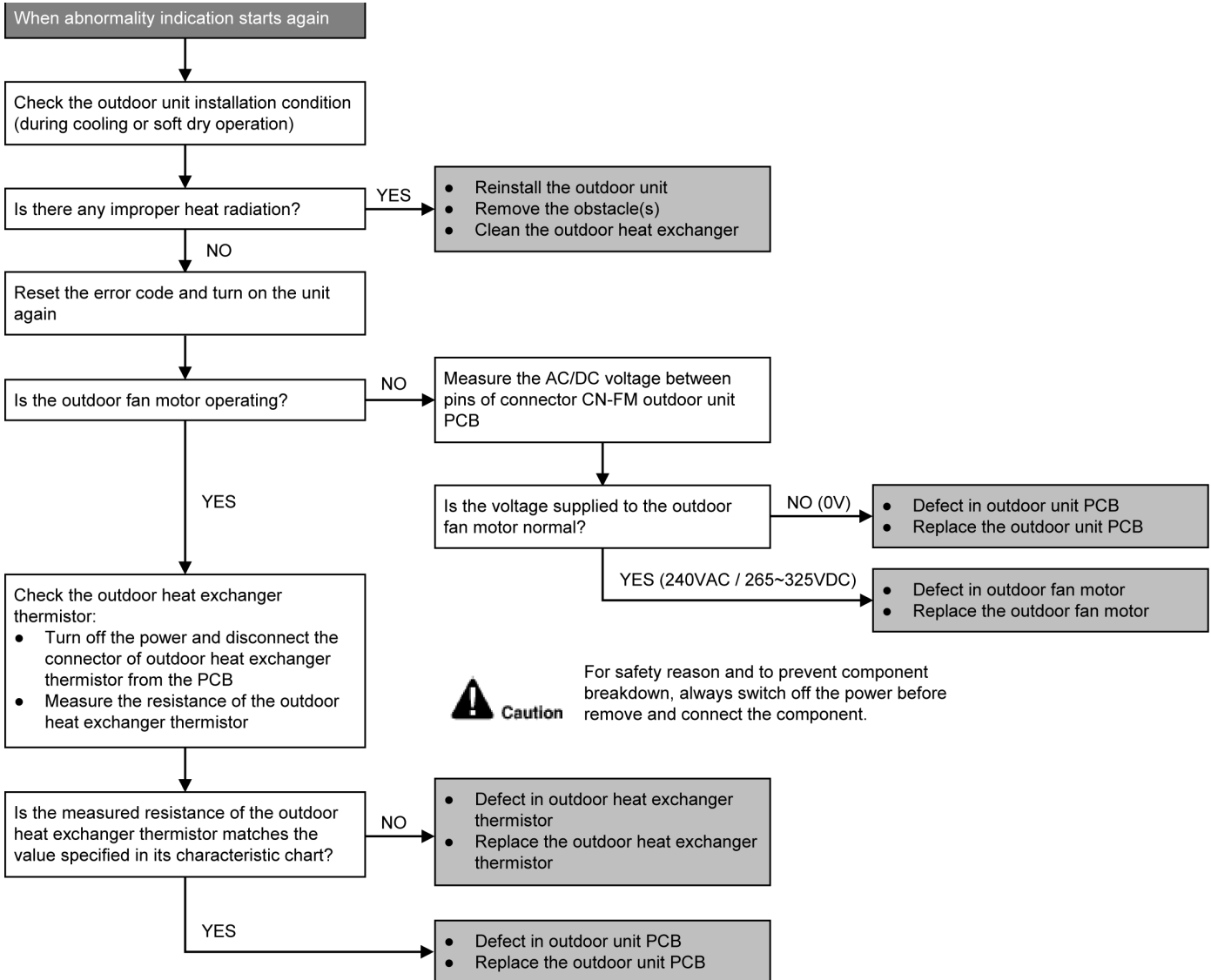

18.4.25 F96 (IPM Overheating)

Malfunction Decision Conditions

- During operating of cooling and heating, when IPM temperature data (100°C) is detected by the IPM temperature sensor.

Multi Models only

- Compressor Overheating: During operation of cooling and heating, when the compressor OL is activated.
- Heat Sink Overheating: During operation of cooling and heating, when heat sink temperature data (90°C) is detected by the heat sink temperature sensor.

Malfunction Caused

- IPM overheats due to short circuit of hot discharge air flow.
- IPM overheats due to defective of outdoor fan motor.
- IPM overheats due to defective of internal circuitry of IPM.
- IPM overheats due to defective IPM temperature sensor.

Multi Models Only

- Compressor OL connector poor contact.
- Compressor OL faulty.

Troubleshooting

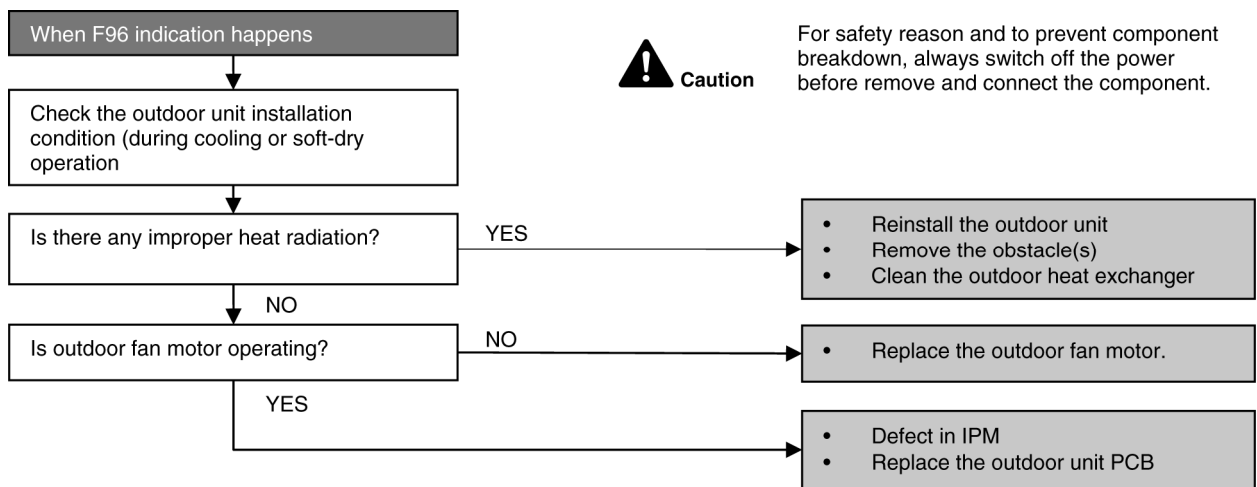

18.4.26 F97 (Compressor Overheating)

Malfunction Decision Conditions

- During operation of cooling and heating, when compressor tank temperature data (112°C) is detected by the compressor tank temperature sensor.

Malfunction Caused

- Faulty compressor tank temperature sensor
- 2/3 way valve closed
- Refrigerant shortage (refrigerant leakage)
- Faulty outdoor unit PCB
- Faulty compressor

Troubleshooting

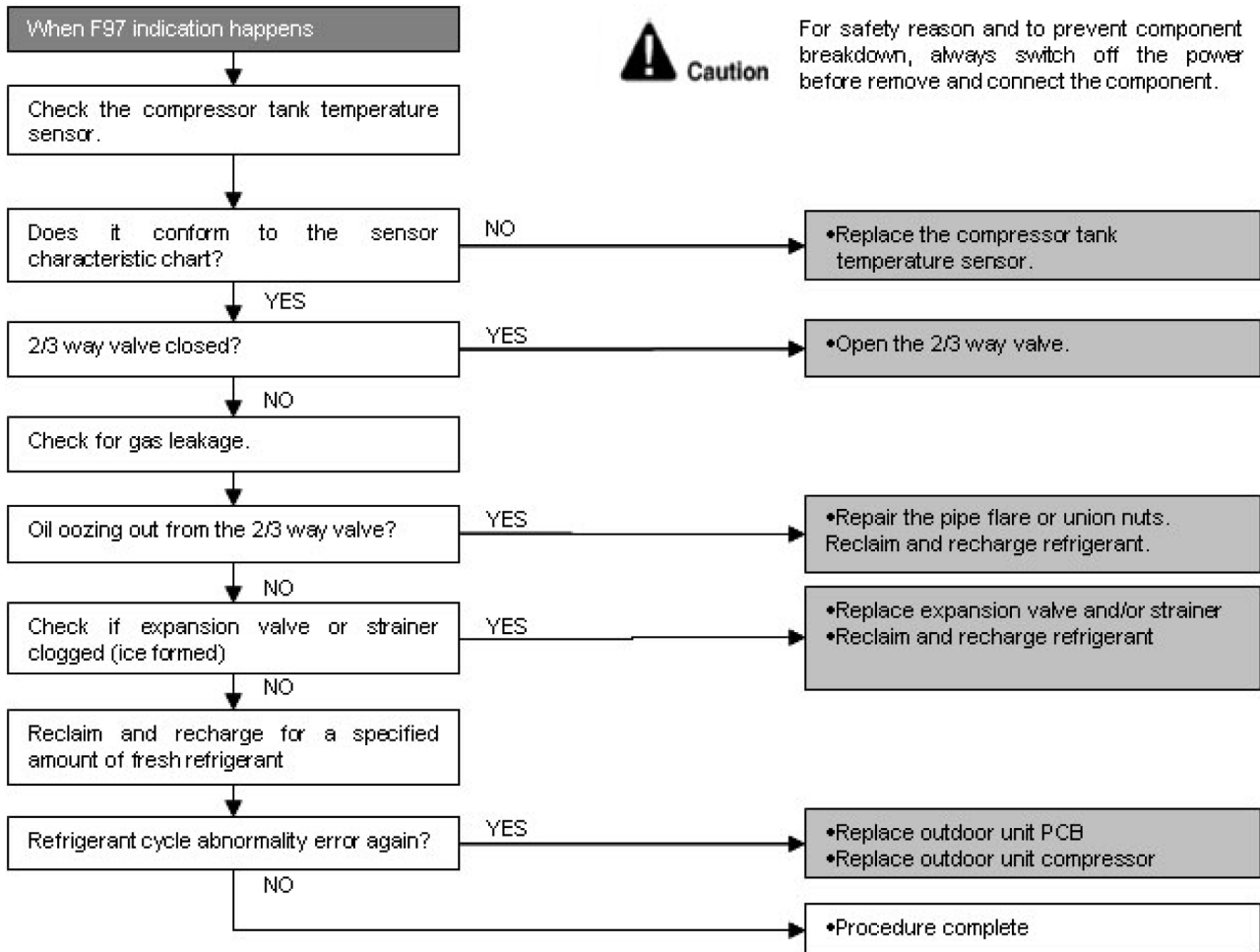

18.4.27 F98 (Input Over Current Detection)

Malfunction Decision Conditions

- During operation of cooling and heating, when an input over-current (X value in Total Running Current Control) is detected by checking the input current value being detected by current transformer (CT) with the compressor running.

Malfunction Caused

- Excessive refrigerant.
- Faulty outdoor unit PCB.

Troubleshooting

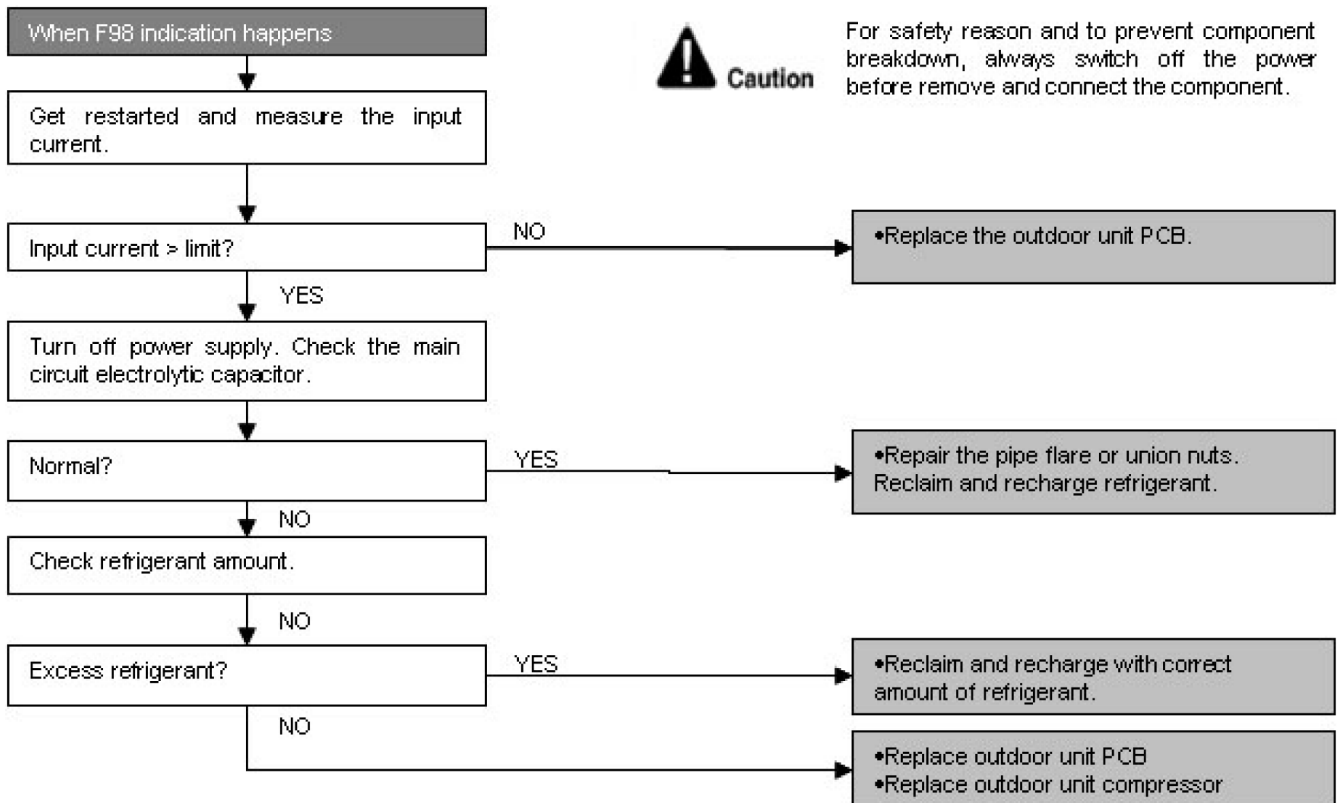

18.4.28 F99 (DC Peak Detection)

Malfunction Decision Conditions

During startup and operation of cooling and heating, when inverter DC peak data is received by the outdoor internal DC Peak sensing circuitry.

Malfunction Caused

- DC current peak due to compressor failure.
- DC current peak due to defective power transistor(s).
- DC current peak due to defective outdoor unit PCB.
- DC current peak due to short circuit.

Troubleshooting

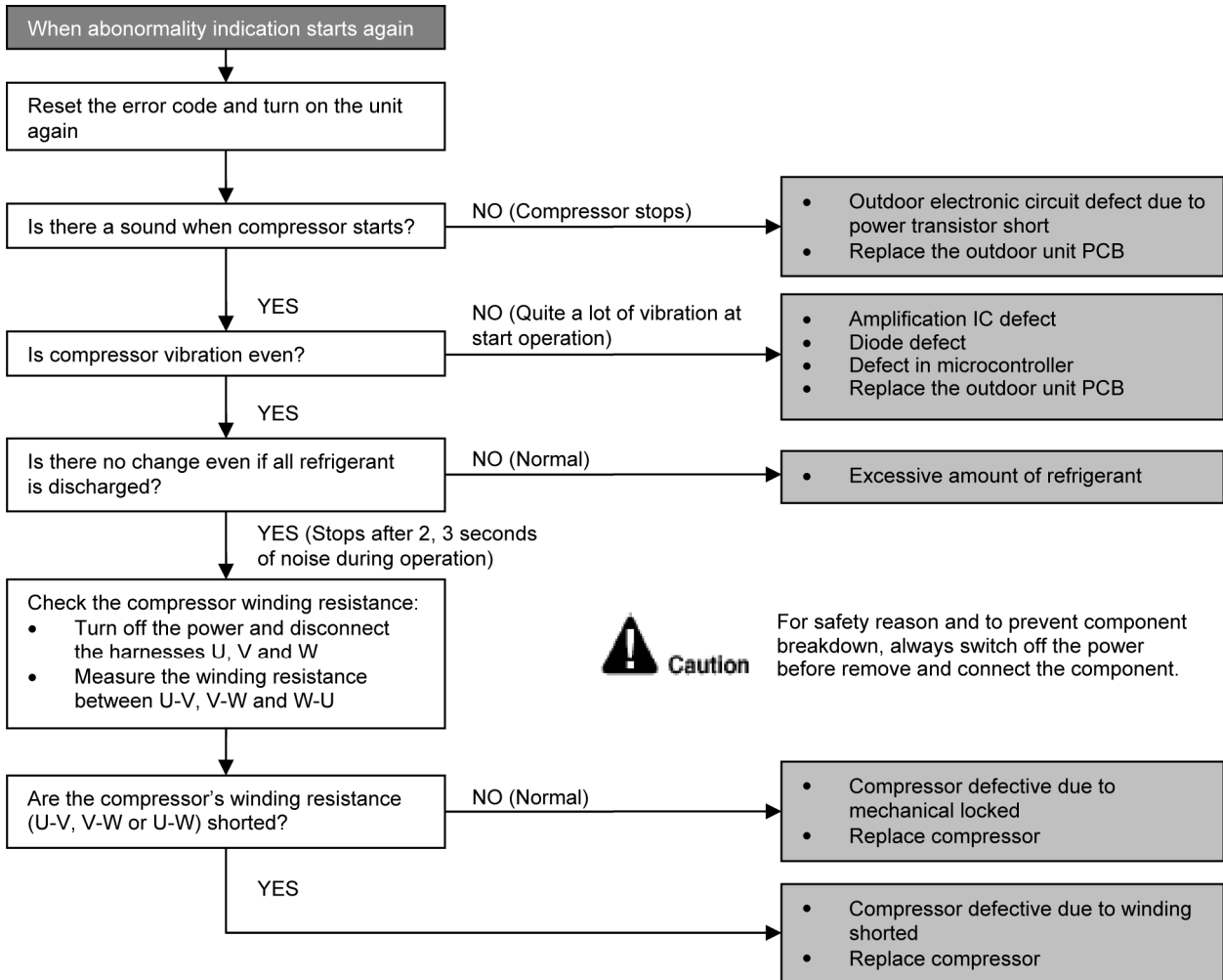

19. Disassembly and Assembly Instructions



WARNING

High Voltage is generated in the electrical parts area by the capacitor. Ensure that the capacitor has discharged sufficiently before proceeding with repair work. Failure to heed this caution may result in electric shocks.

19.1 Disassembly of Parts

- 1 Open the Intake Grille from the Front Grille by moving the catchers to center (Fig.1).

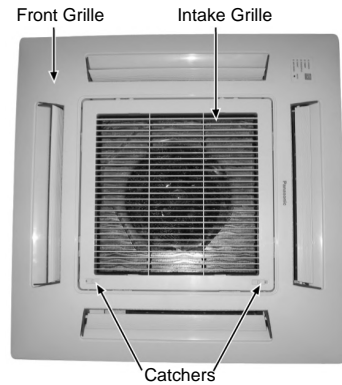

Fig. 1

- 2 Remove the Control Board Cover by removing the screws (Fig. 2).

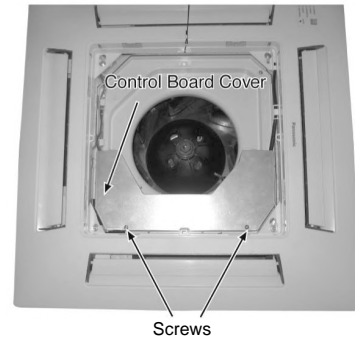

Fig. 2

- 3 Release the (Fig. 3):
 - CN-STM1 (WHT) connector.
 - CN-STM2 (YLV) connector.
 - CN-DISP (WHT) connector.
 - CN-FM (WHT) connector.
 - CN-TH1 (WHT) connector.
 - CN-TH2 (BLU) connector.
 - CN-DRMTR1 (BLU) connector.
 - AC01 (BLK), AC02 (WHT) and CN-DRMTR2 (RED) from Terminal Board.
 - G01 (GRN) screw.
 - Two T-BLK connectors.
 - CN-T1 (WHT).
 - CN-T2 (YLV).

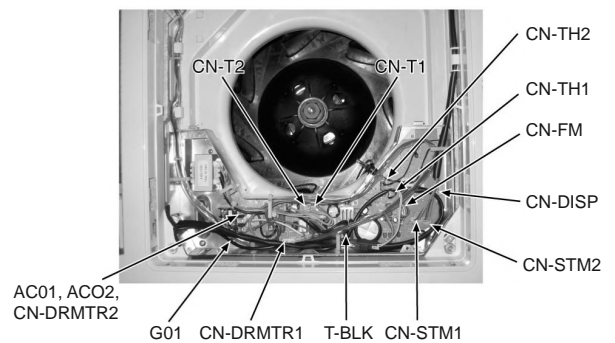

Fig. 3

- 4 To remove the Electronic Controller, release the 6 hooks that hold it to the Control Board (Fig. 4).

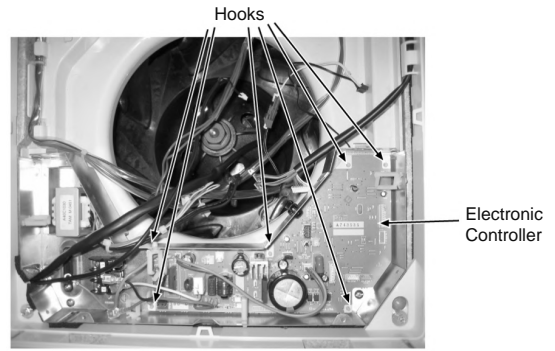

Fig. 4

- 5 Remove the Front Grille by removing the screw A and screws B, C & D half way open (Fig. 5).

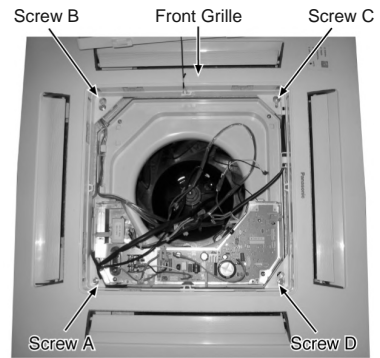

Fig. 5

- 6 Remove the Air Guider and Drain Pan complete by removing the screws (Fig. 6).

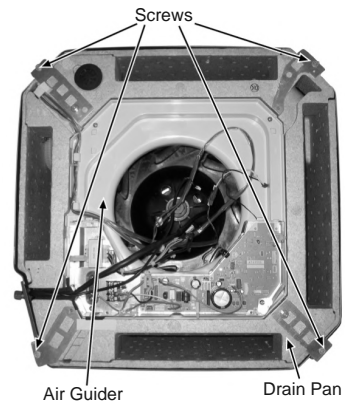

Fig. 6

- 7 Remove the Turbo Fan by removing the bolt (Fig. 7).

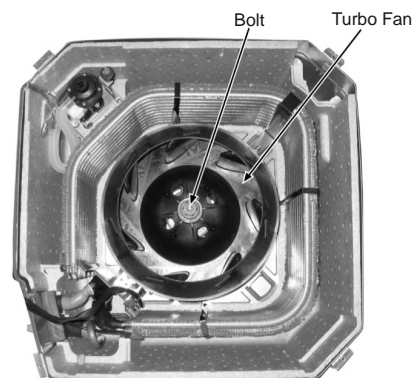

Fig. 7

- 8 Remove the Fan Motor by release the Fan Motor lead wire connectors and Fan Motor screws (Fig. 8).

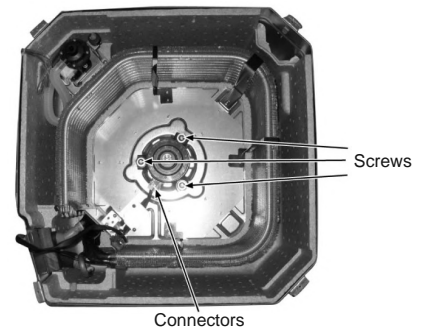

Fig. 8

19.2 Outdoor Electronic Controller Removal Procedure

19.2.1 CU-Z25UBEA

⚠ Caution! When handling electronic controller, be careful of electrostatic discharge.

- 1 Remove the 5 screws of the Top Panel.

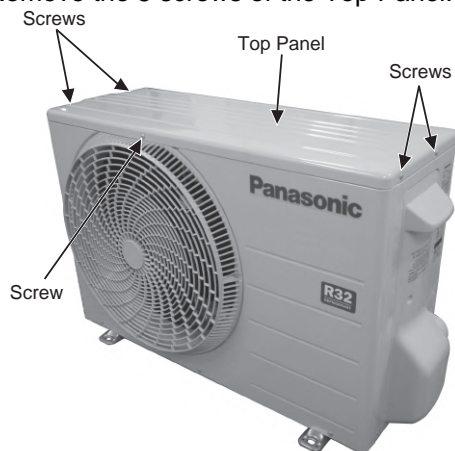

Fig. 1

- 2 Remove the 6 screws of the Front Panel.

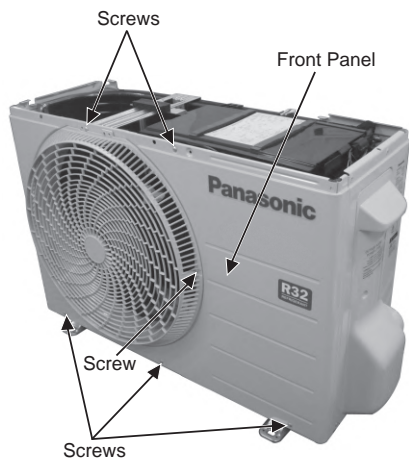

Fig. 2

- 3 Remove the screw of the Terminal Board Cover.

- 4 Remove the Top Cover of the Control Board by 4 hooks.

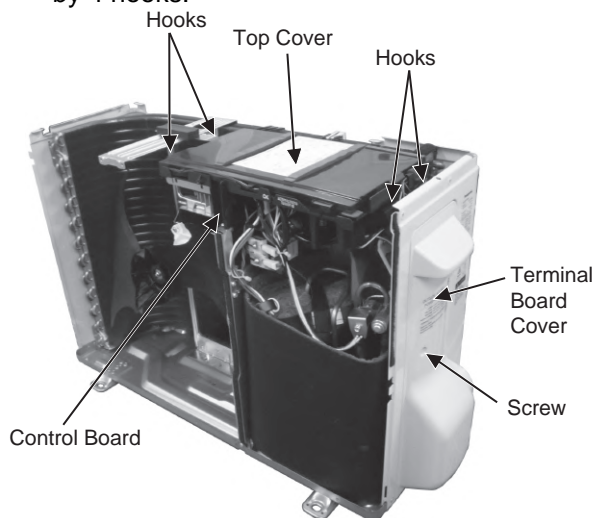

Fig. 3

- 5 Remove the Control Board as follows:

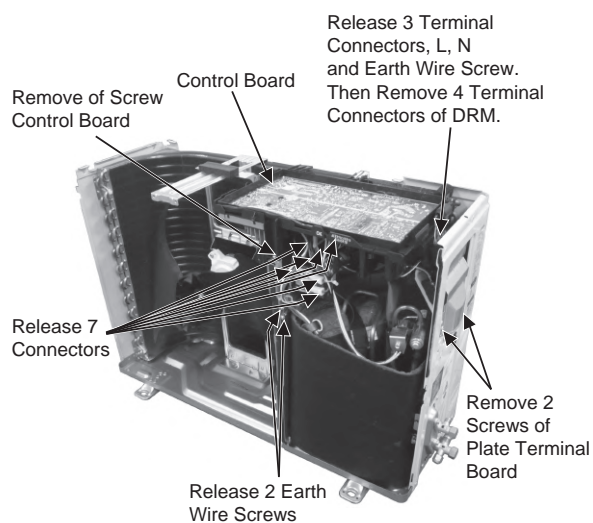

Fig. 4

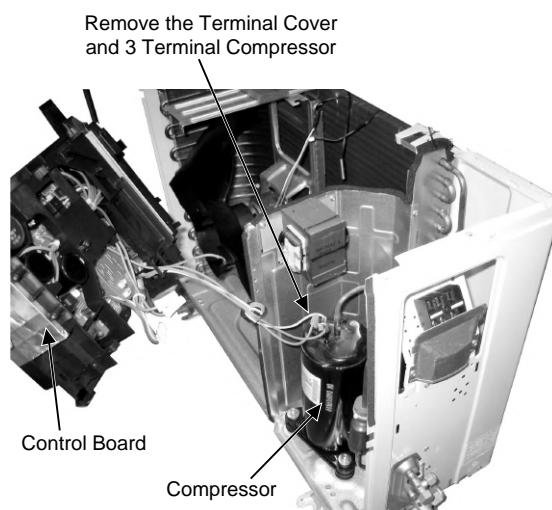

Fig. 5

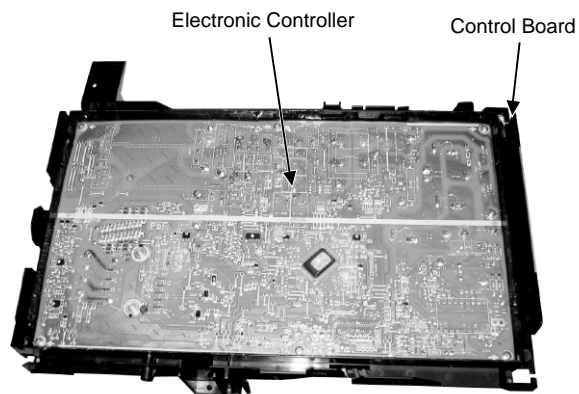

Fig. 6

19.2.2 CU-Z35UBEA

⚠ Caution! When handling electronic controller, be careful of electrostatic discharge.

- 1 Remove the 5 screws of the Top Panel.

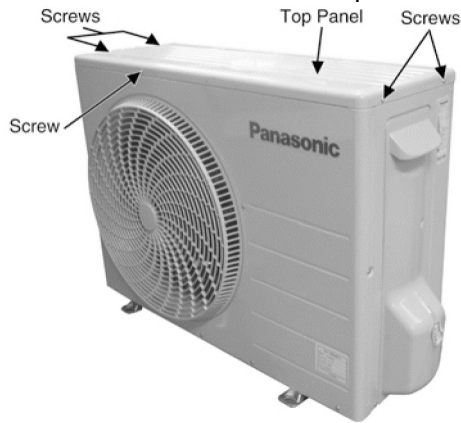

Fig. 1

- 2 Remove the 8 screws of the Front Panel.

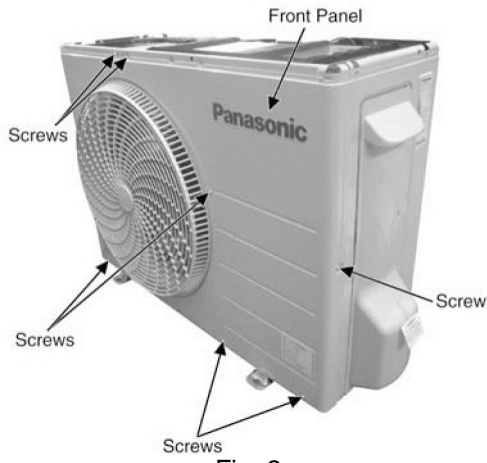

Fig. 2

- 3 Remove the screw of the Terminal Board Cover.
4 Remove the Top Cover of the Control Board by 4 hooks.

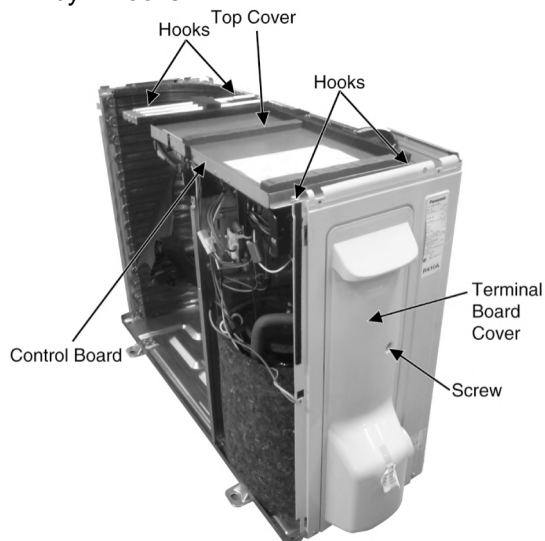

Fig. 3

- 5 Remove the Control Board as follows:

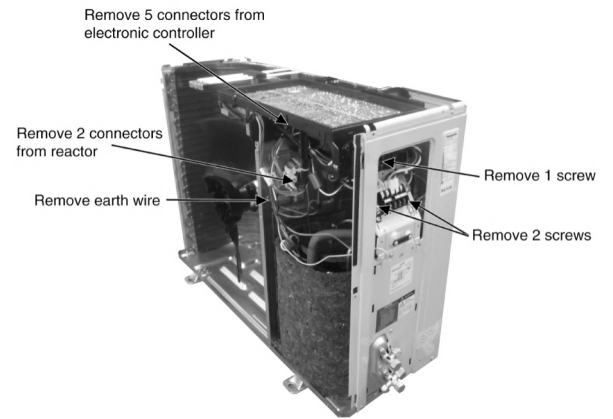

Fig. 4

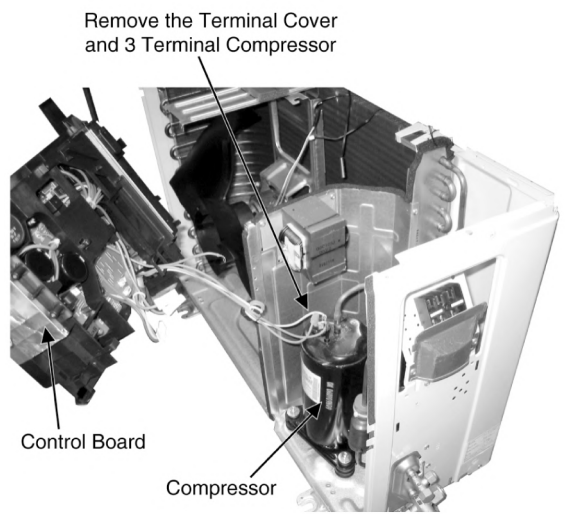

Fig. 5

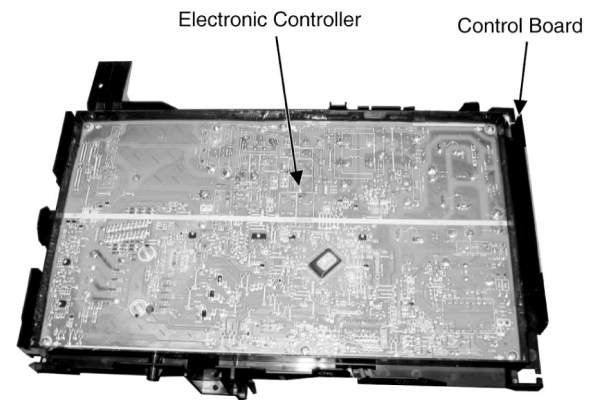



Fig. 6

19.2.3 CU-Z50UBEA CU-Z60UBEA

 Caution! When handling electronic controller, be careful of electrostatic discharge.

- 1 Remove the 5 screws of the Top Panel.

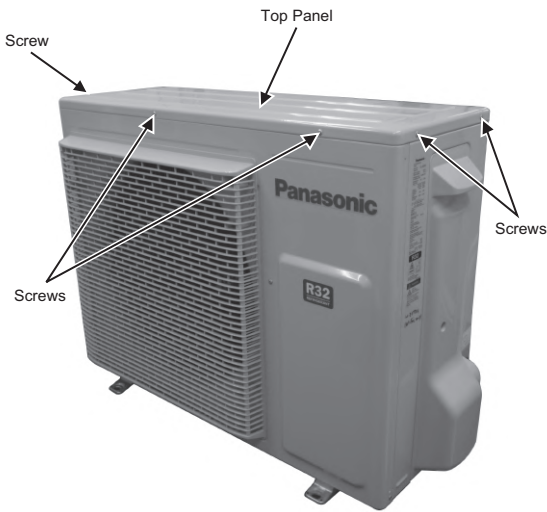

Fig. 1

- 5 Remove 2 screws for the plate of Terminal Board Cover.

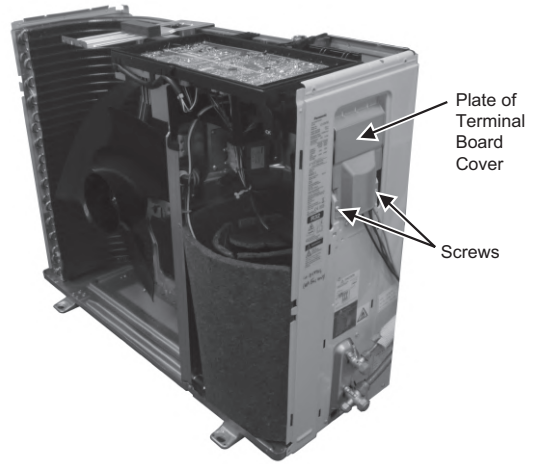

Fig. 4

- 2 Remove the 8 screws of the Front Panel.

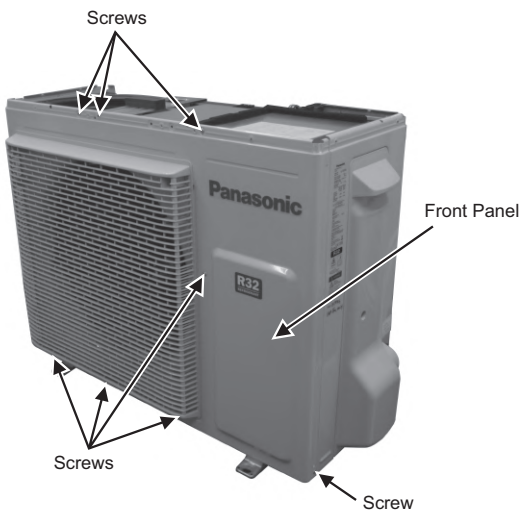

Fig. 2

- 6 Remove the Control Board.

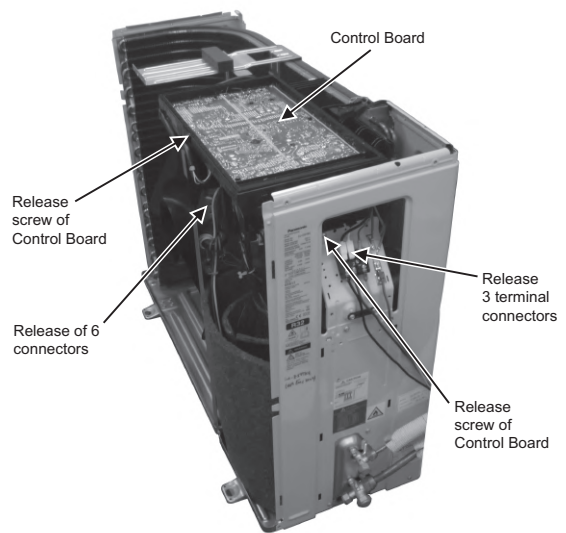

Fig. 5

- 3 Remove the screw of the Terminal Board Cover.
- 4 Remove the Top Cover of the Electronic Controller by 4 hooks.

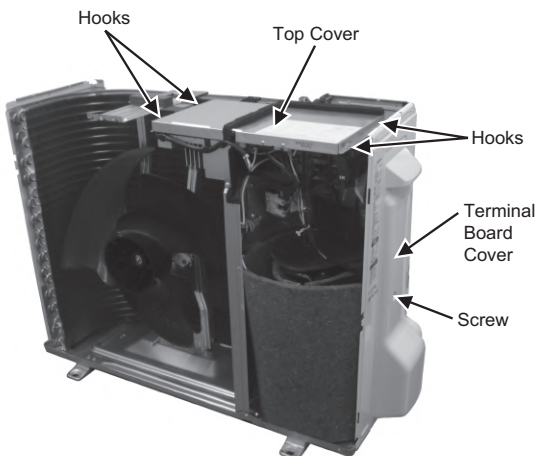

Fig. 3

7. Remove the 4 screws of the Electronic Controller.

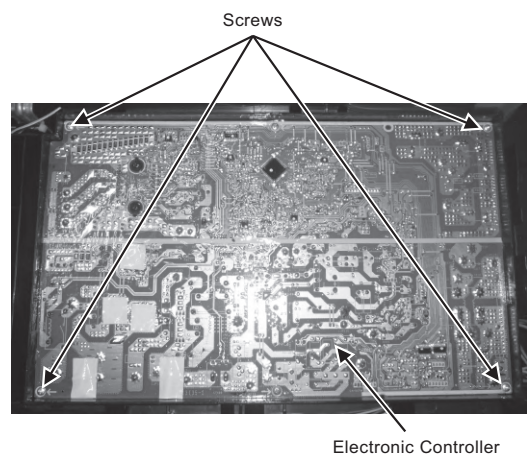

Fig. 6

20. Technical Data

Technical data provided are based on the air conditioner running under free frequency.

20.1 Cool Mode Performance Data

Unit setting: Standard piping length, Hi Fan, Cool mode at 16°C Voltage: 230V

20.1.1 CS-Z25UB4EAW CU-Z25UBEA

Indoor (°C)		Outdoor DB (°C)																				
DB	WB	-10			-7			0			5			16			25			35		
		TC	SHC	IP	TC	SHC	IP	TC	SHC	IP	TC	SHC	IP	TC	SHC	IP	TC	SHC	IP	TC	SHC	IP
27	19.0	3208	2206	435	3003	2800	396	2973	2785	399	3008	2904	383	3331	3085	333	2929	2754	436	2500	2462	550
	22.0	3252	2227	387	3217	2173	425	3254	2213	416	3310	2246	390	3674	2483	324	3208	2206	435	2897	2046	560
23	15.7	2696	2642	409	2579	2528	445	2654	2601	420	2562	2511	460	2504	2319	333	2412	2268	438	2405	2369	552
	18.4	2470	2024	264	2892	2223	435	2919	2255	429	3005	2300	397	2838	2217	248	2543	1991	344	2526	1970	558
20	13.3	2073	2031	210	2080	2039	268	1956	1916	306	2089	2047	270	2166	2123	233	1768	1367	431	1741	1715	523
	15.8	2546	2124	463	2572	1977	486	2669	2184	426	2563	2117	457	2735	2219	283	2163	1505	402	2085	1473	524

(Dry bulb value based on 46% humidity)

20.1.2 CS-Z35UB4EAW CU-Z35UBEA

Indoor (°C)		Outdoor DB (°C)																				
DB	WB	-10			-7			0			5			16			25			35		
		TC	SHC	IP	TC	SHC	IP	TC	SHC	IP	TC	SHC	IP	TC	SHC	IP	TC	SHC	IP	TC	SHC	IP
27	19.0	4336	2540	698	4060	3225	635	4018	3207	640	4066	3344	615	4504	3552	534	3959	3172	700	3500	2937	900
	22.0	4396	2565	621	4350	2502	682	4399	2548	668	4475	2587	626	4966	2859	520	4336	2540	698	3916	2356	899
23	15.7	3645	3205	656	3487	3094	713	3588	3164	674	3463	3100	737	3385	2670	534	3260	2612	702	3251	2728	886
	18.4	3339	2330	423	3909	2560	698	3946	2597	689	4062	2648	637	3837	2553	398	3438	2292	552	3415	2269	896
20	13.3	2802	2731	336	2812	2779	430	2644	2591	491	2824	2790	433	2928	2796	374	2391	1574	691	2354	1975	838
	15.8	3442	2446	742	3476	2276	780	3608	2515	684	3465	2438	733	3697	2555	455	2924	1733	644	2819	1696	840

(Dry bulb value based on 46% humidity)

20.1.3 CS-Z50UB4EAW CU-Z50UBEA

Indoor (°C)		Outdoor DB (°C)																				
DB	WB	-10			-7			0			5			16			25			35		
		TC	SHC	IP	TC	SHC	IP	TC	SHC	IP	TC	SHC	IP	TC	SHC	IP	TC	SHC	IP	TC	SHC	IP
27	19.0	6257	3191	1194	5858	4052	1087	5798	4030	1096	5867	4202	1053	6498	4463	914	5713	3985	1198	5000	3690	1540
	22.0	6343	3222	1063	6276	3143	1167	6347	3202	1142	6456	3250	1072	7166	3592	890	6257	3191	1194	5650	2961	1538
23	15.7	5259	4027	1122	5031	3888	1220	5177	3976	1153	4997	3895	1262	4884	3355	914	4704	3281	1201	4691	3427	1516
	18.4	4818	2928	724	5640	3216	1194	5694	3262	1179	5861	3327	1091	5536	3208	681	4960	2880	944	4928	2851	1533
20	13.3	4043	3431	576	4057	3491	736	3814	3386	840	4075	3505	741	4225	3513	640	3449	1978	1182	3396	2481	1435
	15.8	4966	3074	1270	5016	2860	1334	5206	3160	1170	5000	3063	1255	5335	3210	778	4218	2178	1103	4067	2131	1438

(Dry bulb value based on 46% humidity)

20.1.4 CS-Z60UB4EAW CU-Z60UBEA

Indoor (°C)		Outdoor DB (°C)																				
DB	WB	-10			-7			0			5			16			25			35		
		TC	SHC	IP	TC	SHC	IP	TC	SHC	IP	TC	SHC	IP	TC	SHC	IP	TC	SHC	IP	TC	SHC	IP
27	19.0	7434	3597	1590	6960	4567	1447	6889	4543	1459	6971	4737	1401	7720	5032	1217	6788	4492	1594	6000	4159	2050
	22.0	7537	3632	1415	7457	3543	1553	7541	3610	1521	7671	3664	1426	8514	4049	1185	7434	3597	1590	6713	3337	2048
23	15.7	6248	4540	1493	5977	4383	1624	6151	4482	1535	5937	4391	1680	5803	3782	1217	5589	3699	1599	5574	3864	2018
	18.4	5725	3301	964	6701	3625	1590	6765	3678	1569	6963	3751	1452	6577	3617	907	5893	3247	1256	5855	3214	2041
20	13.3	4803	3868	766	4821	3936	980	4532	3817	1118	4842	3952	987	5019	3960	851	4098	2230	1574	4035	2797	1910
	15.8	5901	3465	1691	5960	3224	1776	6185	3563	1558	5941	3453	1670	6338	3618	1035	5012	2455	1468	4832	2402	1914

(Dry bulb value based on 46% humidity)

TC - Total Cooling Capacity (W)

SHC - Sensible Heat Capacity (W)

IP - Input Power (W)

20.2 Heat Mode Performance Data

Unit setting: Standard piping length, Hi Fan, Heat mode at 30°C Voltage: 230V

20.2.1 CS-Z25UB4EAW CU-Z25UBEA

Indoor (°C)	Outdoor WB (°C)									
	-15		-7		2		7		12	
	TC	IP	TC	IP	TC	IP	TC	IP	TC	IP
24	2191	1099	2848	1203	3330	1188	2986	787	3232	787
20	2335	1092	2880	1190	3480	1170	3200	790	3522	791
16	2491	1081	2591	1052	3499	1144	3443	792	3761	789

20.2.2 CS-Z35UB4EAW CU-Z35UBEA

Indoor (°C)	Outdoor WB (°C)									
	-15		-7		2		7		12	
	TC	IP	TC	IP	TC	IP	TC	IP	TC	IP
24	2280	1309	3333	1617	3885	1574	4257	1319	4609	1319
20	2430	1300	3370	1600	4060	1550	4500	1360	5023	1326
16	2592	1287	3032	1414	4083	1516	4910	1327	5364	1323

20.2.3 CS-Z50UB4EAW CU-Z50UBEA

Indoor (°C)	Outdoor WB (°C)									
	-15		-7		2		7		12	
	TC	IP	TC	IP	TC	IP	TC	IP	TC	IP
24	3279	1842	4351	2274	4919	2163	5207	1844	5638	1842
20	3494	1830	4400	2250	5140	2130	5600	1850	6143	1853
16	3727	1812	3959	1989	5169	2083	6005	1854	6560	1849

20.2.4 CS-Z60UB4EAW CU-Z60UBEA

Indoor (°C)	Outdoor WB (°C)									
	-15		-7		2		7		12	
	TC	IP	TC	IP	TC	IP	TC	IP	TC	IP
24	3816	2057	5043	2476	5550	2467	6531	2392	7071	2390
20	4067	2043	5100	2450	5800	2430	7000	2400	7705	2403
16	4338	2023	4589	2166	5832	2377	7532	2405	8228	2398

TC - Total Heating Capacity (W)

IP - Input Power (W)

21. Service Data

Service data provided are based on the air conditioner running under rated frequency during forced cooling / forced heating mode.

21.1 Cool Mode Outdoor Air Temperature Characteristic

Condition

- Indoor room temperature: 27°C Dry Bulb/19°C Wet Bulb
- Unit setting: Standard piping length, forced cooling at 16°C, Hi fan
- Compressor frequency: Rated for cooling operation
- Piping length: 5m
- Voltage: 230V

21.1.1 CS-Z25UB4EAW CU-Z25UBEA

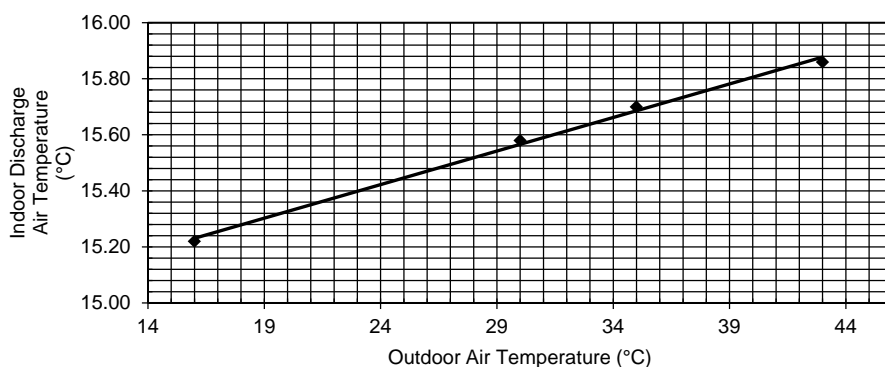
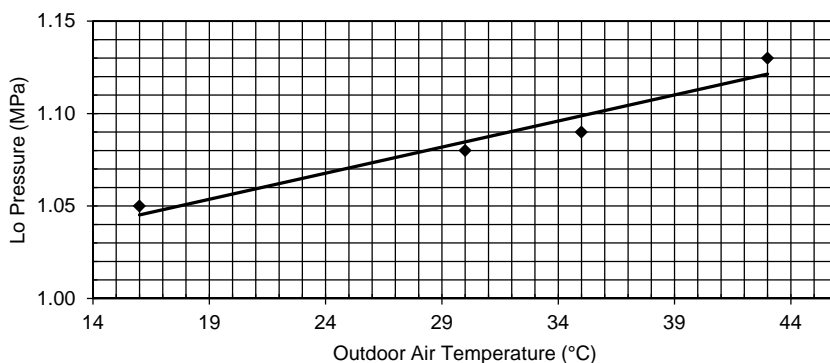
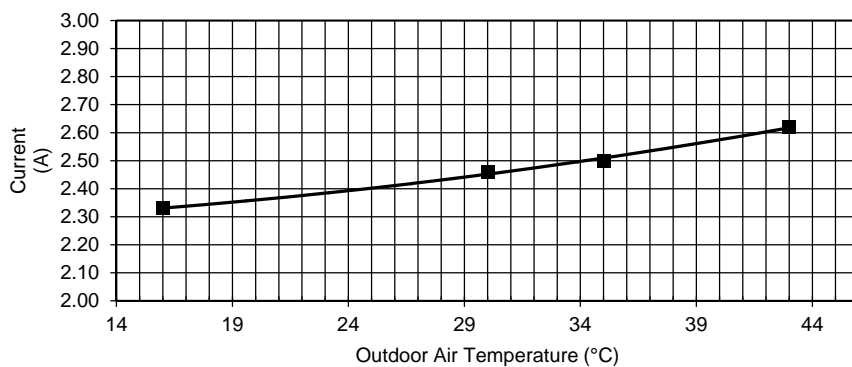

21.1.2 CS-Z35UB4EAW CU-Z35UBEA

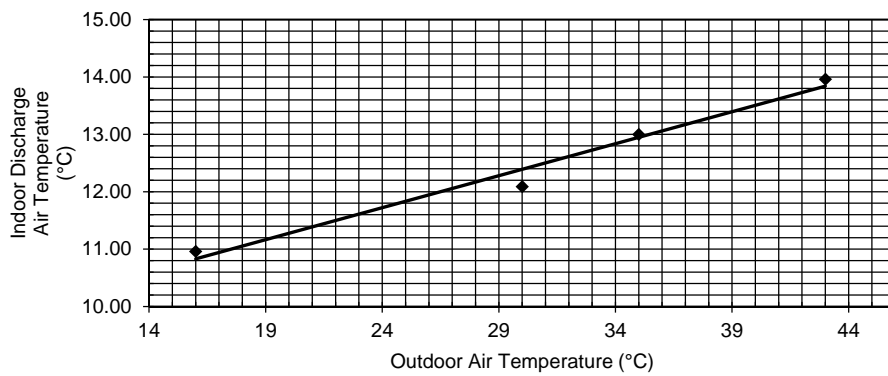
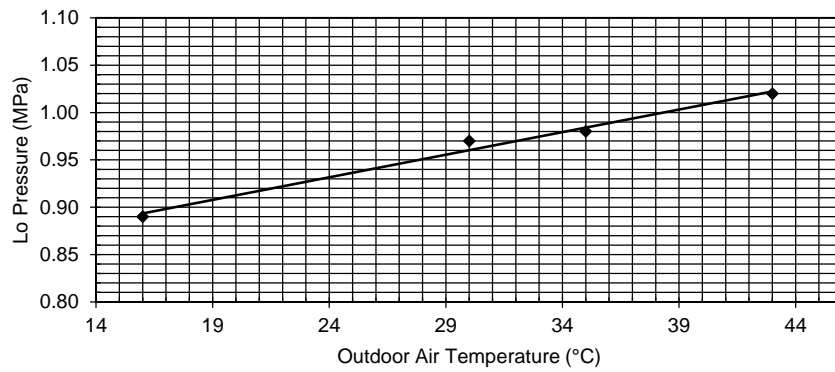
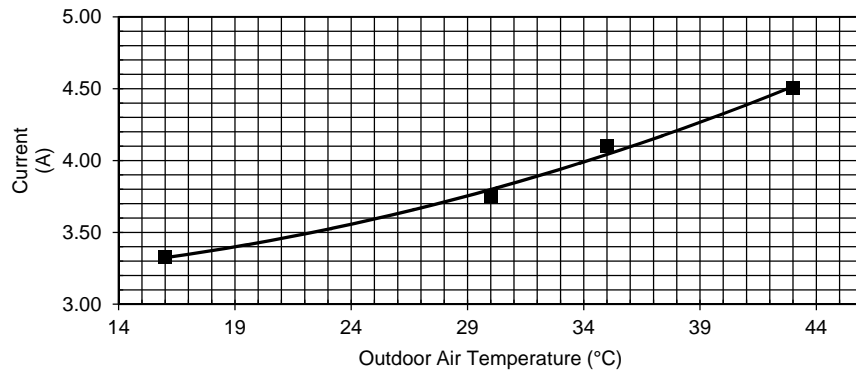

21.1.3 CS-Z50UB4EAW CU-Z50UBEA

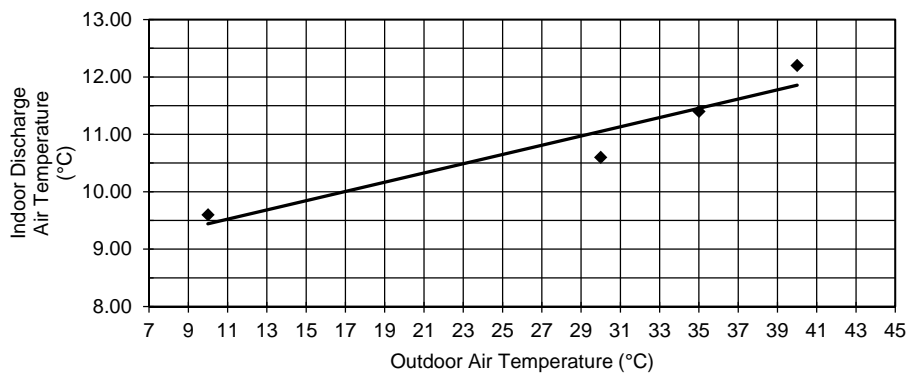
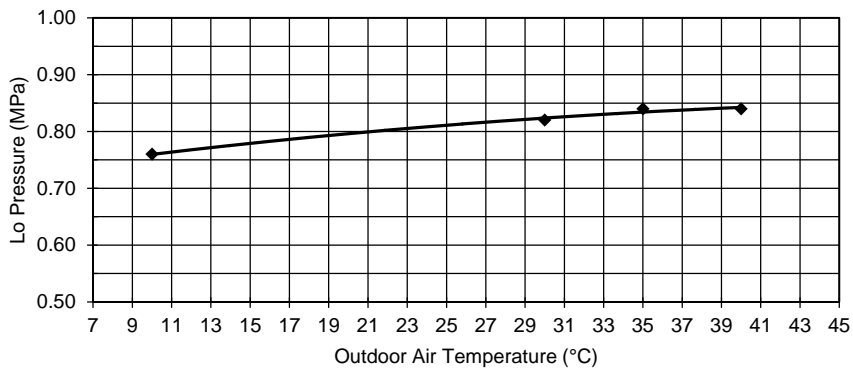
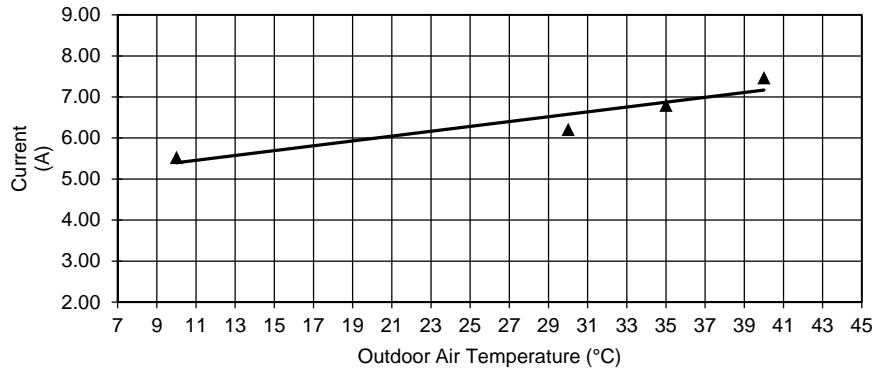

21.1.4 CS-Z60UB4EAW CU-Z60UBEA

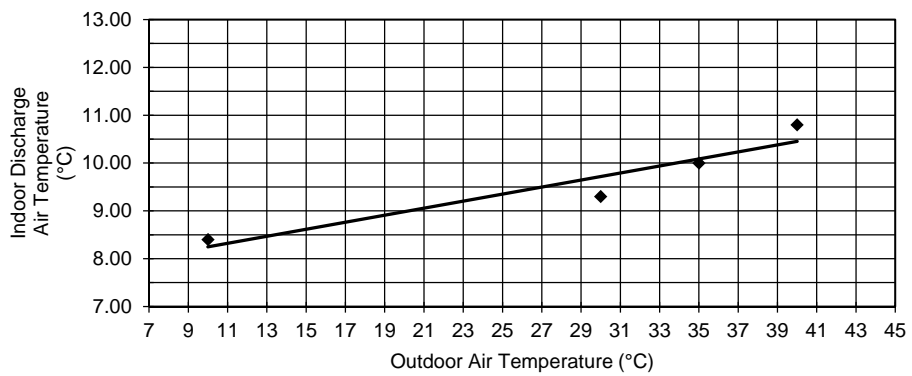
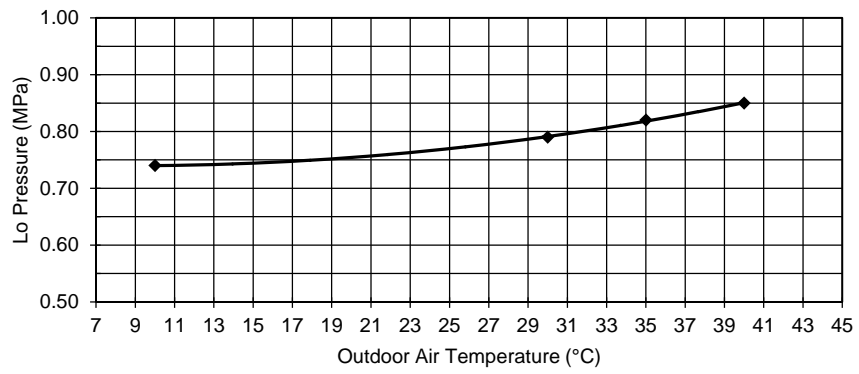
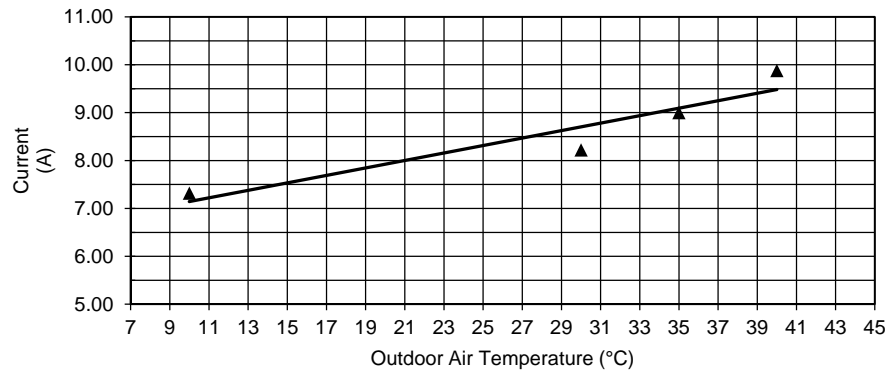

21.2 Heat Mode Outdoor Air Temperature Characteristic

Condition

- Indoor room temperature: 20°C Dry Bulb/ -°C Wet Bulb
- Unit setting: Standard piping length, forced heating at 30°C, Hi fan
- Compressor frequency: Rated for Heating operation
- Piping length: 5m
- Voltage: 230V

21.2.1 CS-Z25UB4EAW CU-Z25UBEA

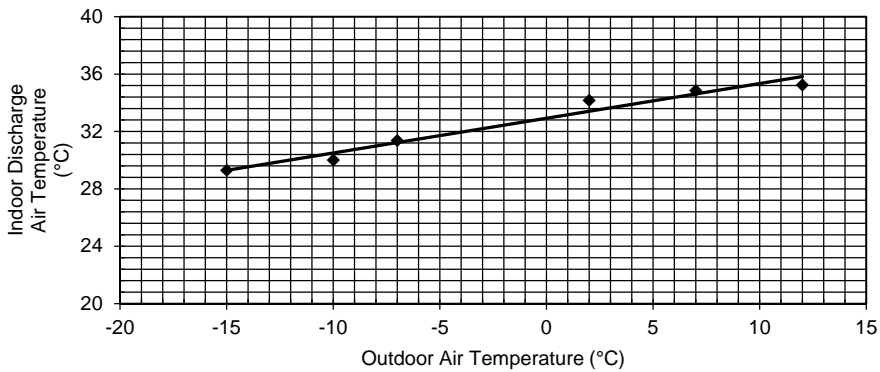
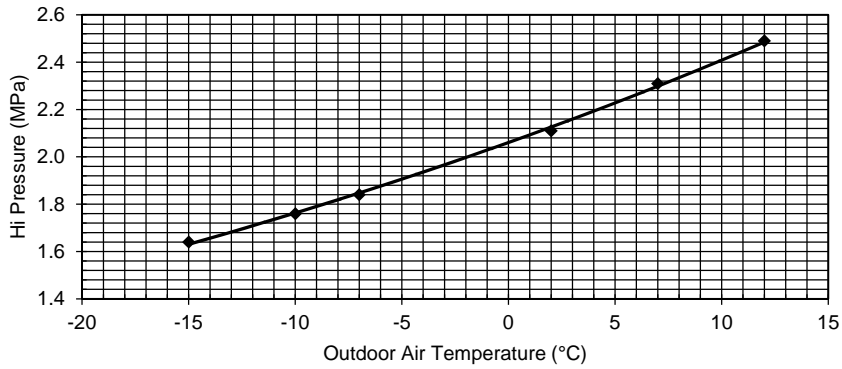
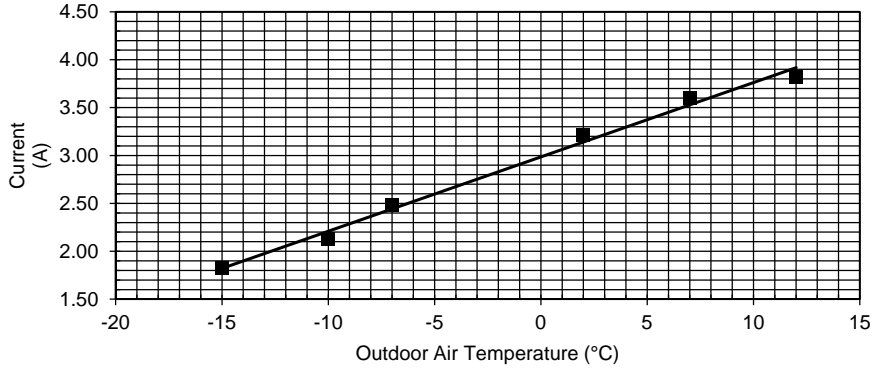

21.2.2 CS-Z35UB4EAW CU-Z35UBEA

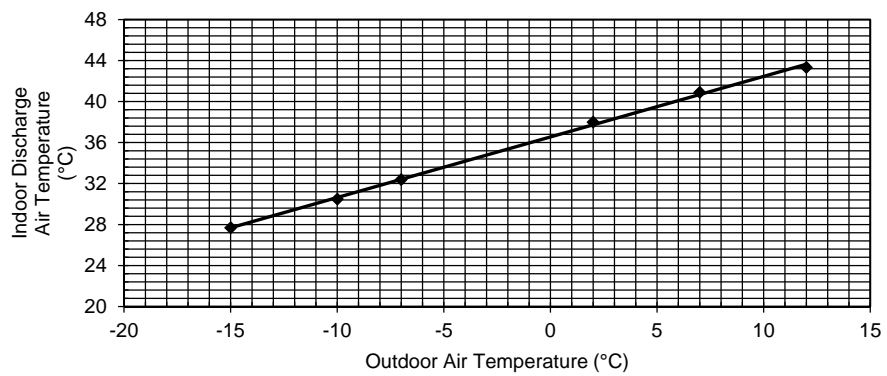
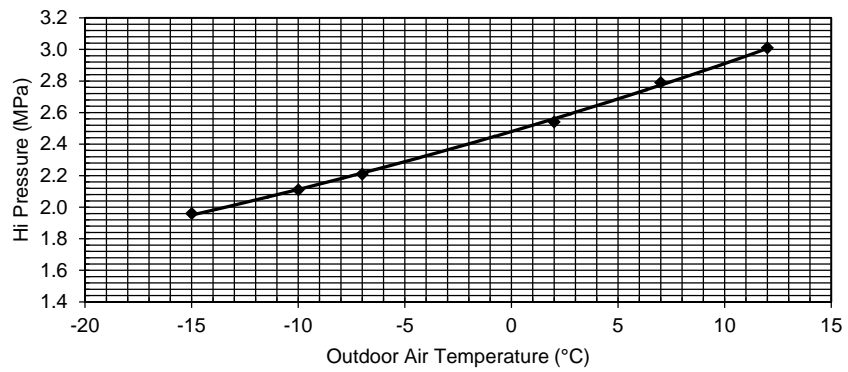
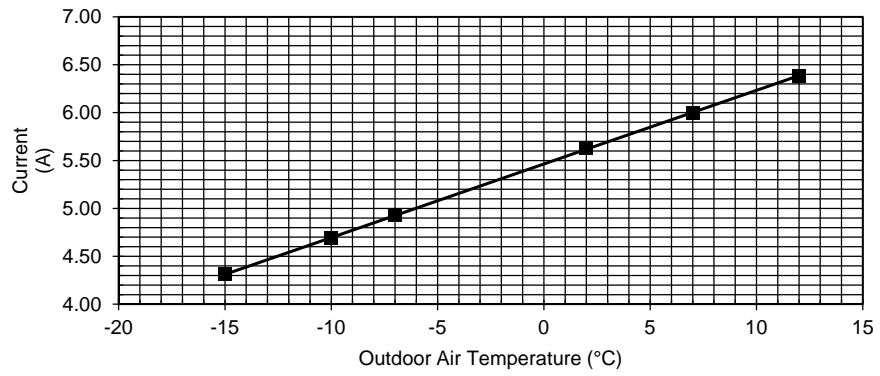

21.2.3 CS-Z50UB4EAW CU-Z50UBEA

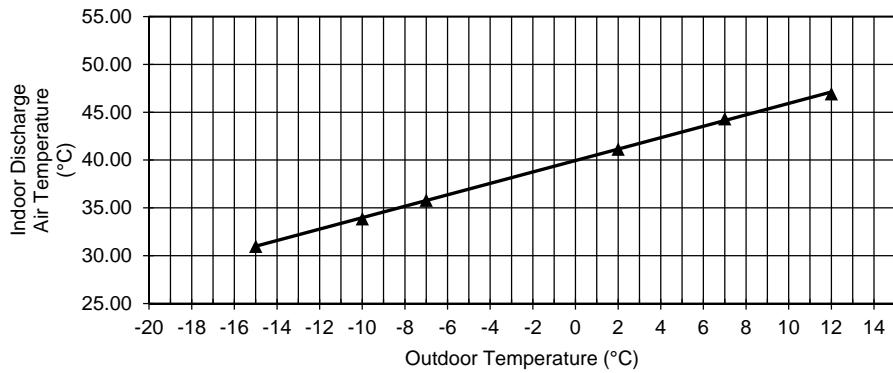
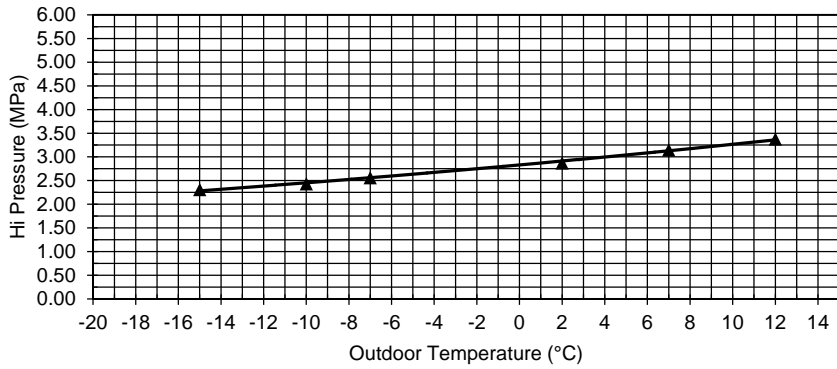
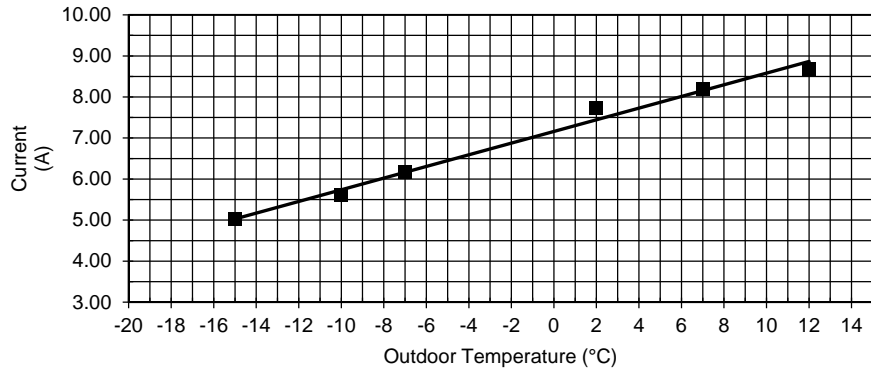

21.2.4 CS-Z60UB4EAW CU-Z60UBEA

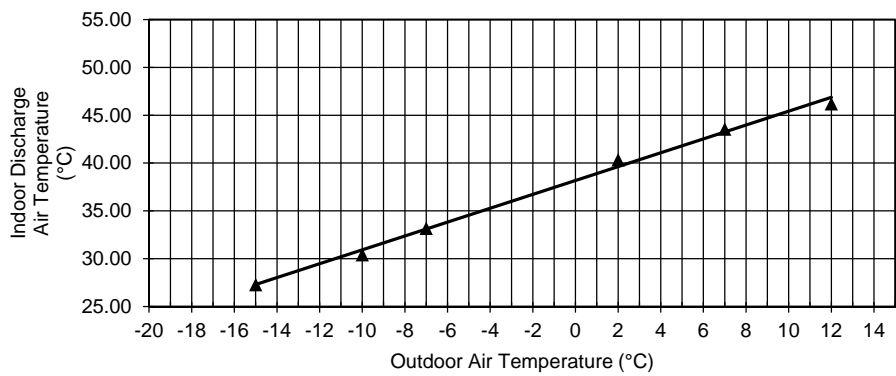
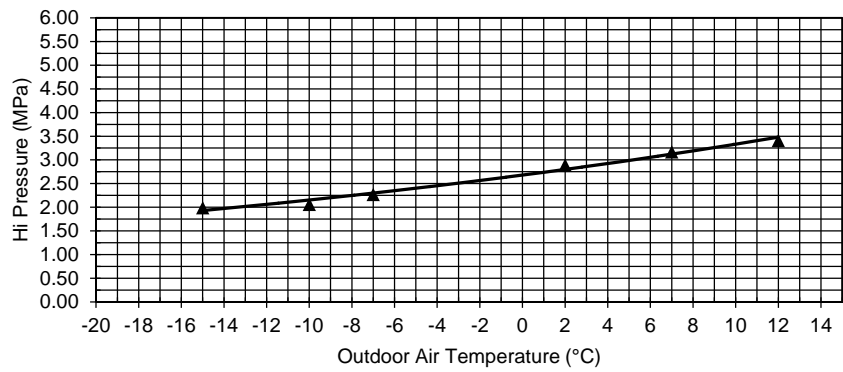
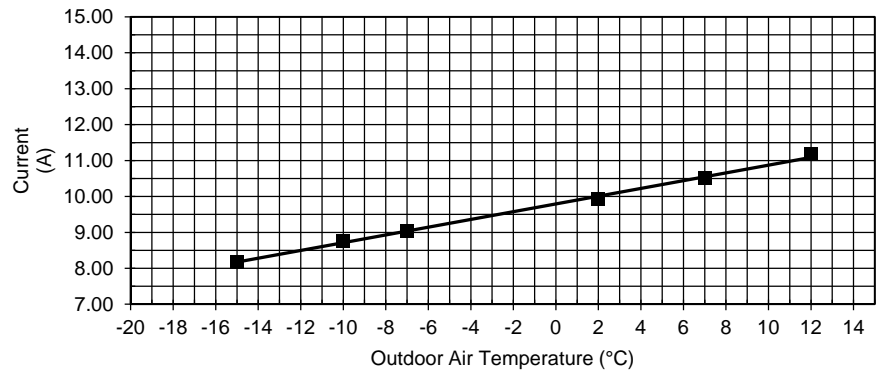

21.3 Piping Length Correction Factor

The characteristic of the unit has to be corrected in accordance with the piping length.

21.3.1 CS-Z25UB4EAW CU-Z25UBEA

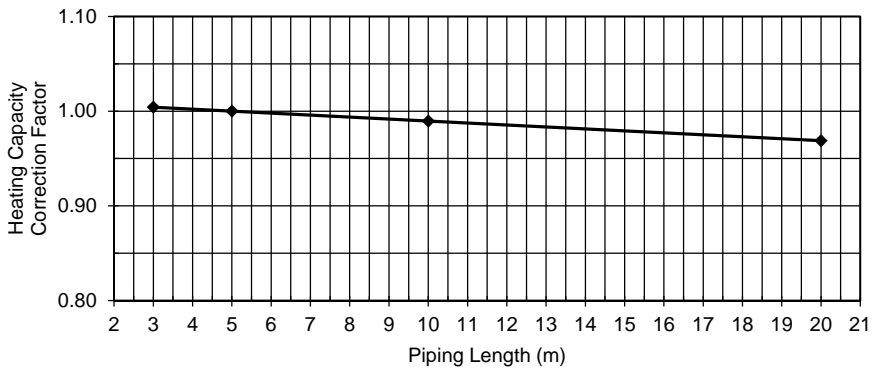
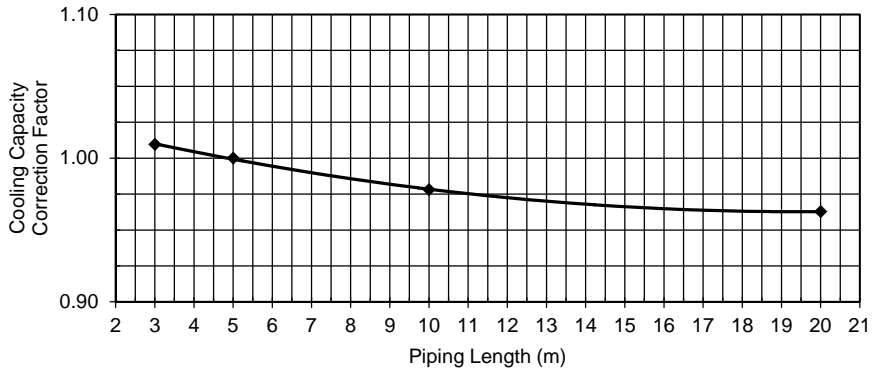

21.3.2 CS-Z35UB4EAW CU-Z35UBEA

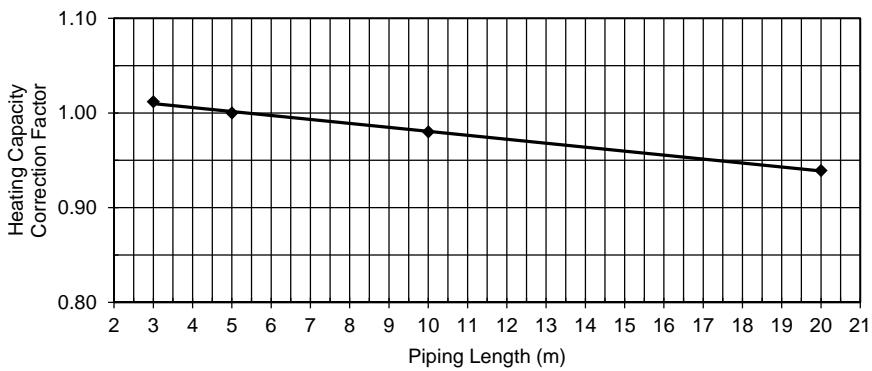
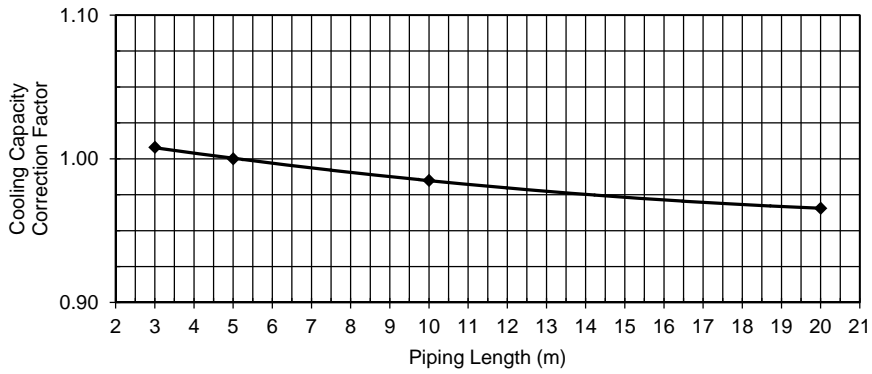

21.3.3 CS-Z50UB4EAW CU-Z50UBEA CS-Z60UB4EAW CU-Z60UBEA

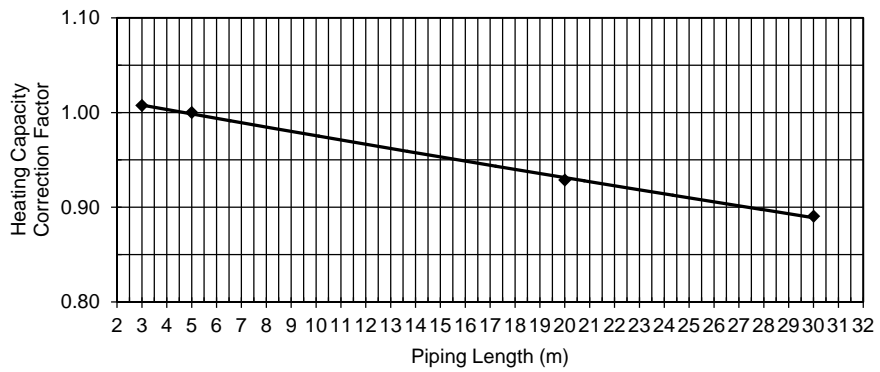
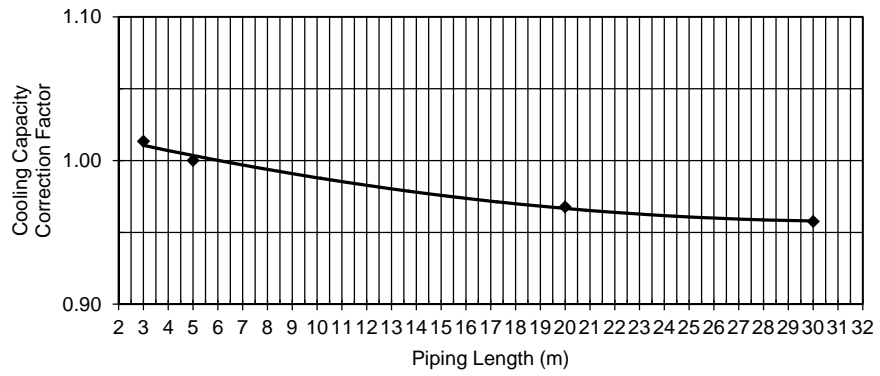

Note: The graphs show the factor after added right amount of additional refrigerant.

22. Exploded View and Replacement Parts List

22.1 Indoor Unit

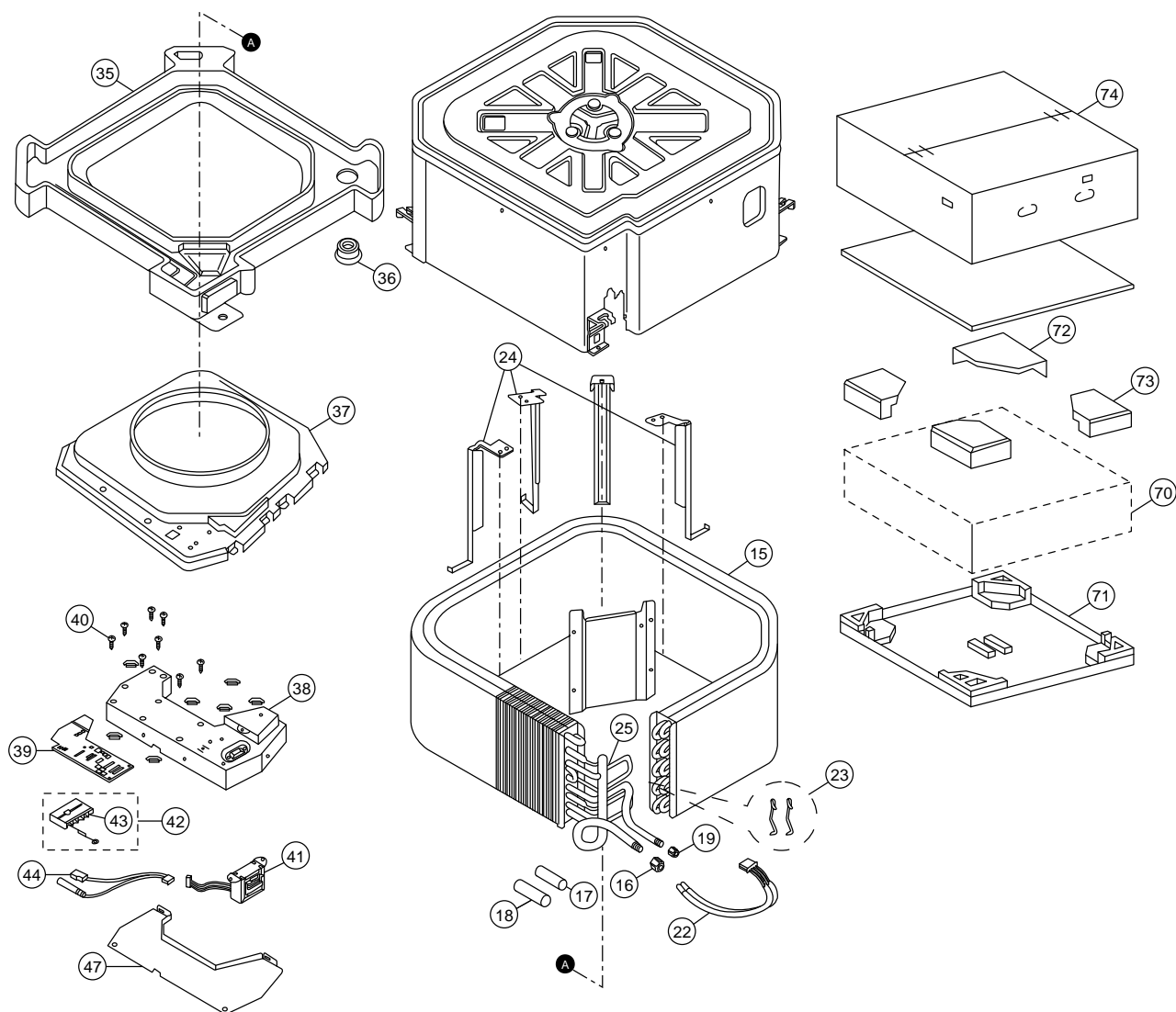

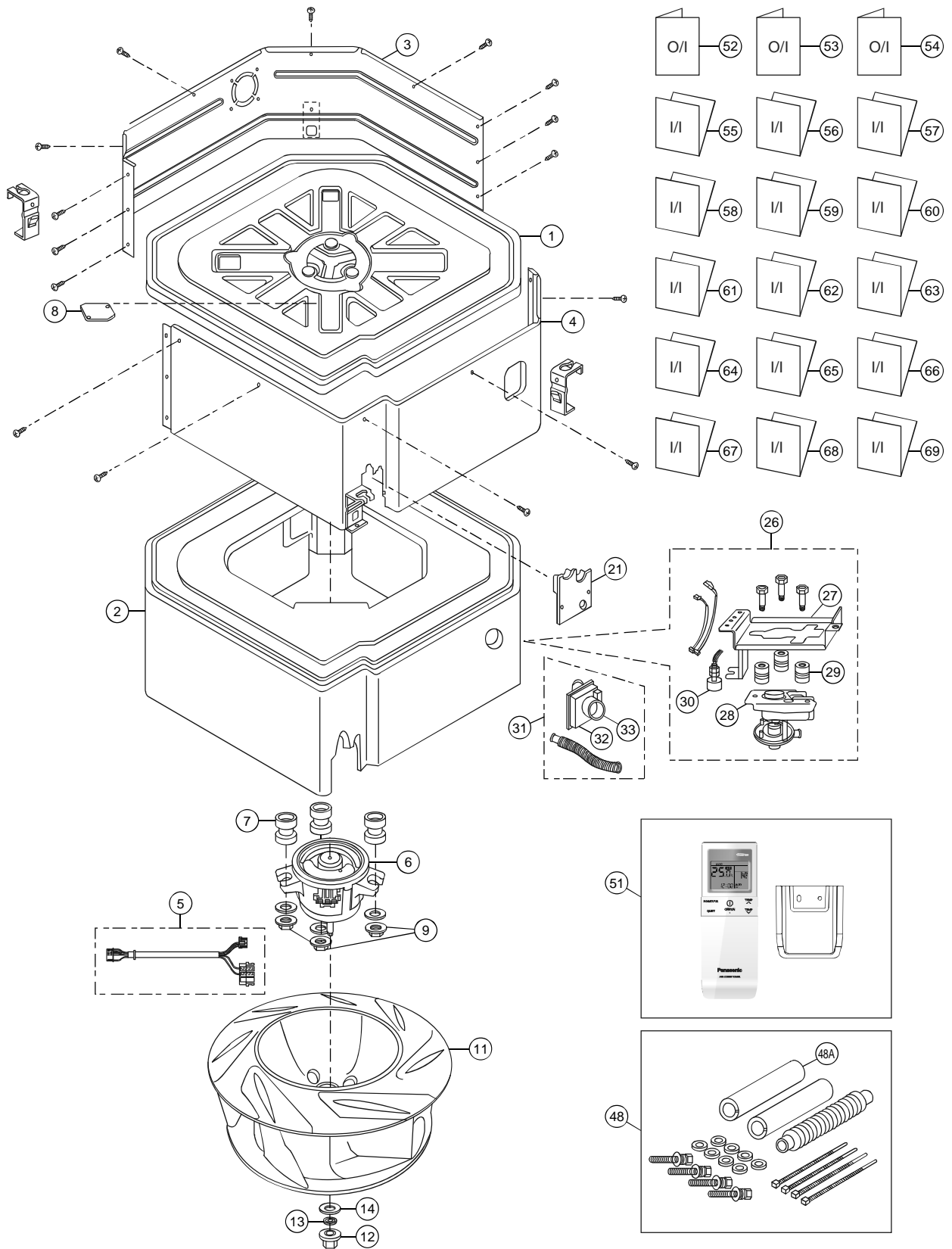

Note:

The above exploded view is for the purpose of parts disassembly and replacement.
 The non-numbered parts are not kept as standard service parts.

SAFETY	REF. NO.	PART NAME & DESCRIPTION	QTY	CS-Z25UB4EAW	CS-Z35UB4EAW	REMARK
	1	BASE PAN ASS'Y	1	CWD52K1100	←	
	2	INNER POLYSTYRENE COMPLETE	1	CWG07C1047	←	
	3	CABINET SIDE PLATE ASS'Y	1	CWE041121	←	
	4	CABINET SIDE PLATE ASS'Y	1	CWE041122	←	
	5	LEAD WIRE - FAN MOTOR	1	CWA67C5136	←	O
⚠	6	FAN MOTOR	1	EHDS50A40AC	←	O
	7	ANTI - VIBRATION BUSHING	3	CWH501065	←	
	8	CORD HOLDER	1	CWD741024	←	
	9	SCREW - FAN MOTOR	3	CWH561058	←	
	11	TURBO FAN	1	CWH03K1022	←	
	12	NUT for TURBO FAN	1	CWH561042	←	
	13	SP WASHER	1	XWA8BFJ	←	
	14	WASHER	1	XWG8H22FJ	←	
	15	EVAPORATOR COMPLETE	1	ACXB30C10390	←	
	16	FLARE NUT (3/8")	1	CWT251031	←	
	17	HEATPROOF TUBE	1	ACXG02-00740	←	
	18	HEATPROOF TUBE	1	CWG021059	←	
	19	FLARE NUT (1/4")	1	CWT251030	←	
	21	PIPE COVER	1	CWD93C1050	←	
	22	SENSOR - EVAPORATOR	1	CWA50C2549	←	
	23	HOLDER SENSOR	2	CWH32143	←	
	24	EVAPORATOR SUPPORTER	3	CWD911529A	←	
	25	TUBE ASS'Y (CAPIL. TUBE)	1	ACXT07K04180	←	
	26	DRAIN PUMP COMPLETE	1	CWB53C1015	←	O
	27	PANEL DRAIN PUMP ASS'Y	1	CWD93K1021	←	
⚠	28	DRAIN PUMP	1	CWB532059	←	
	29	ANTI - VIBRATION BUSHING	3	CWH501080	←	
	30	FLOAT SWITCH - DRAIN PUMP	1	CWA121233	←	O
	31	FLEXIBLE PIPE	1	CWH85C1033	←	
	32	DRAIN NOZZLE	1	CWH411011	←	
	33	DRAIN HOSE HEAT INSULATION	1	CWG321050	←	
	35	DRAIN PAN - COMPLETE	1	CWH40C1034	←	
	36	DRAIN PLUG	1	CWB821008	←	
	37	AIR GUIDER BLOWER WHEEL	1	CWD321058	←	
	38	CONTROL BOARD CASING	1	CWH10K1102	←	
⚠	39	ELECTRONIC CONTROLLER (MAIN)	1	ACXA73C40560	ACXA73C40570	O
	40	SPACER	6	CWH541026	←	
⚠	41	TRANSFORMER	1	CWA40C1030	←	O
⚠	42	TERMINAL BOARD ASS'Y	1	CWA28K1321	←	O
⚠	43	TERMINAL BOARD ASS'Y	1	CWA28K1191	←	O
	44	LEADWIRE-AIR TEMP. SENSOR	1	CWA68C1507	←	O
	47	CONTROL BOARD COVER COM.	1	ACXH13C01310	←	
	48	ACCESSORY COMPLETE	1	CWH82C1270	←	
	48A	HEATPROOF TUBE	1	CWG021025	←	
	51	WIRELESS REMOTE CONTROL COMPLETE	1	ACXA75C13400	←	O
	52	OPERATING INSTRUCTION	1	ACXF55-17710	←	
	53	OPERATING INSTRUCTION	1	ACXF55-17720	←	

SAFETY	REF. NO.	PART NAME & DESCRIPTION	QTY	CS-Z25UB4EAW	CS-Z35UB4EAW	REMARK
	54	OPERATING INSTRUCTION	1	ACXF55-17910	←	
	55	INSTALLATION INSTRUCTION	1	ACXF60-26380	←	
	56	INSTALLATION INSTRUCTION	1	ACXF60-26390	←	
	57	INSTALLATION INSTRUCTION	1	ACXF60-26400	←	
	58	INSTALLATION INSTRUCTION	1	ACXF60-26410	←	
	59	INSTALLATION INSTRUCTION	1	ACXF60-26420	←	
	60	INSTALLATION INSTRUCTION	1	ACXF60-26430	←	
	61	INSTALLATION INSTRUCTION	1	ACXF60-26440	←	
	62	INSTALLATION INSTRUCTION	1	ACXF60-26450	←	
	63	INSTALLATION INSTRUCTION	1	ACXF60-26460	←	
	64	INSTALLATION INSTRUCTION	1	ACXF60-26470	←	
	65	INSTALLATION INSTRUCTION	1	ACXF60-26480	←	
	66	INSTALLATION INSTRUCTION	1	ACXF60-26490	←	
	67	INSTALLATION INSTRUCTION	1	ACXF60-26500	←	
	68	INSTALLATION INSTRUCTION	1	ACXF60-26620	←	
	69	INSTALLATION INSTRUCTION	1	ACXF60-26630	←	
	70	BAG	1	CWG86420	←	
	71	BASE BOARD-COMPLETE	1	ACXG62C00900	←	
	72	SHOCK ABSORBER	1	ACXG70-06390	←	
	73	SHOCK ABSORBER	2	CWG712510	←	
	74	C.C. CASE	1	ACXG50-30100	←	

(Note)

- All parts are supplied from PAPAMY, Malaysia (Vendor Code: 00029488).
- "O" marked parts are recommended to be kept in stock.

SAFETY	REF. NO.	PART NAME & DESCRIPTION	QTY	CS-Z50UB4EAW	CS-Z60UB4EAW	REMARK
	1	BASE PAN ASS'Y	1	CWD52K1100	←	
	2	INNER POLYSTYRENE COMPLETE	1	CWG07C1047	←	
	3	CABINET SIDE PLATE ASS'Y	1	CWE041121	←	
	4	CABINET SIDE PLATE ASS'Y	1	CWE041122	←	
	5	LEAD WIRE - FAN MOTOR	1	CWA67C5136	←	O
⚠	6	FAN MOTOR	1	EHDS50A40AC	←	O
	7	ANTI - VIBRATION BUSHING	3	CWH501065	←	
	8	CORD HOLDER	1	CWD741024	←	
	9	SCREW - FAN MOTOR	3	CWH561058	←	
	11	TURBO FAN	1	CWH03K1022	←	
	12	NUT for TURBO FAN	1	CWH561042	←	
	13	SP WASHER	1	XWA8BFJ	←	
	14	WASHER	1	XWG8H22FJ	←	
	15	EVAPORATOR COMPLETE	1	ACXB30C10410	CWB30C5038	
	16	FLARE NUT (1/2")	1	CWT251032	←	
	17	HEATPROOF TUBE	1	ACXG02-00740	←	
	18	HEATPROOF TUBE	1	CWG021059	←	
	19	FLARE NUT (1/4")	1	CWT251030	←	
	21	PIPE COVER	1	CWD93C1050	←	
	22	SENSOR - EVAPORATOR	1	CWA50C2549	←	
	23	HOLDER SENSOR	2	CWH32143	←	
	24	EVAPORATOR SUPPORTER	3	CWD911529A	←	
	25	TUBE ASS'Y (CAPIL. TUBE)	1	ACXT07K04180	←	
	26	DRAIN PUMP COMPLETE	1	CWB53C1015	←	O
	27	PANEL DRAIN PUMP ASS'Y	1	CWD93K1021	←	
⚠	28	DRAIN PUMP	1	CWB532059	←	
	29	ANTI - VIBRATION BUSHING	3	CWH501080	←	
	30	FLOAT SWITCH - DRAIN PUMP	1	CWA121233	←	O
	31	FLEXIBLE PIPE	1	CWH85C1033	←	
	32	DRAIN NOZZLE	1	CWH411011	←	
	33	DRAIN HOSE HEAT INSULATION	1	CWG321050	←	
	35	DRAIN PAN - COMPLETE	1	CWH40C1034	←	
	36	DRAIN PLUG	1	CWB821008	←	
	37	AIR GUIDER BLOWER WHEEL	1	CWD321058	←	
	38	CONTROL BOARD CASING	1	CWH10K1102	←	
⚠	39	ELECTRONIC CONTROLLER (MAIN)	1	ACXA73C40580	ACXA73C40590	O
	40	SPACER	6	CWH541026	←	
⚠	41	TRANSFORMER	1	CWA40C1030	←	O
⚠	42	TERMINAL BOARD ASS'Y	1	CWA28K1321	←	O
⚠	43	TERMINAL BOARD ASS'Y	1	CWA28K1191	←	O
	44	LEADWIRE-AIR TEMP. SENSOR	1	CWA68C1507	←	O
	47	CONTROL BOARD COVER COM.	1	ACXH13C01310	←	
	48	ACCESSORY COMPLETE	1	CWH82C1270	←	
	48A	HEATPROOF TUBE	1	CWG021025	←	
	51	WIRELESS REMOTE CONTROL COMPLETE	1	ACXA75C13400	←	O
	52	OPERATING INSTRUCTION	1	ACXF55-17710	←	
	53	OPERATING INSTRUCTION	1	ACXF55-17720	←	

SAFETY	REF. NO.	PART NAME & DESCRIPTION	QTY	CS-Z50UB4EAW	CS-Z60UB4EAW	REMARK
	54	OPERATING INSTRUCTION	1	ACXF55-17910	←	
	55	INSTALLATION INSTRUCTION	1	ACXF60-26380	←	
	56	INSTALLATION INSTRUCTION	1	ACXF60-26390	←	
	57	INSTALLATION INSTRUCTION	1	ACXF60-26400	←	
	58	INSTALLATION INSTRUCTION	1	ACXF60-26410	←	
	59	INSTALLATION INSTRUCTION	1	ACXF60-26420	←	
	60	INSTALLATION INSTRUCTION	1	ACXF60-26430	←	
	61	INSTALLATION INSTRUCTION	1	ACXF60-26440	←	
	62	INSTALLATION INSTRUCTION	1	ACXF60-26450	←	
	63	INSTALLATION INSTRUCTION	1	ACXF60-26460	←	
	64	INSTALLATION INSTRUCTION	1	ACXF60-26470	←	
	65	INSTALLATION INSTRUCTION	1	ACXF60-26480	←	
	66	INSTALLATION INSTRUCTION	1	ACXF60-26490	←	
	67	INSTALLATION INSTRUCTION	1	ACXF60-26500	←	
	68	INSTALLATION INSTRUCTION	1	ACXF60-26620	←	
	69	INSTALLATION INSTRUCTION	1	ACXF60-26630	←	
	70	BAG	1	CWG86420	←	
	71	BASE BOARD-COMPLETE	1	ACXG62C00900	←	
	72	SHOCK ABSORBER	1	ACXG70-06390	←	
	73	SHOCK ABSORBER	2	CWG712510	←	
	74	C.C. CASE	1	ACXG50-30100	←	

(Note)

- All parts are supplied from PAPAMY, Malaysia (Vendor Code: 00029488).
- "O" marked parts are recommended to be kept in stock.

22.2 CZ-BT20EW (Front Grille Complete)

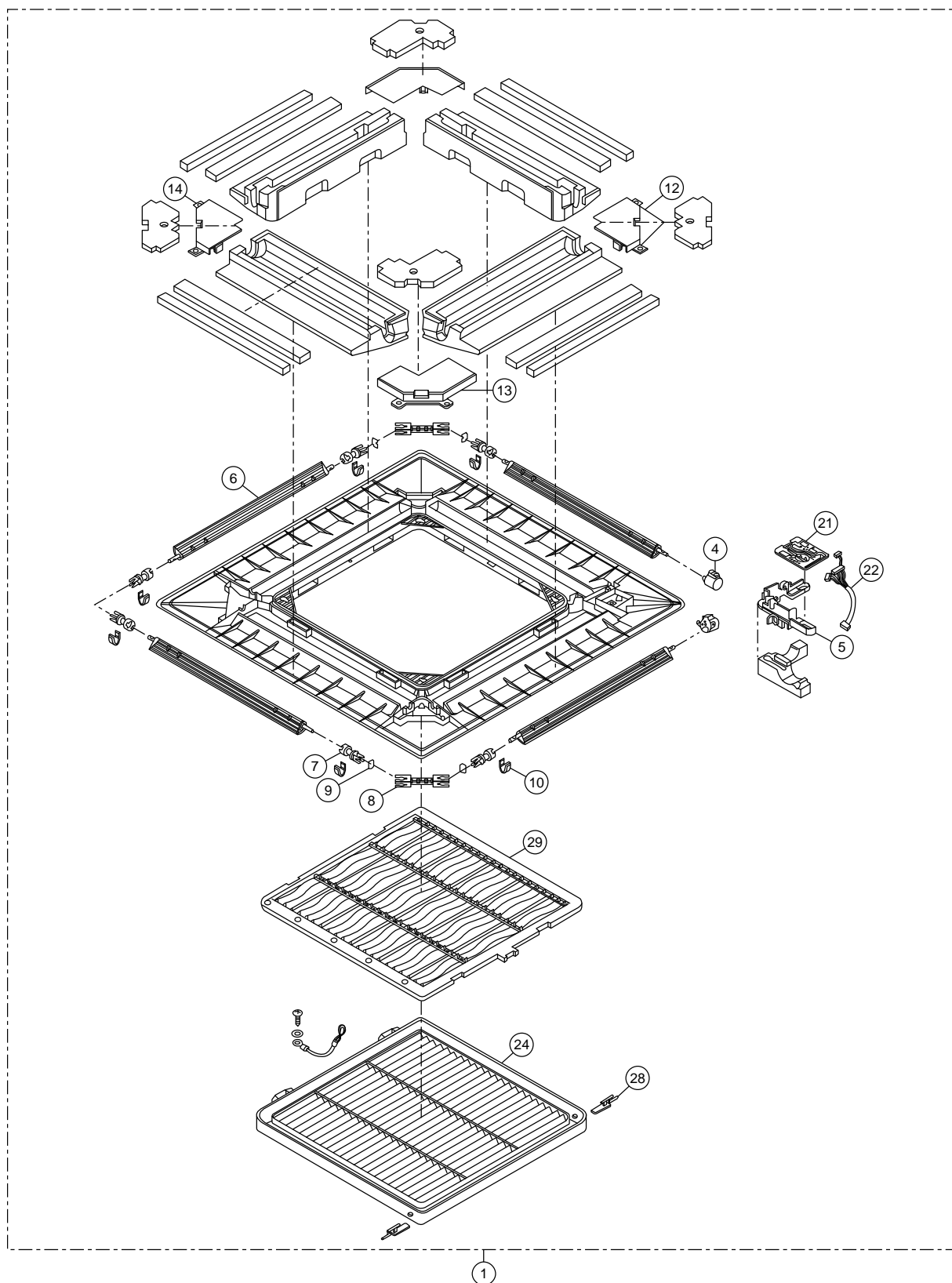

Note:
The above exploded view is for the purpose of parts disassembly and replacement.
The non-numbered parts are not kept as standard service parts.

SAFETY	REF. NO.	PART NAME & DESCRIPTION	QTY	CZ-BT20EW	REMARK
	1	FRONT GRILLE - COMPLETE	1	ACXE10C07740	
⚠	4	A.S MOTOR DC SINGLE 12V 250 OHM	2	CWA981105J	O
	5	BRACKET - A.S.MOTOR	1	CWD932522	
	6	VANE	4	CWE241159A	
	7	SHAFT	6	CWH631038	
	8	SHAFT	2	CWH631045	
	9	CONNECTOR - SHAFT	4	CWH081007	
	10	BEARING	6	CWH641008	O
	12	PLATE COVER FOR A.S.MOTOR	1	CWD911459	
	13	PLATE COVER FOR CONNECTING SHAFT	2	CWD911460	
	14	PLATE COVER FOR END SHAFT	1	CWD911461	
	21	ELECTRONIC CONT. (RECEIVER & INDICATOR)	1	CWA743610	
	22	LEAD WIRE - COMPLETE	1	CWA67C5576	
	24	INTAKE GRILLE	1	CWE221131A	
	28	LEVER ARM	2	CWH651029A	
	29	AIR FILTER	1	CWD001142	O

(Note)

- All parts are supplied from PAPAMY, Malaysia (Vendor Code: 00029488).
- "O" marked parts are recommended to be kept in stock.

22.3 Outdoor Unit

22.3.1 CU-Z25UBEA

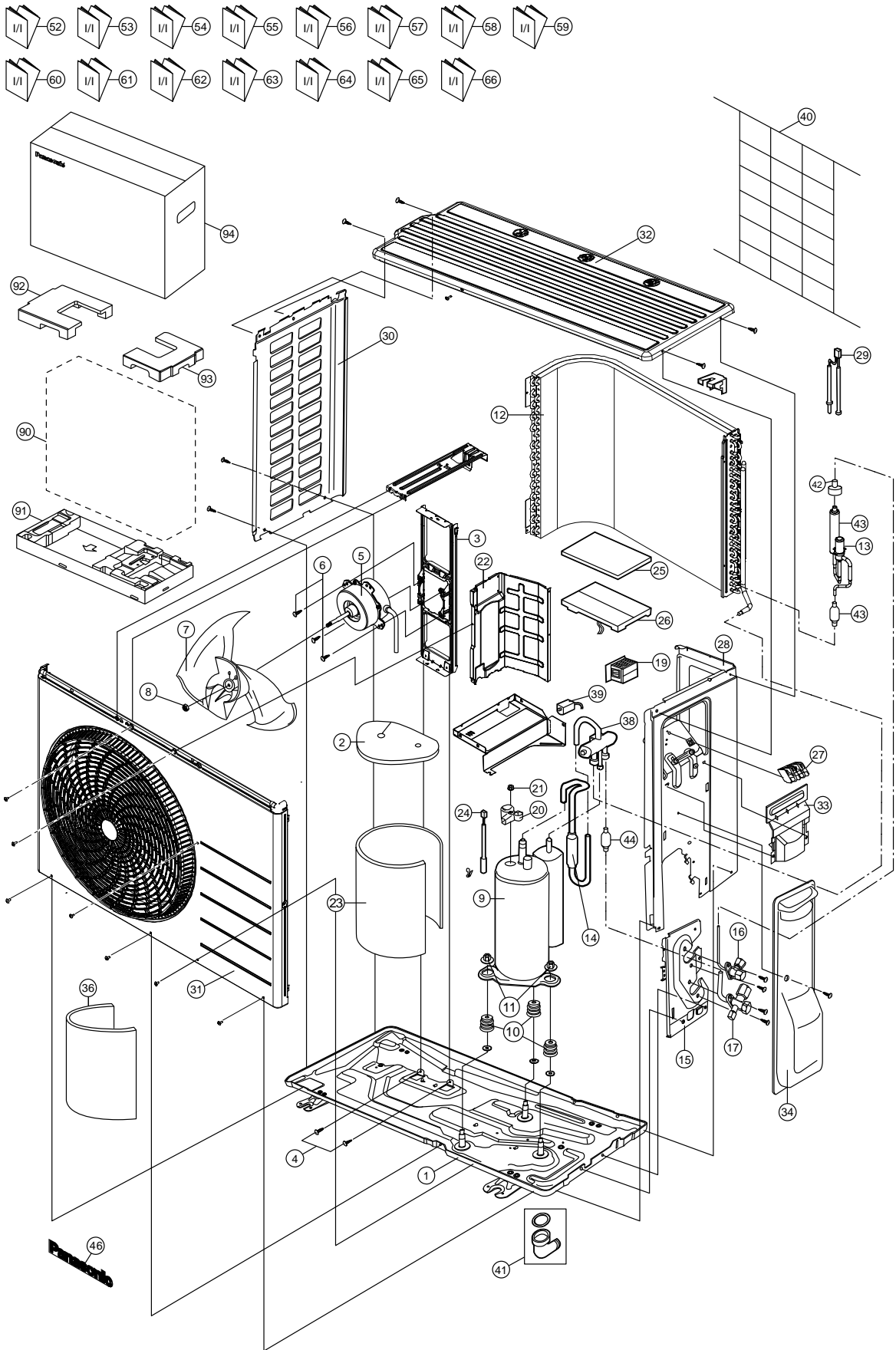

Note
The above exploded view is for the purpose of parts disassembly and replacement.
The non-numbered parts are not kept as standard service parts.

SAFETY	REF. NO.	PART NAME & DESCRIPTION	QTY.	CU-Z25UBEA	REMARK
	1	CHASSIS COMPLETE	1	CWD52K1399	
	2	SOUND PROOF MATERIAL (TOP)	1	CWG302314	
	3	FAN MOTOR BRACKET	1	CWD541157	
	4	SCREW - FAN MOTOR BRACKET	2	CWH551217	
⚠	5	FAN MOTOR	1	L6CAYYYL0064	O
	6	SCREW - FAN MOTOR MOUNT	4	CWH55252J	
	7	PROPELLER FAN ASSY	1	CWH03K1100	
	8	NUT - PROPELLER FAN	1	CWH56053J	
⚠	9	COMPRESSOR	1	9RS102XFA21	O
	10	ANTI - VIBRATION BUSHING	3	CWH50077	
	11	NUT - COMPRESSOR MOUNT	3	CWH561096	
	12	CONDENSER	1	ACXB32C00760	
	13	EXPANSION VALVE	1	CWB051078	
	14	DISCHARGE MUFFLER (4 W.VALVE)	1	CWB121010	
	15	HOLDER COUPLING	1	CWH351233	
	16	2-WAYS VALVE (LIQUID)	1	ACXB02-02650	O
	17	3-WAY VALVE (GAS)	1	CWB011581	O
⚠	19	REACTOR	1	G0C392J00028	O
	20	TERMINAL COVER	1	CWH171039A	
	21	NUT - TERMINAL COVER	1	CWH7080300J	
	22	SOUND PROOF BOARD	1	CWH151428	
	23	SOUND PROOF MATERIAL	1	CWG302948	
	24	SENSOR CO - COMP TEMP	1	CWA50C2205	O
	25	CONTROL BOARD COVER - TOP	1	ACXH13-00450	
⚠	26	ELECTRONIC CONTROLLER - MAIN	1	ACXA73C39660R	O
⚠	27	TERMINAL BOARD ASSY	1	CWA28K1110J	O
	28	CABINET SIDE PLATE CO.	1	ACXE04C00460	
	29	SENSOR CO - AIR TEMP AND PIPE TEMP	1	CWA50C3079	O
	30	CABINET SIDE PLATE (LEFT)	1	CWE041858A	
	31	CABINET FRONT PLATE CO.	1	CWE06C1566	
	32	CABINET TOP PLATE	1	CWE031230A	
	33	PLATE - C. B. COVER TERMINAL	1	CWH131301	
	34	CONTROL BOARD COVER CO.	1	CWH13C1359	
	36	SOUND PROOF MATERIAL	1	CWG302316	
	38	4-WAYS VALVE	1	ACXB00-00130	O
⚠	39	V-COIL COMPLETE (4-WAY VALVE)	1	ACXA43C00250	O
	40	WIRE NET	1	ACXD04-00040A	
	41	BAG - COMPLETE	1	CWG87C900	
⚠	42	V-COIL COMPLETE (EXP. VALVE)	1	ACXA43C00640	O
	43	STRAINER	2	CWB111032	
	44	RECEIVER	1	CWB14011	
	46	PANASONIC BADGE	1	CWE373439	
	52	INSTALLATION INSTRUCTION	1	ACXF60-27460	
	53	INSTALLATION INSTRUCTION	1	ACXF60-27470	
	54	INSTALLATION INSTRUCTION	1	ACXF60-27480	
	55	INSTALLATION INSTRUCTION	1	ACXF60-27490	
	56	INSTALLATION INSTRUCTION	1	ACXF60-27500	

SAFETY	REF. NO.	PART NAME & DESCRIPTION	QTY.	CU-Z25UBEA	REMARK
	57	INSTALLATION INSTRUCTION	1	ACXF60-27510	
	58	INSTALLATION INSTRUCTION	1	ACXF60-27520	
	59	INSTALLATION INSTRUCTION	1	ACXF60-27530	
	60	INSTALLATION INSTRUCTION	1	ACXF60-27540	
	61	INSTALLATION INSTRUCTION	1	ACXF60-27550	
	62	INSTALLATION INSTRUCTION	1	ACXF60-27560	
	63	INSTALLATION INSTRUCTION	1	ACXF60-27570	
	64	INSTALLATION INSTRUCTION	1	ACXF60-27580	
	65	INSTALLATION INSTRUCTION	1	ACXF60-27590	
	66	INSTALLATION INSTRUCTION	1	ACXF60-27600	
	90	BAG	1	CWG861078	
	91	BASE BOARD-COMPLETE	1	CWG62C1223	
	92	SHOCK ABSORBER (L)	1	CWG713779	
	93	SHOCK ABSORBER (R)	1	CWG713778	
	94	C.C. CASE	1	ACXG50-06590	

(NOTE)

- All parts are supplied from PAPAMY, Malaysia (Vendor Code: 00029488).
- "O" marked parts are recommended to be kept in stock.

22.3.2 CU-Z35UBEA

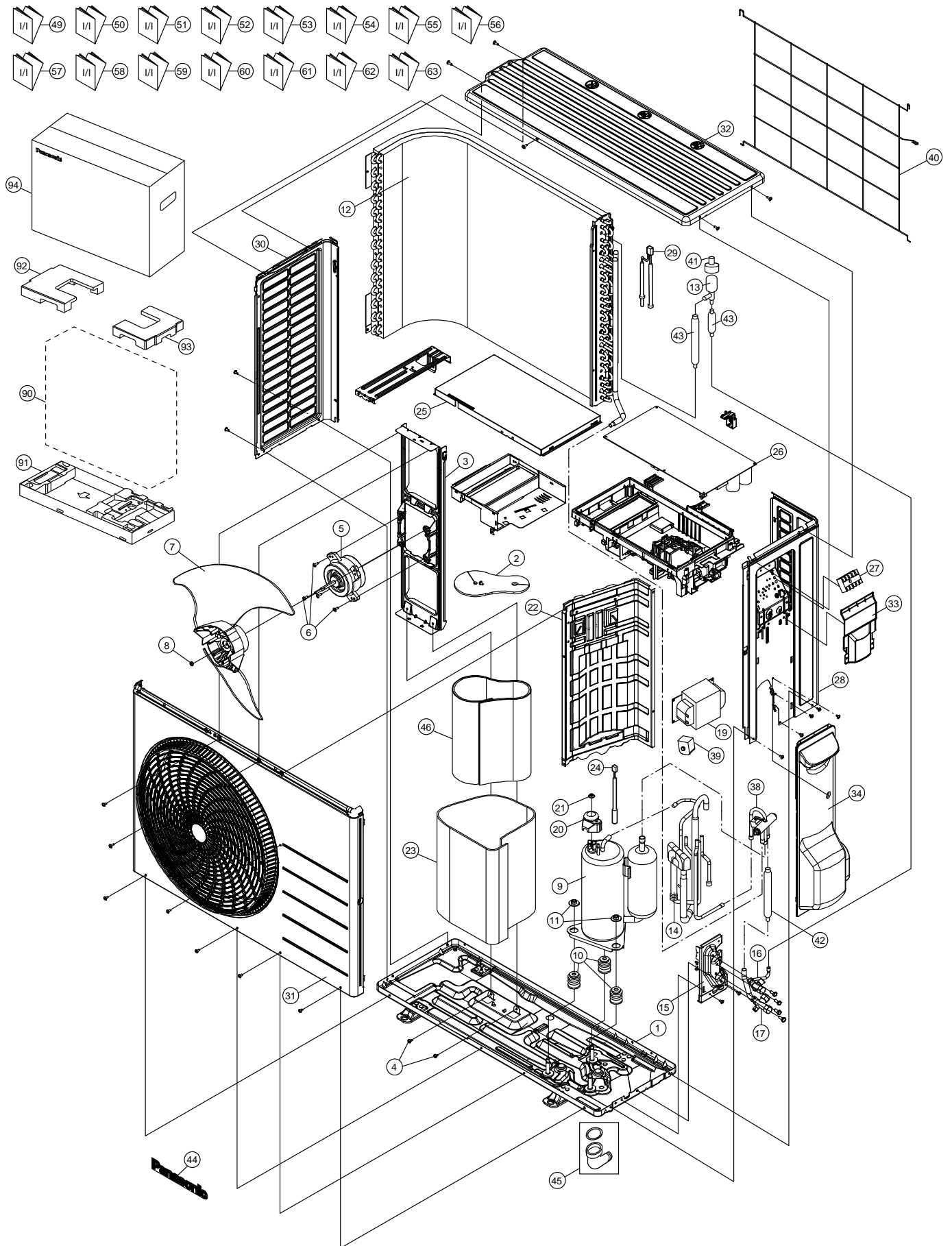

Note

The above exploded view is for the purpose of parts disassembly and replacement.
The non-numbered parts are not kept as standard service parts.

SAFETY	REF. NO.	PART NAME & DESCRIPTION	QTY.	CU-Z35UBEA	REMARK
	1	CHASSIS COMPLETE	1	CWD52K1277	
	2	SOUND PROOF MATERIAL (TOP)	1	CWG302719	
	3	FAN MOTOR BRACKET	1	CWD541167	
	4	SCREW - FAN MOTOR BRACKET	2	CWH551217	
⚠	5	FAN MOTOR	1	L6CAYYYL0064	O
	6	SCREW - FAN MOTOR MOUNT	4	CWH55252J	
	7	PROPELLER FAN ASSY	1	CWH03K1066	
	8	NUT - PROPELLER FAN	1	CWH56053J	
⚠	9	COMPRESSOR	1	9RS102XFA21	O
	10	ANTI - VIBRATION BUSHING	3	CWH50077	
	11	NUT - COMPRESSOR MOUNT	3	CWH561096	
	12	CONDENSER	1	CWB32C3547	
	13	EXPANSION VALVE	1	CWB051078	
	14	DISCHARGE MUFFLER (4 W.VALVE)	1	CWB121010	
	15	HOLDER COUPLING	1	CWH351233	
	16	2-WAYS VALVE (LIQUID)	1	ACXB02-02650	O
	17	3-WAY VALVE (GAS)	1	CWB011581	O
⚠	19	REACTOR	1	G0C392J00028	O
	20	TERMINAL COVER	1	CWH171039A	
	21	NUT - TERMINAL COVER	1	CWH7080300J	
	22	SOUND PROOF BOARD	1	ACXH15-01590	
	23	SOUND PROOF MATERIAL (BODY)	1	CWG302949	
	24	SENSOR CO - COMP TEMP	1	CWA50C2894	O
	25	CONTROL BOARD COVER - TOP	1	CWH131473	
⚠	26	ELECTRONIC CONTROLLER - MAIN	1	ACXA73C39670R	O
⚠	27	TERMINAL BOARD ASSY	1	CWA28K1110J	O
	28	CABINET SIDE PLATE CO. (RIGHT)	1	CWE04C1411	
	29	SENSOR CO - AIR TEMP AND PIPE TEMP	1	CWA50C3078	O
	30	CABINET SIDE PLATE	1	CWE041579A	
	31	CABINET FRONT PLATE CO.	1	ACXE06C02830	
	32	CABINET TOP PLATE	1	CWE031148A	
	33	PLATE - C. B. COVER TERMINAL	1	CWH131470	
	34	CONTROL BOARD COVER CO.	1	CWH13C1253	
	38	4-WAYS VALVE	1	ACXB00-00130	O
⚠	39	V-COIL COMPLETE (4 WAY VALVE)	1	ACXA43C00250	O
	40	WIRE NET	1	CWD041200A	
⚠	41	V-COIL COMPLETE (EXP. VALVE)	1	ACXA43C00640	O
	42	RECEIVER	1	CWB14011	
	43	STRAINER	2	CWB111032	
	44	PANASONIC BADGE	1	CWE373439	
	45	BAG - COMPLETE	1	CWG87C900	
	46	SOUND PROOF MATERIAL	1	CWG302701	
	49	INSTALLATION INSTRUCTION	1	ACXF60-27460	
	50	INSTALLATION INSTRUCTION	1	ACXF60-27470	
	51	INSTALLATION INSTRUCTION	1	ACXF60-27480	
	52	INSTALLATION INSTRUCTION	1	ACXF60-27490	
	53	INSTALLATION INSTRUCTION	1	ACXF60-27500	
	54	INSTALLATION INSTRUCTION	1	ACXF60-27510	
	55	INSTALLATION INSTRUCTION	1	ACXF60-27520	

SAFETY	REF. NO.	PART NAME & DESCRIPTION	QTY.	CU-Z35UBEA	REMARK
	56	INSTALLATION INSTRUCTION	1	ACXF60-27530	
	57	INSTALLATION INSTRUCTION	1	ACXF60-27540	
	58	INSTALLATION INSTRUCTION	1	ACXF60-27550	
	59	INSTALLATION INSTRUCTION	1	ACXF60-27560	
	60	INSTALLATION INSTRUCTION	1	ACXF60-27570	
	61	INSTALLATION INSTRUCTION	1	ACXF60-27580	
	62	INSTALLATION INSTRUCTION	1	ACXF60-27590	
	63	INSTALLATION INSTRUCTION	1	ACXF60-27600	
	90	BAG	1	ACXG86-03760	
	91	BASE BOARD-COMPLETE	1	CWG62C1144	
	92	SHOCK ABSORBER (L)	1	CWG713416	
	93	SHOCK ABSORBER (R)	1	CWG713415	
	94	C.C. CASE	1	CWG568358	

(NOTE)

- All parts are supplied from PAPAMY, Malaysia (Vendor Code: 00029488).
- "O" marked parts are recommended to be kept in stock.

22.3.3 CU-Z50UBEA CU-Z60UBEA

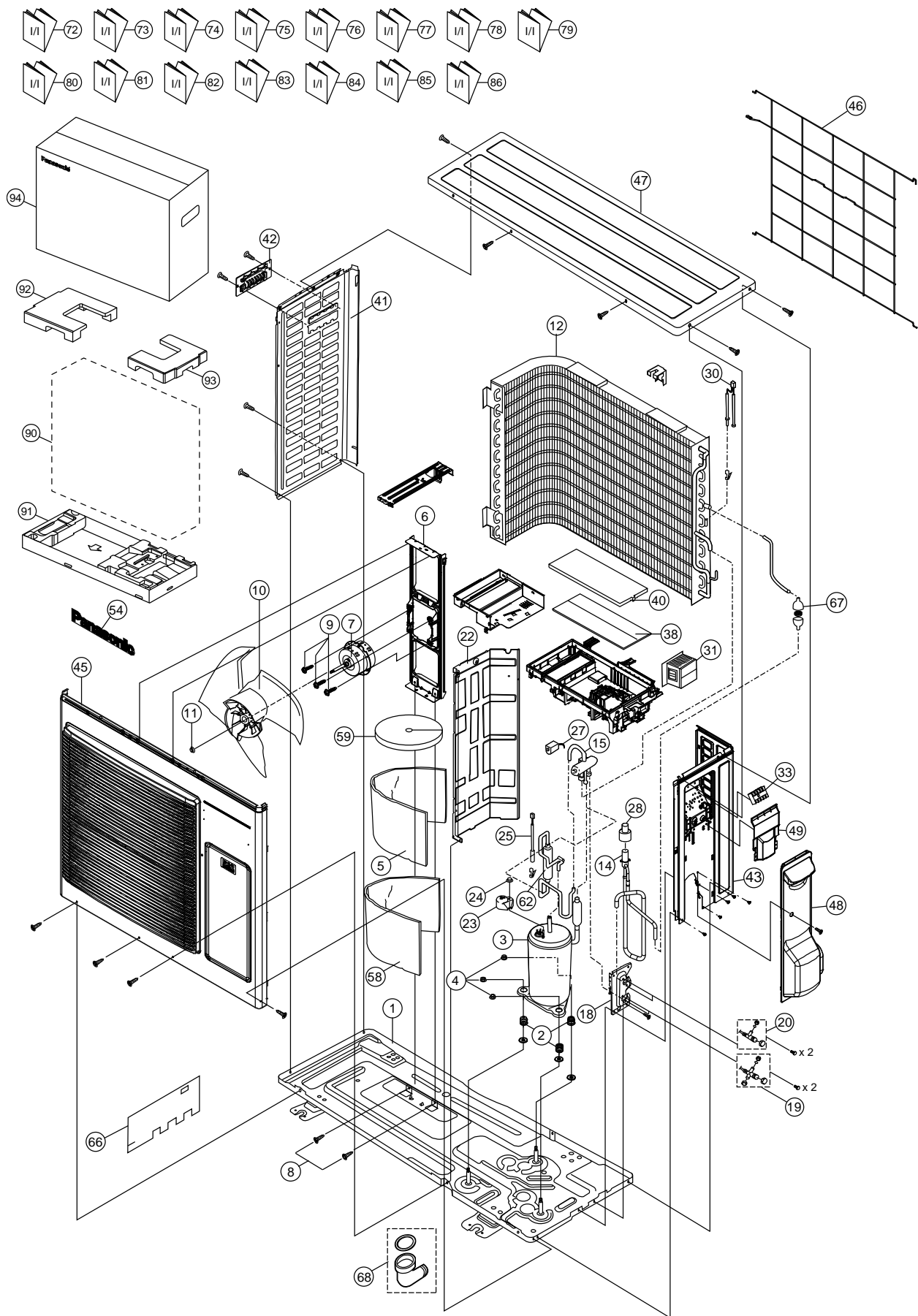

Note
 The above exploded view is for the purpose of parts disassembly and replacement.
 The non-numbered parts are not kept as standard service parts.

SAFETY	REF. NO.	PART NAME & DESCRIPTION	QTY.	CU-Z50UBEA	CU-Z60UBEA	REMARK
	1	CHASSIS COMPLETE	1	ACXD52K00320	←	
	2	ANTI - VIBRATION BUSHING	3	CWH50077	←	
⚠	3	COMPRESSOR	1	9RD132XAA21	←	O
	4	NUT - COMPRESSOR MOUNT	3	CWH561096	←	
	5	SOUND PROOF MATERIAL	1	CWG302950	←	
	6	FAN MOTOR BRACKET	1	ACXD54-00140	←	
⚠	7	FAN MOTOR	1	L6CAYYYL0076	←	O
	8	SCREW - FAN MOTOR BRACKET	2	CWH551217	←	
	9	SCREW - FAN MOTOR MOUNT	4	CWH551106J	←	
	10	PROPELLER FAN ASSY	1	ACXH03K00070	←	
	11	NUT - PROPELLER FAN	1	CWH56053J	←	
	12	CONDENSER	1	ACXB32C08610	←	
	14	EXPANSION VALVE	1	CWB051078	←	
	15	4-WAYS VALVE	1	ACXB00-00140	←	O
	18	HOLDER COUPLING	1	ACXH35-00080	←	
	19	3-WAY VALVE (GAS)	1	ACXB01-00580	←	O
	20	2-WAYS VALVE (LIQUID)	1	ACXB02-00210	←	O
	22	SOUND PROOF BOARD	1	ACXH15-00200	←	
	23	TERMINAL COVER	1	CWH171039A	←	
	24	NUT - TERMINAL COVER	1	CWH7080300J	←	
	25	SENSOR CO - COMP. TEMP.	1	CWA50C2185	←	O
⚠	27	V-COIL COMPLETE (4-WAY VALVE)	1	ACXA43C00250	←	O
⚠	28	V-COIL COMPLETE (EXP. VALVE)	1	ACXA43C00640	←	O
	30	SENSOR - COMPLETE (AIR & PIPE TEMP.)	1	CWA50C3079	←	
⚠	31	REACTOR	1	G0C392J00027	G0C392J00029	O
⚠	33	TERMINAL BOARD ASSY	1	CWA28K1110J	←	O
⚠	38	ELECTRONIC CONTROLLER - MAIN	1	ACXA73C39680R	ACXA73C39690R	O
	40	CONTROL BOARD COVER - TOP	1	ACXH13-00490	←	
	41	CABINET SIDE PLATE (LEFT)	1	ACXE04-00580	←	
	42	HANDLE	1	CWE161010	←	
	43	CABINET SIDE PLATE (RIGHT)	1	ACXE04C00720	←	
	45	CABINET FRONT PLATE CO.	1	ACXE06K00050	←	
	46	WIRE NET	1	ACXD04-00130A	←	
	47	CABINET TOP PLATE	1	ACXE03-00170A	←	
	48	CONTROL BOARD COVER - COMPLETE	1	ACXH13C00170	←	
	49	CONTROL BOARD COVER	1	CWH131470	←	
	54	PANASONIC BADGE	1	CWE373439	←	
	58	SOUND PROOF MATERIAL	1	CWG302636	←	
	59	SOUND PROOF MATERIAL	1	CWG302630	←	
	62	RECEIVER	1	CWB14011	←	
	66	SOUND PROOF MATERIAL	1	CWG302632	←	
	67	STRAINER	1	CWB11094	←	
	68	BAG - COMPLETE	1	CWG87C900	←	
	72	INSTALLATION INSTRUCTION	1	ACXF60-27460	←	
	73	INSTALLATION INSTRUCTION	1	ACXF60-27470	←	
	74	INSTALLATION INSTRUCTION	1	ACXF60-27480	←	
	75	INSTALLATION INSTRUCTION	1	ACXF60-27490	←	
	76	INSTALLATION INSTRUCTION	1	ACXF60-27500	←	
	77	INSTALLATION INSTRUCTION	1	ACXF60-27510	←	

SAFETY	REF. NO.	PART NAME & DESCRIPTION	QTY.	CU-Z50UBEA	CU-Z60UBEA	REMARK
	78	INSTALLATION INSTRUCTION	1	ACXF60-27520	←	
	79	INSTALLATION INSTRUCTION	1	ACXF60-27530	←	
	80	INSTALLATION INSTRUCTION	1	ACXF60-27540	←	
	81	INSTALLATION INSTRUCTION	1	ACXF60-27550	←	
	82	INSTALLATION INSTRUCTION	1	ACXF60-27560	←	
	83	INSTALLATION INSTRUCTION	1	ACXF60-27570	←	
	84	INSTALLATION INSTRUCTION	1	ACXF60-27580	←	
	85	INSTALLATION INSTRUCTION	1	ACXF60-27590	←	
	86	INSTALLATION INSTRUCTION	1	ACXF60-27600	←	
	90	BAG	1	CWG861461	←	
	91	BASE BOARD-COMPLETE	1	CWG62C1131	←	
	92	SHOCK ABSORBER (L)	1	CWG713217	←	
	93	SHOCK ABSORBER (R)	1	CWG713218	←	
	94	C.C. CASE	1	CWG568359	←	

(NOTE)

- All parts are supplied from PAPAMY, Malaysia (Vendor Code: 00029488).
- "O" marked parts are recommended to be kept in stock.